



www. CREST EAST COAST .com
866-458-9009

EZ-WARE FLEXSYS - 2017



**HARDWARE
AND
AUTOMOTIVE
BULBS**

TO SEARCH BY DESCRIPTION PRESS
(CTRL+F) SIMULTANEOUSLY AND
ENTER THE SEARCH WORD IN THE
DIALOG BOX



EZ-WARE
LESS IS BETTER



EZ-WARE FLEXSYS HOT RACK 160 - 2017



	SECTION	PAGE
1	8 Drawer Lid Labels	2 -17
2	Hot Box - Bulk Pack	18 -19
3	Oldies bur Goodies	20 - 26
4	Hardware Supplement	27
5	Ergo Tufloks	28
6	Hot Box / Japanese HB	29
7	Mini Drawer Lid Labels	30
8	Hot Rack Disc. & Offers	31 - 32
9	EZ Ware Reorder Form	33
10	Drawer & Bin Locater	34
11	Purchase Agreement	35

EZ-WARE "FLEXSYS" HOT RACK 160

A modern "FLEXIBLE" hardware storage system, consisting of 8 pre-labeled drawer assortments with 160 illustrations on the drawer lid labels of the LATEST TOP SELLING hardware numbers essential to repair the late model and new vehicles in your shop!









JUST IMAGINE - NO "DEAD" NUMBERS!!!





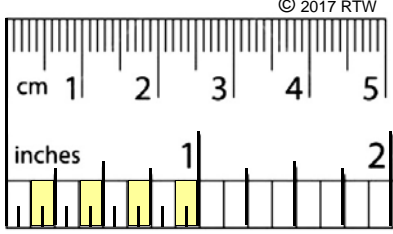

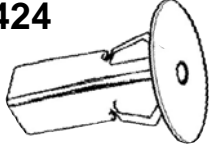
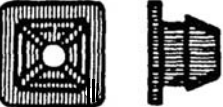
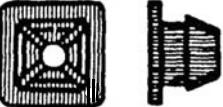





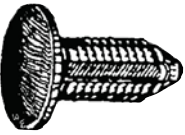

NUTS & NAILS

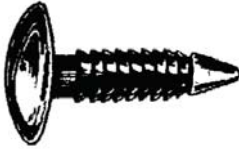
GROMMET & RETAINERS ASSORTMENT

<p># Y2716 1</p>  <p>RADIATOR GRILLE NUT #8 SCREW ZINC PHOSPHATE GM TRUCKS- '93 & UP</p> <p>UNIT PKG.-25 187</p>	<p># Y29300 2</p>  <p>PLASTIC SCREW GROMMET ROCKER MLDNG & PILLAR FOR 9 MM SQ. HOLE 17 MM HEAD DIAM. 10 MM STEM LENGTH FOR #12 SCREW TOYOTA/LEXUS-'07 & UP</p> <p>UNIT PKG.-25 64</p>	<p># Y4824 3</p>  <p>BUMPER FASCIA RETAINER GM, FORD, AMC, CHR YSLER '85 & UP UNIT PKG.-50</p> <p>HOLE SIZE-10MM HEAD DIAM.-21MM STEM-28MM 43</p>
<p># Y3144 7</p>  <p>NYLON SCREW GROMMET 13mm SQ.HD; #10 SCREW 10mm O/A HT; FOR 9mm HOLE MAZDA, HONDA, NISSAN AND TOYOTA</p> <p>UNIT PKG.-25 55</p>	<p># Y19900 8</p>  <p>PLASTIC FENDER LINER RETAINER HONDA & ACURA 2004 & UP</p> <p>SQ HOLE SIZE-9 MM HEAD DIAM.- 20 MM O/A LENGTH-14 MM</p> <p>UNIT PKG.-25 64</p>	<p># Y19900 9</p>  <p>© 2017 RTW</p>
<p># Y29462 13</p>  <p>PLASTIC SCREW GROMMET WITH SEALER FOR 8 MM SQ. HOLE 16 MM HEAD DIAM. 22 MM O/A LENGTH FOR #8 SCREW NISSAN/INFINITY</p> <p>UNIT PKG.-15 48</p>	<p># Y15424 14</p>  <p>SCREW GROMMET #12 SCREW 8 MM SQUARE HOLE 20 MM HEAD; 22 MM LENGTH TOYOTA</p> <p>UNIT PKG.-15 59</p>	<p># Y9808 19</p>  <p>LICENSE PLATE NUT UNIVERSAL (USE #14 SCREWS)</p> <p>UNIT PKG.-50 51</p>
<p># Y9808 19</p>  <p>LICENSE PLATE NUT UNIVERSAL (USE #14 SCREWS)</p> <p>UNIT PKG.-50 51</p>	<p># Y3174 20</p>  <p>(REPLACES-TOY.-90189-06065) (29818-474D3; 96706-W1000) PLASTIC GROMMET FENDER SHIELD 6 MM SCREW SIZE 20 MM HEAD, 8 X 8 MM HOLE TOYOTA</p> <p>UNIT PKG.-25 360</p>	<p># Y3174 21</p>  <p>(REPLACES-TOY.-90189-06065) (29818-474D3; 96706-W1000) PLASTIC GROMMET FENDER SHIELD 6 MM SCREW SIZE 20 MM HEAD, 8 X 8 MM HOLE TOYOTA</p> <p>UNIT PKG.-25 360</p>

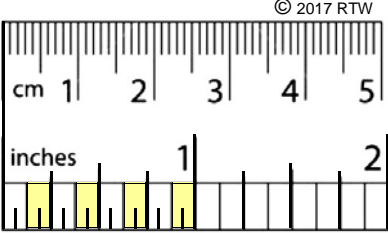

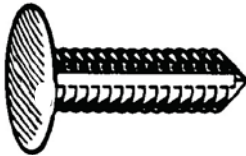
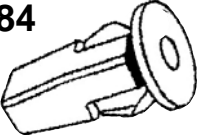
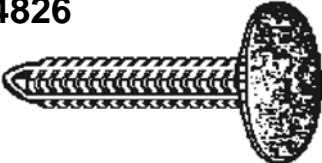





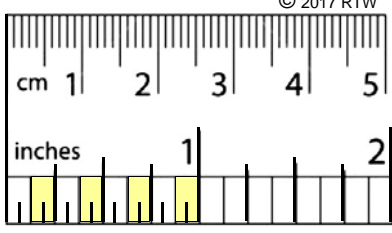

NUTS & NAILS GROMMET & RETAINERS ASSORTMENT

<p># Y4814 4</p>  <p>TRIM PANEL CLIP FORD -'93&UP, CHRYSLER-95'&UP UNIT PKG.-50 HOLE SIZE-5/16", HEAD DIAM.-5/8" 73 STEM-3/4"</p>	<p># Y15422 5</p>  <p>PLASTIC HOOD INSULATION RE-TAINER TOYOTA CAMRY & SOLARA, LEXUS- '98 & UP UNIT PKG.-15</p> <div style="border: 1px solid black; padding: 2px; width: fit-content; margin: 5px auto;"> <p>HOLE SIZE-7 MM; HEAD DIAM.-25 MM; STEM-10 MM</p> </div> <p style="text-align: right;">124</p>	<p># Y130 6</p>  <p>PLASTIC SHIELD CLIP (LONGER THAN #Y4520) UNIT PKG.-50 HOLE SIZE-1/4", HEAD DIAM.-11/16" STEM-1-1/16"</p> <p style="text-align: right;">130</p>
<p>#Y500 10</p>  <p>TRIM PANEL & WHEEL WELL RETAINER GM (SATURN)-'91 & UP CHRYSLER VANS-'87 & UP UNIT PKG.-25</p> <p style="text-align: right;">146</p>	<p># Y463 11</p>  <p>PANEL FASTENER RADIATOR SKIRT ATTACHING CADILLAC & GM, UNIT PKG.-25 HOLE SIZE-13/32" HEAD DIAM.-1" STEM LENGTH-13/16"</p> <p style="text-align: right;">85</p>	<p># Y9136 12</p>  <p>1/4" (6.4mm) Hole Size 1 21/32" O.D. Head Size Black Nylon Hood Insulation Clips UNIT PKG.-25</p> <p style="text-align: right;">54</p>
<p style="text-align: right;">16</p>  <p style="text-align: center; font-size: small;">© 2017 RTW</p>	<p># Y18682 17</p>  <p>HOOD INSULATION RETAINER KIA & HYUNDAI 1996 & UP UNIT PKG.-15</p> <div style="border: 1px solid black; padding: 2px; width: fit-content; margin: 5px auto;"> <p>HOLE SIZE-8 MM HEAD DIAM.-26 MM OVERALL HEIGHT- 16 MM</p> </div> <p style="text-align: right;">46</p>	<p># Y9014 18</p>  <p>INTERIOR TRIM CLIP-BLACK GM, FORD & UNIVERSAL UNIT PKG.-25 HOLE SIZE-7MM / HEAD DIAM.20MM GRIP RANGE-30MM</p> <p style="text-align: right;">189</p>
<p># Y12784 22</p>  <p>SCREW GROMMET FENDER SHIELD FOR 9 MM SQUARE HOLE FLANGE DIAMETER 16 MM FOR #12 SCREW TOYOTA-'92 & UP-TACOMA, 4-RUNNER, T-100;GM-'85 & UP CHEVY. & PONTIAC UNIT PKG.-15</p> <p style="text-align: right;">107</p>	<p># Y4826 23</p>  <p>BLACK TEXTURED HEAD PANEL RETAINERS HOLE SIZE 9/32" (7.1MM) UNIT PKG.-25</p> <p style="text-align: right;">60</p>	<p># Y4520 24</p>  <p>SCREW NAIL RETAINER GM, FORD, CHRYSLER, AMC, UNIT PKG.-100 (3/16" LONGER THAN #Y4620)</p> <p style="text-align: right;">214</p>

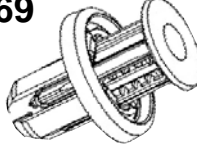
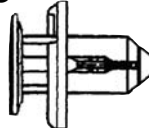
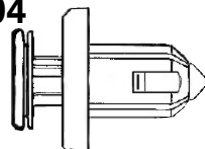
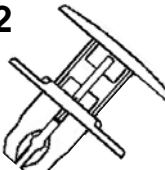

PLASTIC PUSH RIVETS ASSORTMENT

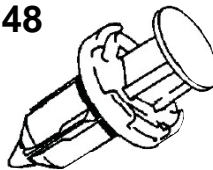
<p># Y20800  1</p> <p>PLASTIC PUSH RIVET ROCKER MOULDING, FENDER LINER, RADIATOR SPLASH SHIELD, & INTERIOR TRIM PANEL INFINITY & NISSAN 2003 & UP UNIT PKG.-10</p> <p>HOLE SIZE-8 MM HEAD DIAM.-20 MM STEM LENGTH-12 MM</p> <p>57</p>	<p># Y18692  2</p> <p>PLASTIC PUSH RIVET FENDER LINER TOYOTA/LEXUS- 2007 & UP GM-PONTIAC VIBE</p> <p>HOLE SIZE-7 MM HEAD DIAM.-18 MM STEM LENGTH-7 MM</p> <p>UNIT PKG.-10</p> <p>56</p>	<p>3</p> <p>© 2017 RTW</p> 
<p># Y14024  7</p> <p>PUSH TYPE RETAINER FRONT FENDER TOYOTA TERCEL-'94 & UP UNIT PKG.-15</p> <p>HOLE SIZE-7 MM; HD. DIAM.-20 MM STEM-8 MM</p> <p>340</p>	<p># Y12766  8</p> <p>PUSH TYPE RETAINER-FRONT FENDER NISSAN MAXIMA, 300ZX-'94 & UP UNIT PKG.-15</p> <p>HOLE SIZE-8 MM; HEAD. DIAM.-20 MM STEM-9 MM; PANEL RANGE-4 MM</p> <p>330</p>	<p># Y12264  9</p> <p>PLASTIC PUSH RIVET FRONT FENDER LINER HONDA-CIVIC AND DEL SOL- '93 & UP UNIT PKG.-15</p> <p>HOLE SIZE-8 MM; HD. DIAM.-20 MM</p> <p>286</p>
<p># Y11069  13</p> <p>(91505-TM8-0030) PLASTIC PUSH RIVET-GRILLE & BUMPER COVER RETAINER HONDA-ACCORD, INSIGHT & CROSSTOUR-2012-UP UNIT PKG.-15</p> <p>HOLE SIZE-10 MM FLANGE DIAM.-20 MM STEM LENGTH-14 MM</p> <p>55</p>	<p># Y17778  14</p> <p>PLASTIC PUSH RIVET- GRILLE & BUMPER FASCIA NISSAN-'94 AND UP UNIT PKG.-15</p> <p>HEAD DIAMETER-18 MM STEM LENGTH-10 MM FOR 8 MM HOLE</p> <p>291</p>	<p># Y20604  15</p> <p>PLASTIC BUMPER COVER RETAINER- (WITH METAL INSERT) HONDA-ACCORD, CIVIC, CRV & ELEMENT- ACURA 2006 & UP UNIT PKG.-10</p> <p>HOLE SIZE-10 MM FLANGE DIAM.-20 MM PIN LENGTH-25.5 MM</p> <p>188</p>
<p># Y29472  19</p> <p>(91501-TR0-003) PLASTIC PUSH RIVET FENDER LINER & GRILLE CLIP HONDA/ACURA-RDX, CIVIC & ACCORD-2012-UP UNIT PKG.-25</p> <p>HOLE SIZE-8 MM HD.DIAM.-20 MM STEM LENGTH-10 MM</p> <p>57</p>	<p># Y4282  20</p> <p>(86590-28000) PLASTIC SCREW RIVET FENDER LINER, BUMPER COVER, GRILLE, & SPLASH SHIELD RETAINER HYUNDAI- KIA- 2005 & UP UNIT PKG.-10</p> <p>FOR 8 MM HOLE FLANGE O.D.-18 MM OVERALL LENGTH-18 MM</p> <p>72</p>	<p># Y17148  21</p> <p>PLASTIC PUSH RIVET BUMPER COVER & TRIM RETAINER HONDA, MITSUBISHI, CHRYSLER-'97 & UP UNIT PKG.-15</p> <p>FLANGE DIAMETER-18 MM STEM LENGTH-13 MM FOR 9 MM HOLE</p> <p>137</p>





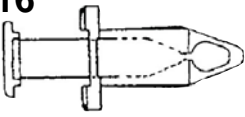
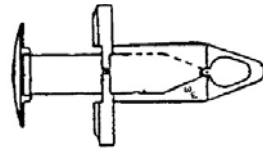
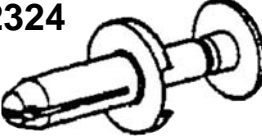
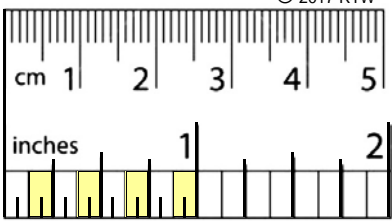
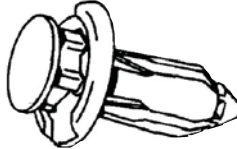
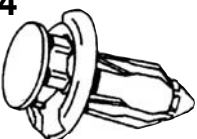
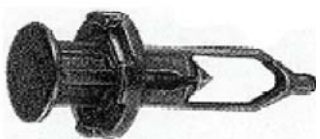
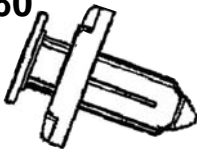
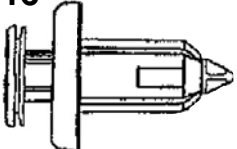
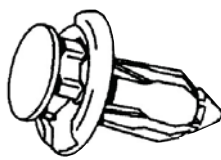





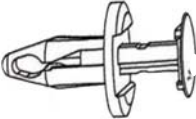

PLASTIC PUSH RIVETS ASSORTMENT

<p># Y11904 4</p>  <p>PLASTIC PUSH RIVET FRONT FENDER HONDA/ ACURA-'94 & UP UNIT PKG.-25</p> <p>HOLE SIZE-8MM: HD. DIAM.-20MM OVERALL LENGTH- 13.4 MM</p> <p style="text-align: right;">248</p>	<p># Y5116 5</p>  <p>NYLON PUSH RIVET GM (SATURN), TRUCK UNIT PKG.-25</p> <p>HOLE SIZE-8MM: HD. DIAM.-15MM PANEL RANGE-3-8 MM</p> <p style="text-align: right;">103</p>	<p># Y5114 6</p>  <p>NYLON PUSH RIVET GM (SATURN), C,K TRUCK FORD, CHRYSLER UNIT PKG.-25</p> <p>HOLE SIZE-8MM: HD. DIAM.-20MM PANEL RANGE-3-8 MM</p> <p style="text-align: right;">339</p>
<p># Y12324 10</p>  <p>(CHRYSLER/DODGE-6504521) PLASTIC DRIVE RIVET FRONT & REAR FASCIA-'98-UP UNIT PKG.-25</p> <p>HOLE SIZE-8.5 MM HD. DIAM.-16 MM STEM LENGTH-23 MM</p> <p style="text-align: right;">77</p>	<p style="text-align: center;">© 2017 RTW</p> 	<p># Y13776 12</p>  <p>PLASTIC PUSH RIVET FRONT GRILLE AND BUMPER HONDA- '98 & UP UNIT PKG.-15</p> <p>HOLE SIZE-10 MM FLANGE OD-20 MM; STEM-17 MM</p> <p style="text-align: right;">310</p>
<p style="text-align: center;">16</p>	<p># Y11244 17</p>  <p>PLASTIC PUSH- RIVET RETAINER FRONT GRILLE AND BUMPER NISSAN- '94 & UP UNIT PKG.-15</p> <p>HOLE SIZE-10 MM HEAD DIAM-18 MM STEM LENGTH-15 MM</p> <p style="text-align: right;">226</p>	<p># Y8698 18</p>  <p>PLASTIC PUSH RIVET REAR BUMPER COVER RETAINER TOYOTA-TERCEL-'88 & UP UNIT PKG.-4</p> <p>HOLE SIZE-9 MM; HD. DIAM.-18 MM</p> <p style="text-align: right;">199</p>
<p># Y19160 22</p>  <p>PLASTIC PUSH RIVET BUMPER & RADIATOR 20 MM HEAD, 13 MM STEM FOR 8 MM HOLE NISSAN- 2002 & UP UNIT PKG.-25</p> <p style="text-align: right;">391</p>	<p># W3246 23</p>  <p>PLASTIC PUSH RIVET W/METAL INSERT GRILLE, BUMPER COVER, FENDER LINER & SPLASH SHIELD HONDA/ACURA-2006 & UP UNIT PKG.-10</p> <p>HOLE SIZE-10 MM HEAD DIAM.-20 MM PIN LENGTH-30 MM</p> <p style="text-align: right;">166</p>	<p># Y11644 24</p>  <p>PLASTIC PUSH RIVET FRONT GRILLE AND BUMPER HONDA- '96 & UP UNIT PKG.-15</p> <p>HOLE SIZE-10 MM; FLANGE O.D.-20 MM STEM-13 MM</p> <p style="text-align: right;">287</p>

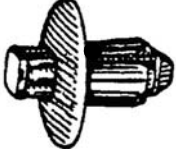
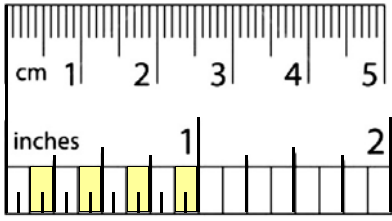





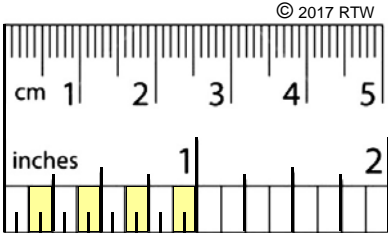

U-NUT / PUSH & SCREW RIVET ASSORTMENT

<p># Y19262 1</p>  <p>(47749-58010) PLASTIC PIN-FRONT FENDER & BUMPER COVER TOYOTA 4 RUNNER, SOLARA, HIGHLANDER, & SIENNA LEXUS-GX 470- 2000 & UP</p> <p>HEAD DIAM.-16 MM OVERALL LENGTH-28 MM</p> <p style="text-align: right;">124</p> <p style="text-align: center;">UNIT PKG.-10</p>	<p># Y4128 2</p>  <p>(HONDA- 91545-SEO-0030-W1) (NISSAN-63848-01G00) PUSH RIVET-HONDA, NISSAN UNIT PKG.-25</p> <p>HOLE SIZE-8 MM; HD.DIAM.-20MM</p> <p style="text-align: right;">46</p>	<p># Y3098 3</p>  <p>EXPANSION SCREW RIVET PANEL RETAINER TOYOTA & MAZDA UNIT PKG.-15</p> <p>HOLE SIZE-7 MM FLANGE-15 MM; STEM- 12 MM</p> <p style="text-align: right;">96</p>
<p># Y19264 7</p>  <p>PLASTIC RETAINER-FRONT FENDER & BUMPER COVER TOYOTA 4 RUNNER, SOLARA, HIGHLANDER & SIENNA LEXUS-GX 470 2000 & UP</p> <p style="text-align: right;">129</p> <p style="text-align: center;">UNIT PKG.- 5</p>	<p># Y3104 8</p>  <p>(NISSAN-809905N07, 01553-00755) (TOY.-90467-07043) BUMPER PUSH RIVET UNIT PKG.-25</p> <p>HOLE SIZE-7 MM HD. DIAM.-18 MM</p> <p style="text-align: right;">73</p>	<p># Y15704 9</p>  <p>WHEEL OPENING, COWL VENT GM (SATURN), FORD UNIT PKG.-25</p> <p>HOLE SIZE-6.3 MM FLANGE OD-15 MM; PANEL RANGE-2-6 MM</p> <p style="text-align: right;">140</p>
<p># Y29119 13</p>  <p>PLASTIC PIN (USE WITH BELOW) FRONT BUMPER COVER & FENDER LINER TOYOTA - LEXUS-GS,IS,& LS MODELS - 2008 & UP</p> <p style="text-align: right;">66</p> <p style="text-align: center;">UNIT PKG.- 15</p>	<p># Y4434 14</p>  <p>PUSH RIVET- BUMPER COVER NISSAN MAXIMA INFINITY UNIT PKG.-15</p> <p>HOLE SIZE-8 MM; HD. DIAM.-20 MM</p> <p style="text-align: right;">177</p>	<p style="text-align: right;">15</p>  <p style="text-align: right;">© 2017 RTW</p>
<p># Y29120 19</p>  <p>PLASTIC RETAINER (USE WITH ABOVE) FRONT BUMPER COVER & FENDER LINER TOYOTA-LEXUS-GS,IS, & LS UNIT PKG.- 10</p> <p style="text-align: right;">62</p>	<p># Y3110 20</p>  <p>BLACK NYLON "U" NUT FENDER, WHEELHOUSE TOYOTA UNIT PKG.-15</p> <p style="text-align: right;">54</p>	<p># Y3114 21</p>  <p>BLACK NYLON "U" NUT FENDER, WHEELHOUSE TOYOTA UNIT PKG.-15</p> <p style="text-align: right;">42</p>

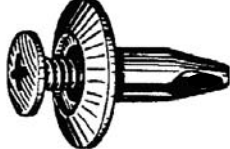

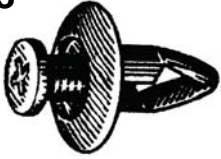
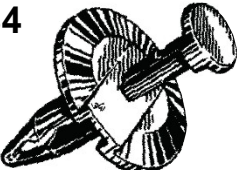
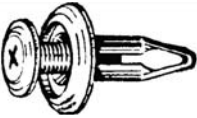
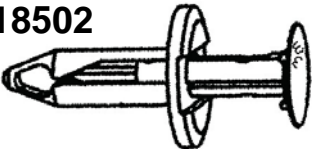
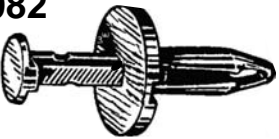









U-NUT / PUSH & SCREW RIVET ASSORTMENT

<p style="text-align: right;">4</p> 	<p style="text-align: right;">5</p> <p># Y4420</p>  <p>SCREW RIVET COWL PANEL TO REINFORCEMENT PLATE; NISSAN UNIT PKG.-25</p> <p>HOLE SIZE-6 MM: HD.DIAM.-14 MM</p> <p style="text-align: right;">65</p>	<p style="text-align: right;">6</p> <p># Y471</p>  <p>TRIM RETAINER GM, FORD, CHRYSLER UNIT PKG.-25</p> <p>HOLE SIZE-6.3MM: HD.DIAM.-18 MM</p> <p style="text-align: right;">174</p>
<p># Y6986</p>  <p>SCREW RIVET FENDER SPLASH SHIELD HONDA ACCORD '90 & UP UNIT PKG.-10</p> <p>HOLE SIZE-8 MM: HD.DIAM.-20 MM STEM LENGTH- 9 MM</p> <p style="text-align: right;">196</p>	<p style="text-align: right;">11</p> <p># Y473</p>  <p>EXPANSION SCREW RIVET INNER FENDER SHIELD NISSAN & UNIVERSAL UNIT PKG.-25</p> <p>HOLE SIZE-8 MM: HD.DIAM.-20 MM</p> <p style="text-align: right;">213</p>	<p style="text-align: right;">12</p>
<p># Y5084</p>  <p>DRIVE RIVET-BUMPER FASCIA GENERAL USE (GM, FORD, CHRYSLER) UNIT PKG.-25</p> <p>HOLE SIZE-7 MM HD. DIAM.-25 MM</p> <p style="text-align: right;">43</p>	<p style="text-align: right;">17</p> <p># Y4792</p>  <p>PLASTIC SCREW RIVET EXT. COMPONENT RETAINER FORD, GM & CHRYSLER UNIT PKG.-50</p> <p>HOLE SIZE-6.3 MM: HD.DIAM.-16 MM</p> <p style="text-align: right;">93</p>	<p style="text-align: right;">18</p> <p># Y18502</p>  <p>PLASTIC PUSH RIVET-BUMPER COVER & FENDER SHIELD GM & FORD-'97 & UP UNIT PKG.-15</p> <p>HOLE SIZE-8 MM; FLANGE DIAM.-20MM PANEL RANGE-3- 12 MM</p> <p style="text-align: right;">152</p>
<p># Y5082</p>  <p>(REPLACES-CHRYSLER-.6501925) PLASTIC DRIVE RIVET GM, FORD, AMC & CHRYSLER UNIT PKG.-25</p> <p>HOLE SIZE-6.3 MM HD. DIAM.-17.5 MM</p> <p style="text-align: right;">101</p>	<p style="text-align: right;">23</p> <p># Y20464</p>  <p>BLACK PLASTIC SCREW RIVET BUMPER COVER RETAINER</p> <p>FOR 5 MM HOLE HEAD DIAMETER 10 MM OVERALL BASE LENGTH-10 MM</p> <p>UNIT PKG.-10</p> <p style="text-align: right;">146</p>	<p style="text-align: right;">24</p> <p># Y20594</p>  <p>PLASTIC PUSH RIVET RADIATOR SEAL, SIGHT SHIELD, & GRILLE RETAINER TOYOTA/LEXUS-2005 & UP</p> <p>HOLE SIZE-7 MM FLANGE-19 MM OVERALL PIN LENGTH-18 MM</p> <p>UNIT PKG.-10</p> <p style="text-align: right;">99</p>

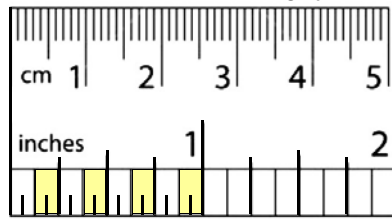

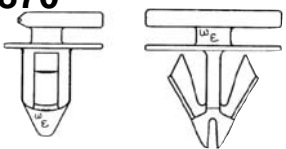





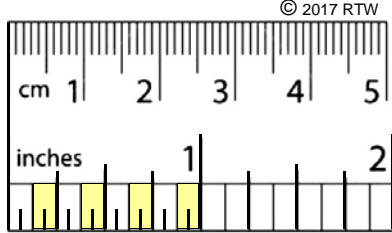

WEATHERSTRIP & PLASTIC RETAINERS ASSORTMENT

<p># Y4058 1</p>  <p>(HONDA- 90664-671-0030) (REPLACES-NISSAN-80833-S5000) WEATHERSTRIP RETAINER UNIT PKG.-50</p> <div style="border: 1px solid black; padding: 2px; width: fit-content;"> <p>HOLE SIZE-4 MM HEAD SIZE-7 X 16 MM OVERALL HT.-13 MM</p> </div> <p style="text-align: right;">45</p>	<p style="text-align: center;">2</p>	<p># Y9794 3</p>  <p>WEATHERSTRIP RETAINER FORD & HONDA UNIT PKG.-25</p> <div style="border: 1px solid black; padding: 2px; width: fit-content;"> <p>HOLE SIZE-5 MM HEAD SIZE-5 X 15 MM STEM-10 MM</p> </div> <p style="text-align: right;">209</p>
<p># Y12518 7</p>  <p>WEATHERSTRIP RETAINER HONDA- CIVIC DOORS-'95 & UP ODYSSEY HOOD SEAL-'99 & UP ACURA-'96 & UP UNIT PKG.-10</p> <div style="border: 1px solid black; padding: 2px; width: fit-content;"> <p>HOLE SIZE- 6 MM; HEAD - 5 X 15 MM OVERALL LENGTH-12 MM</p> </div> <p style="text-align: right;">65</p>	<p># Y6546 8</p>  <p>WEATHERSTRIP RETAINER GM (SATURN), CHRYSLER UNIT PKG.-50</p> <div style="border: 1px solid black; padding: 2px; width: fit-content;"> <p>HOLE SIZE-4 MM HEAD SIZE-7 X 17 MM OVERALL HT.-14 MM</p> </div> <p style="text-align: right;">159</p>	<p># Y25699 9</p>  <p>PLASTIC WEATHERSTRIP RETAINER MAZDA-'04 & UP UNIT PKG.-25</p> <div style="border: 1px solid black; padding: 2px; width: fit-content;"> <p>FOR 4 MM HOLE; 9 MM HD DIAM.; 7 MM STEM LENGTH</p> </div> <p style="text-align: right;">205</p>
<p># Y18324 13</p>  <p>PLASTIC INTERIOR TRIM PANEL RETAINER WITH SEALER TOYOTA/LEXUS 2001 & UP UNIT PKG.-15</p> <div style="border: 1px solid black; padding: 2px; width: fit-content;"> <p>HOLE SIZE-8.5 MM OVERALL HEIGHT-20 MM TOP HD. DIAMETER-13 MM</p> </div> <p style="text-align: right;">57</p>	<p style="text-align: center;">14</p> <p style="text-align: center;">© 2017 RTW</p> 	<p># Y6116 15</p>  <p>PLASTIC RETAINER REMOTE CONTROL DOOR LOCK RECIEVER AND UNIVERSAL, UNIT PKG.-100</p> <p>HOLE SIZE-4MM, HEAD DIAM.-9MM PANEL RANGE-0.8-6MM</p> <p style="text-align: right;">68</p>
<p># Y15870 19</p>  <p>PLASTIC ROCKER PANEL MOULDING RETAINER GM-'95 & UP UNIT PKG.-25</p> <div style="border: 1px solid black; padding: 2px; width: fit-content;"> <p>HOLE SIZE-9 MM TOP HEAD DIAM.-14 X 20 MM OVERALL HEIGHT-20 MM</p> </div> <p style="text-align: right;">65</p>	<p># Y19462 20</p>  <p>MOULDING RETAINER- SIDE AND FENDER TOYOTA, LEXUS 2003 & UP BLUE PLASTIC UNIT PKG.- 10</p> <div style="border: 1px solid black; padding: 2px; width: fit-content;"> <p>HOLE SIZE-9 MM SQUARE HEAD DIAM.-17 MM OVERALL HEIGHT-17 MM</p> </div> <p style="text-align: right;">53</p>	<p># Y19272 21</p>  <p>8mm Hole Size Top Head Diameter: 13mm Stem Length: 15mm White Nylon Door Panel Retainers UNIT PKG.-25</p> <p style="text-align: right;">61</p>



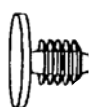



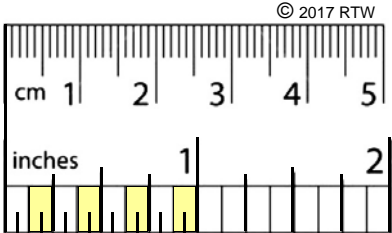

WEATHERSTRIP & PLASTIC RETAINERS ASSORTMENT

<p># Y6544 4</p>  <p>WEATHERSTRIP RETAINER LINCOLN/ FORD '89 & UP UNIT PKG.-50</p> <p>HOLE SIZE-5 MM HEAD SIZE-5 X 15 MM</p> <p style="text-align: right;">44</p>	<p style="text-align: right;">5</p>  <p style="text-align: right;">© 2017 RTW</p>	<p># Y4062 6</p>  <p>RETAINER-HOOD & OTHERS HONDA (ACURA, ODYSSEY) UNIT PKG.-25</p> <p>HOLE SIZE-6 MM HEAD DIAM.-10 MM STEM-10 MM</p> <p style="text-align: right;">404</p>
<p style="text-align: right;">10</p>	<p># Y6540 11</p>  <p>WEATHERSTRIP RETAINER GM & CHRYSLER UNIT PKG.- 50</p> <p>HOLE SIZE-5 MM HEAD DIAM.-10 MM OVERALL LENGTH-13 MM</p> <p style="text-align: right;">101</p>	<p># Y10932 12</p>  <p>RETAINER-HOOD & TRUNK MOULDING HONDA- ACURA & CIVIC-'94 & UP HOLE SIZE-6 MM HEAD DIAM.-12 MM STEM-9 MM UNIT PKG.-10</p> <p style="text-align: right;">202</p>
<p># Y12638 16</p>  <p>WEATHERSTRIP RETAINER GM & CHRYSLER NEON UNIT PKG.- 50</p> <p>HOLE SIZE-5 MM HEAD DIAM.-10 MM STEM-16 MM</p> <p style="text-align: right;">60</p>	<p># Y4620 17</p>  <p>SCREW RETAINER BLACK GM, AMC & UNIVERSAL, UNIT PKG.-100</p> <p>HOLE SIZE-1/4" HEAD DIAM.-45/64" STEM LENGTH-1/2"</p> <p style="text-align: right;">45</p>	<p># Y6550 18</p>  <p>BLACK UNIVERSAL NYLON SHIELD RETAINERS 3/16" (4.5MM) HOLE SIZE UNIT PKG.-25</p> <p style="text-align: right;">120</p>
<p style="text-align: right;">22</p>	<p># W2523 23</p>  <p>PANEL /HOOD SEAL CLIP TOYOTA UNIT PKG.-25</p> <p>HOLE SIZE-5 MM HD. DIAM.-13 MM</p> <p style="text-align: right;">GLOSS FINISH 62</p>	<p># Y8662 24</p>  <p>PANEL RETAINER TOYOTA UNIT PKG.-50</p> <p>HOLE SIZE-5 MM HD. DIAM.-13 MM</p> <p style="text-align: right;">SATIN TEXTURE 143</p>

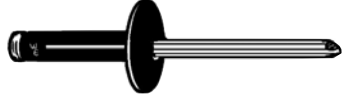
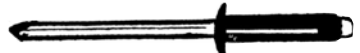

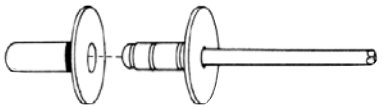







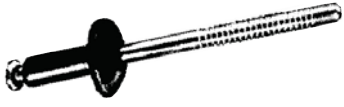

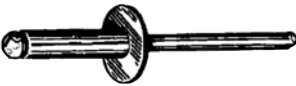
RIVETS METAL & PLASTIC ASSORTMENT

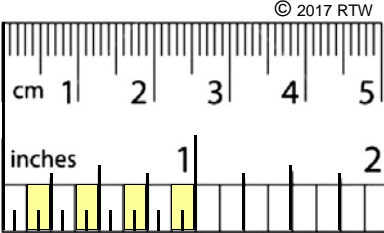
<p style="text-align: right;">1</p> 	<p style="text-align: right;">2</p> <p># Y864</p>  <p style="text-align: center;"> 3/16" ALL ALUMINUM SPECIAL SPLIT RIVET BODY PANEL & MOULDINGS 3/8" FLANGE .04-.354" GRIP RANGE GM VANS-1990 & UP BLACK UNIT PKG.-25 </p> <p style="text-align: right;">44</p>	<p style="text-align: right;">3</p> <p># Y9682</p>  <p style="text-align: center;"> 3/16" RIVET GRILLE RETAINING ALL ALUMINUM 3/8-1/2" GRIP RANGE (9/16" LARGE FLANGE) BLACK- FORD-'79 & UP UNIT PKG.-25 </p> <p style="text-align: right;">109</p>
<p># Y19520</p>  <p style="text-align: center;"> (11516807) 3/16"-BLACK- ALL ALUMINUM SPLIT TYPE- RIVET BMPR FASCIA/LICENSE PLATE BRACKET-5/8" FLANGE .047-.359" GRIP RANGE GM '90 & UP-UNIVERSAL UNIT PKG.-25 </p> <p style="text-align: right;">152</p>	<p style="text-align: right;">8</p> <p># Y6146</p>  <p style="text-align: center;"> 5/32" ALL ALUMINUM SPECIAL SPLIT RIVET-5/16" FLANGE, .04- .275" GRIP RANGE WHEEL OPENINGS, BUMPERS, ROOF RACKS BLACK UNIT PKG.-25 </p> <p style="text-align: right;">298</p>	<p style="text-align: right;">9</p>
<p># Y19674</p>  <p style="text-align: center;"> DOOR DRIP MOULDING RETAINER UNIT PKG.-10 </p> <div style="border: 1px solid gray; padding: 2px; width: fit-content; margin: 5px auto;"> <p style="font-size: small;"> DIAMETER-3.2 MM (1/8") HOLE SIZE-4 MM (5/32") FLANGE-8 MM (5/16") GRIP RANGE-1.2- 4 MM (3/64-5/32") </p> </div> <p style="text-align: right;">51</p>	<p style="text-align: right;">14</p> <p># Y19676</p>  <p style="text-align: center;"> DOOR WINDOW MOULDING RETAINER CAMRY / ES & IS UNIT PKG.-10 </p> <div style="border: 1px solid gray; padding: 2px; width: fit-content; margin: 5px auto;"> <p style="font-size: small;"> DIAMETER-3.2 MM (1/8") HOLE SIZE-4.4 MM (11/64") FLANGE-6 MM (15/64") GRIP RANGE-TO 3.4 MM (9/64") </p> </div> <p style="text-align: right;">207</p>	<p style="text-align: right;">15</p> <p># Y15940</p>  <p style="text-align: center;"> GAS FILLER DOOR/WINDSHIELD SIDE MOULDING CAMRY & SIENNA UNIT PKG.- 10 </p> <div style="border: 1px solid gray; padding: 2px; width: fit-content; margin: 5px auto;"> <p style="font-size: small;"> DIAMETER-4 MM (5/32") HOLE SIZE-5.2 MM (13/64") FLANGE-14 MM (9/16") GRIP RANGE-1-4 MM (1/32-11/64") </p> </div> <p style="text-align: right;">47</p>
<p style="text-align: right;">19</p>	<p style="text-align: right;">20</p> <p># Y133</p>  <p style="text-align: center;"> NYLON BLIND RIVET HOLE DIAM: 5 MM (3/16") PANEL RANGE- 3 MM- 6 MM (1/8-1/4") HEAD DIAM.- 12 MM (1/2") UNIT PKG.-25 </p> <p style="text-align: right;">148</p>	<p style="text-align: right;">21</p> <p># Y138</p>  <p style="text-align: center;"> NYLON BLIND RIVET HOLE DIAM: 5 MM (3/16") PANEL RANGE- 6 MM- 10 MM (1/4-3/8") HEAD DIAM.- 12 MM (1/2") UNIT PKG.-25 </p> <p style="text-align: right;">56</p>









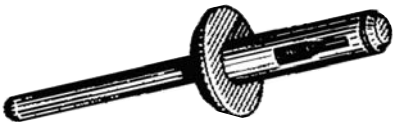
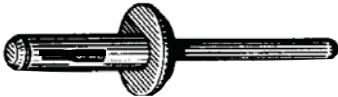

RIVETS METAL & PLASTIC ASSORTMENT

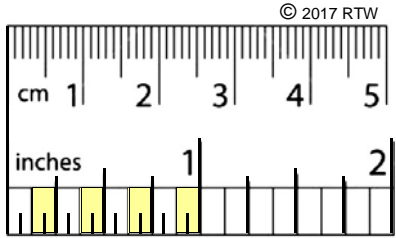
<p># Y12474 4</p>  <p>3/16" SPLIT ALUMINUM RIVET/STEEL MANDREL BLACK DOOR HANDLE/WINDOW REGULATOR 1/2" FLANGE DIAM. (.031-250" GRIP) FORD-'95 & UP UNIT PKG.-25 60</p>	<p>5</p> <p># Y593 6</p>  <p>3/16" RIVET-ALL ALUMINUM (SCUFF PLATE TO SILL) (7/16" FLANGE) .078-.236" GRIP RANGE GM, FORD-LINCOLN-'89 & UP-BLACK UNIT PKG.-25 304</p>	
<p># Y4506 10</p>  <p>5/32" ALUMINUM RIVET/ STEEL MANDREL LARGE FLANGE (15/32"DIAM.) 1/4"-3/8" GRIP RANGE WHEELHOUSE MOULDING RETAINER-BLACK VW & UNIVERSAL UNIT PKG.-25 174</p>	<p># Y20104 11</p>  <p>(003-990-94-97) Split-Type Rivet 5/32" (4mm) Diameter Grip: 3/64" - 9/32" (1mm - 7mm) Flange Diameter: 5/16" (8mm) Aluminum Rivet Aluminum Mandrel Mercedes-Benz 2004 - On 133 UNIT PACKAGE: 25</p>	<p># Y23711 12</p>  <p>SUPER SPLIT ALUM. RIVET/ STEEL MANDREL WINDOW REGULATOR RIVET 1/4" DIAM., .30-.140 GRIP RANGE .257-.261 HOLE REQUIRED GM, FORD, CHRYSLER-'76&UP UNIT PKG.-50 108</p>
<p>16</p>  <p><small>© 2017 RTW</small></p>	<p># Y7426 17</p>  <p>1/8" ALL ALUMINUM RIVET FOR WINDSHIELD SIDE RAIL 3/8" FLANGE DIAMETER .063-.125" GRIP RANGE FORD-'89 & UP BLACK UNIT PKG.-50 93</p>	<p># Y23761 18</p>  <p>SUPER-SPLIT "GLASS STOP" RIVET ALUM. RIVET/ STEEL MANDREL 1/4" DIAMETER .52-.59" GRIP RANGE .257-.261" HOLE REQUIRED FORD, CHRYSLER-'76&UP UNIT PKG.-25 91</p>
<p># Y140 22</p>  <p>NYLON BLIND RIVET HOLE DIAM: 5 MM (3/16") PANEL RANGE- 3 MM- 4 MM (1/8-5/32") HEAD DIAM.- 9 MM (23/64") UNIT PKG.-25 68</p>	<p># Y23751 23</p>  <p>(OE-388047-S102) DOOR HANDLE RIVET PEEL TYPE-1/4" DIAMETER .90-.125 GRIP RANGE ZINC & BLACK PHOS.-FORD UNIT PKG.-25 54</p>	<p># Y639 24</p>  <p>CHRYSLER-(6035201) FORD-(N806830-S100) 1/4" ALL ALUMINUM RIVET BUMPER COVER & LICENSE PLATE BRACKET 11/16" FLANGE DIAMETER .187-.375" GRIP RANGE FORD-BLACK UNIT PKG.-15 265</p>









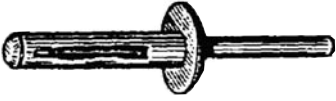
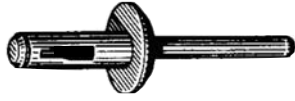
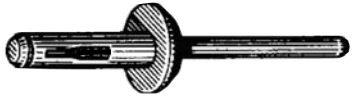
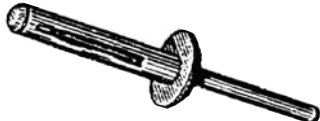

SCREWS & PLASTIC RIVETS ASSORTMENT

<p># Y143 1</p>  <p>NYLON BLIND RIVET HOLE DIAM: 7 MM (9/32") PANEL RANGE- 2.5 MM- 6 MM (3/32-15/64") HEAD DIAM.- 18 MM (45/64") UNIT PKG.-25 56</p>	<p># Y136 2</p>  <p>NYLON BLIND RIVET HOLE DIAM: 6.3MM (1/4") PANEL RANGE- 2.5 MM- 5 MM (3/32-3/16") HEAD DIAM.- 13.08 MM (1/2") UNIT PKG.-25 57</p>	<p># Y135 3</p>  <p>NYLON BLIND RIVET HOLE DIAM: 6.3 MM (1/4") PANEL RANGE- 4 MM- 10 MM (5/32-3/8") HEAD DIAM.- 13 MM (1/2") UNIT PKG.-25 159</p>
<p style="text-align: right;">7</p>	<p style="text-align: right;">8</p>	<p style="text-align: right;">9</p>  <p style="text-align: right;">© 2017 RTW</p>
<p># Y552 13</p>  <p>#14 X 3/4" SLOTTED HEX WASHER HEAD TAPPING SCREW TYPE-AB, ZINC PLATED (FOR LICENSE PLATES) USE WITH #818, 826 UNIT PKG.-100 133</p>	<p># Y694 14</p>  <p>8 x 3/4" 13/32" O.D. Washer Phillips Oval Washer Head Black Phosphate Finish Teks® Screws UNIT PKG.-50 57</p>	<p style="text-align: right;">15</p>
<p># Y022634 19</p>  <p>#10-16 X 3/4" PHILLIPS ROUND "FLAT TOP" WASHER HEAD (1/2" WASHER O.D.) SHEET METAL SCREWS-AB 500 HOUR SALT SPRAY TOLERANCE BLACK EACH UNIT PKG.-50 59</p>	<p># Y022343 20</p>  <p>#8-15 X 3/4" (13/32" WASHER) PHILLIPS FLAT TOP WASHER HEAD SELF-PIERCING SCREW BLACK UNIT PKG.-100 45</p>	<p># Y743 21</p>  <p>(FORD-56912-S2) #8-18 X 3/4" (1/2" WASHER O.D.) ROUND WASHER HEAD SHEET METAL SCREWS- AB-BLACK UNIT PKG.-100 129</p>













SCREWS & PLASTIC RIVETS ASSORTMENT

<p># Y144 4</p>  <p>NYLON BLIND RIVET HOLE DIAM: 6.3MM (1/4") PANEL RANGE- 8 MM- 12 MM (5/16-1/2") HEAD DIAM.- 16.8 MM (21/32") UNIT PKG.-25 96</p>	<p># Y477 5</p>  <p>NYLON BLIND RIVET HOLE DIAM: 6.3 MM (1/4") PANEL RANGE- 2.5 MM- 5 MM (3/32-3/16") HEAD DIAM.- 18 MM (45/64") UNIT PKG.-25 89</p>	<p># Y476 6</p>  <p>NYLON BLIND RIVET HOLE DIAM: 6.3 MM (1/4") PANEL RANGE- 4 MM- 10 MM (5/32-3/8") HEAD DIAM.- 17 MM (11/16") UNIT PKG.-25 212</p>
<p># Y139 10</p>  <p>NYLON BLIND RIVET HOLE DIAM: 6 MM (1/4") PANEL RANGE- 4 MM- 8.5 MM (5/32-21/64") HEAD DIAM.- 13 MM (1/2") UNIT PKG.-25 90</p>	<p># Y12422 11</p>  <p>6.3-1.81 X 16 MM (#14 X 5/8") PHILLIPS WASHER HEAD SHEET METAL SCREW-AB (15.5MM WASHER DIAM.) JAPANESE CARS & UNIVERSAL- BLACK UNIT PKG.-50 134</p>	<p># Y11170 12</p>  <p>4.8-1.59X15 MM (#10 X 5/8") PHILLIPS WASHER HEAD SHEET METAL SCREW-AB (14 MM WASHER DIAMETER) NISSAN BUMPER & UNIVERSAL BLACK UNIT PKG.-50 210</p>
<p># Y491 17</p>  <p>#8 X 1/2" PHILLIPS FLAT WASHER HEAD SCREW-SELF DRILLING (4.2MM X 13MM) (7/16" WASHER O.D.) ZINC/BLACK UNIT PKG.-50 129</p>	<p># Y15978 18</p>  <p>5 MM X 16 MM PHILLIPS TRUSS HEAD SCREW- 16 MM LOOSE WASHER BLACK/ ZINC JAPANESE CARS/ UNIVERSAL UNIT PKG.-25 397</p>	
<p># Y022313 22</p>  <p>#8 X 1/2" PHILLIPS FLAT TOP-ROUND WASHER HD SCREW- (3/8" WASHER O.D.)-AB UNIT PKG.-100 63</p>	<p># Y497 23</p>  <p>#8 X 1/2" (3/8" WASHER DIAMETER) PHILLIPS OVAL WASHER HEAD SELF DRILLING SCREW- PLATED WHEEL OPENING MOULDING SCREW UNIT PKG.-50 86</p>	<p># Y6313 24</p>  <p>UNSLOTTED HEX WASHER HEAD #8 X 1/2" UNIT PKG.-100 174</p>

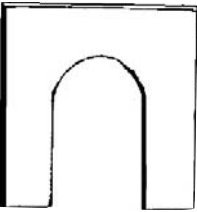
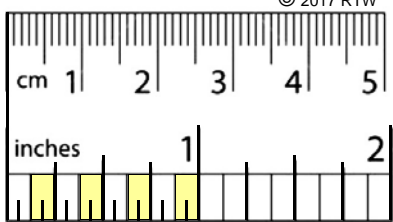

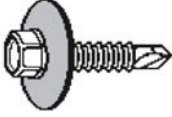





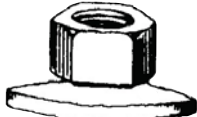

NUTS, SHIMS & WASHER SCREWS ASSORTMENT

<p># Y18356 1</p>  <p style="text-align: center;">Pac-Man Shims 1/8" Thickness 15/16" I.D., 3/8" Slot UNIT PKG. -50</p> <p style="text-align: right;">50</p>	<p># Y106 2</p>  <p style="text-align: center;">1/4" FLAT WASHER UNIT PKG.-100</p> <p style="text-align: right;">44</p>	<p># Y591 3</p>  <p style="text-align: center;">"U" TYPE CLIP NUT LONG THROAT, WIDE RANGE #8A OR 4.2 MM SCREW SIZE PANEL RANGE-.025-.150 GM, FORD & UNIVERSAL UNIT PKG.-100</p> <p style="text-align: right;">96</p>
<p># Y18354 7</p>  <p style="text-align: center;">Pac-Man Shims 1/16" Thickness 15/16" I.D., 3/8" Slot UNIT PKG. -50</p> <p style="text-align: right;">50</p>	<p># Y107 8</p>  <p style="text-align: center;">5/16" FLAT WASHER UNIT PKG.-100</p> <p style="text-align: right;">42</p>	<p># Y1176 9</p>  <p style="text-align: center;">"U" TYPE CLIP NUT #10A SCREW SIZE GENERAL PURPOSE WIDE PANEL RANGE PANEL RANGE- .025-.150 UNIVERSAL UNIT PKG.-25</p> <p style="text-align: right;">97</p>
<p># YN116 SHIM - ZINC 13</p>  <p style="text-align: center;">1-1/8 x 1-1/8 w/1/2 Slot THICKNESS 1/16" UNIT PKG.-50</p> <p style="text-align: right;">45</p>	<p style="text-align: right;">14</p>  <p style="text-align: center;">© 2017 RTW</p>	<p># Y6982 15</p>  <p style="text-align: center;">"U" TYPE CLIP NUT #8 SCREW SIZE GENERAL PURPOSE PANEL RANGE- .025-.150 UNIT PKG.-100</p> <p style="text-align: right;">87</p>
<p># Y9696 19</p>  <p style="text-align: center;">4.2 - 1.41 x 20 mm 7 mm Indented Hex Head 17 mm O.D. Loose Washer Black Phosphate Finish Teks® Screws UNIT PKG.-100</p> <p style="text-align: right;">71</p>	<p># Y589 20</p>  <p style="text-align: center;">4.2 - 1.41 x 20 mm 7 mm Indented Hex Head 12 mm O.D. Loose Washer Black Phosphate Finish Teks® Screws UNIT PKG.-50</p> <p style="text-align: right;">72</p>	<p style="text-align: right;">21</p>

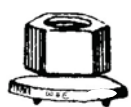
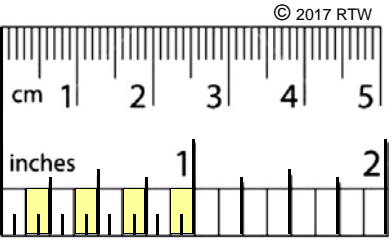
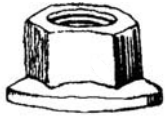

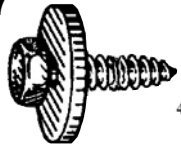



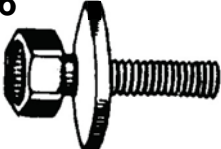

NUTS, SHIMS & WASHER SCREWS ASSORTMENT

<p># Y2880 4</p> <div style="text-align: center;">  </div> <p style="text-align: center;">5 MM NUT WITH FREE SPINNING 15 MM WASHER 10 MM HEX, PHOS & OIL GM, FORD & UNIVERSAL UNIT PKG.-50</p> <p style="text-align: right;">45</p>	<p># Y335 5</p> <div style="text-align: center;">  </div> <p style="text-align: center;">8 MM NUT WITH FREE SPINNING 24 MM WASHER, 13 MM HEX PHOS & OIL GM- '77 & UP UNIT PKG.-25</p> <p style="text-align: right;">61</p>	<p># Y9546 6</p> <div style="text-align: center;">  </div> <p style="text-align: center;">6 MM NUT WITH FREE SPINNING 19MM WASHER 10 MM HEX, PHOS & OIL GM & CHRYSLER UNIT PKG.-50</p> <p style="text-align: right;">275</p>
<p># Y14854 10</p> <div style="text-align: center;">  </div> <p style="text-align: center;">5 MM HEX FLANGE NUT (8 MM HEX)(11.5 MM FLANGE) GM & UNIVERSAL UNIT PKG.-50</p> <p style="text-align: right;">93</p>	<p># Y8736 11</p> <div style="text-align: center;">  </div> <p style="text-align: center;">8 MM HEX FLANGE NUT (13 MM HEX) (17 MM FLANGE) CHRYSLER, GM AND UNIVERSAL UNIT PKG.-100</p> <p style="text-align: right;">54</p>	<p># Y603 12</p> <div style="text-align: center;">  </div> <p style="text-align: center;">6 MM NUT WITH FREE SPINNING 16 MM TOOTHED WASHER 10 MM HEX, PHOS & OIL VW, GM-'79 & UP UNIT PKG.-25</p> <p style="text-align: right;">144</p>
<p style="text-align: right;">16</p> <div style="text-align: center;">  <p style="font-size: small;">© 2017 RTW</p> </div>	<p># Y696 17</p> <div style="text-align: center;">  </div> <p style="text-align: center;">10 MM HEX FLANGE NUT (15 MM HEX) (21 MM FLANGE) GM & UNIVERSAL UNIT PKG.-25</p> <p style="text-align: right;">77</p>	<p># Y9604 18</p> <div style="text-align: center;">  </div> <p style="text-align: center;">6 MM HEX FLANGE NUT (10 MM HEX) (13.5 MM FLANGE) UNIT PKG.-50</p> <p style="text-align: right;">83</p>
<p># W3117 22</p> <div style="text-align: center;">  </div> <p style="text-align: center;">4.8-1.59 X 16 MM (#10 X 5/8")</p> <p style="text-align: center;">HEX HEAD SHEET METAL SCREW-AB WITH 19 MM LOOSE WASHER 8 MM HEX FORD & UNIVERSAL UNIT PKG.- 50 ZINC/BLACK</p> <p style="text-align: right;">152</p>	<p># Y486 23</p> <div style="text-align: center;">  </div> <p style="text-align: center;">4.2-1.41X 20MM (#8X3/4") UNSLOTTED HEX HD SCREW (7MM HEX;12 MM LOOSE WASHER) GM- "J" & "X" BODIES BLACK UNIT PKG.-100</p> <p style="text-align: right;">93</p>	<p># Y481 24</p> <div style="text-align: center;">  </div> <p style="text-align: center;">4.2-1.41x20MM UNSLOTTED-INDENTED HEX HD SCREW WITH LOOSE WASHER (16MM WSHR, 7MM HEX) PANEL TO FRAME, ALSO GRILLE GM AND UNIVERSAL UNIT PKG.-50</p> <p style="text-align: right;">387</p>

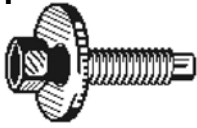

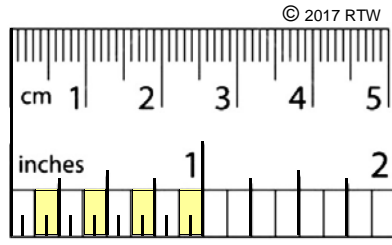
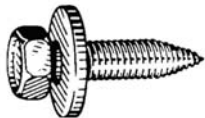
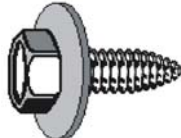

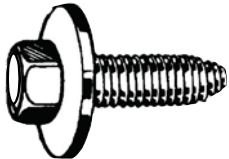
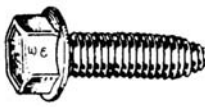
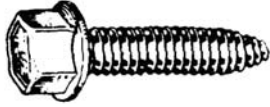

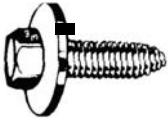

BODY BOLTS & FOLDOVER NUTS ASSORTMENT

<p># Y7506 1</p>  <p>6 X 20 MM BODY BOLT INDENTED HEX HEAD 20 MM WASHER 10 MM HEX- BLACK GM & UNIVERSAL UNIT PKG.-50</p> <p style="text-align: right;">112</p>	<p># Y602 2</p>  <p>6 X 22 MM BODY BOLT INDENTED HEX HEAD 8 MM HEX; 19 MM (3/4") WASHER DOG POINT FORD, CHRYSLER & UNIVERSAL UNIT PKG.-25</p> <p style="text-align: right;">82</p>	<p># Y2894 3</p>  <p>6 - 1.00 x 28 mm Black Phos. Dog Point Metric Body Bolts UNIT PKG.-50</p> <p style="text-align: right;">65</p>
<p># Y488 7</p>  <p>(11503800) 6 MM X 20 MM HEX WASHER HEAD BODY BOLT- CA PT. (10 MM HEX, 13 MM WASHER) GM & UNIVERSAL '77 & UP UNIT PKG.-50</p> <p style="text-align: right;">96</p>	<p># 8</p>  <p style="text-align: right;">96</p>	<p># Y489 9</p>  <p>6 MM X 25 MM BODY BOLT INDENTED HEX HEAD (17 MM LOOSE WASHER; 10MM HEX) CA POINT (SMALLER WASHER THAN Y-490 GM, HONDA, NISSAN & TOYOTA UNIT PKG.-50</p> <p style="text-align: right;">463</p>
<p># 13</p>	<p># Y482 14</p>  <p>8 - 1.25 x 25 mm Black Phos. CA Point Metric Body Bolts UNIT PKG.-25</p> <p style="text-align: right;">103</p>	<p># Y483 15</p>  <p>8 MM X 30 MM BODY BOLT INDENTED HEX HEAD WITH 24 MM LOOSE WASHER CA POINT GM-'77 & UP AND UNIVERSAL UNIT PKG.-25</p> <p style="text-align: right;">179</p>
<p># Y701 19</p>  <p>10 MM X 40 MM BODY BOLT INDENTED HEX HEAD WITH 28 MM LOOSE WASHER CA POINT GM-'77 & UP AND UNIVERSAL UNIT PKG.-25</p> <p style="text-align: right;">60</p>	<p># Y2910 20</p>  <p>8 MM x 25 MM BODY BOLT HEX WASHER HEAD; CA POINT (13 MM HEX; 16MM WASHER O.D.) GM & UNIVERSAL- '77 & UP UNIT PKG.-25</p> <p style="text-align: right;">113</p>	<p># Y493 21</p>  <p>8-1.25 X 30MM HEX WASHER HEAD BODY BOLT- CA POINT (13MM HEX; 17MM WASHER) BLACK UNIT PKG.-25</p> <p style="text-align: right;">44</p>

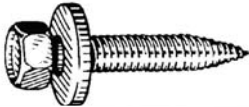

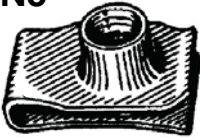
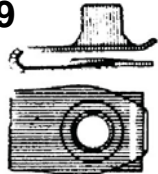
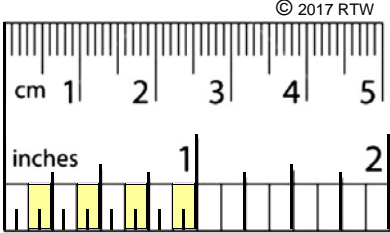
BODY BOLTS & FOLDOVER NUTS ASSORTMENT









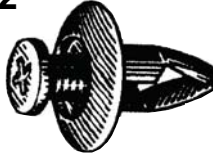
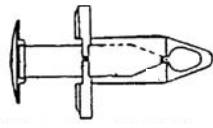

<p># Y490 4</p>  <p>6 MM X 25 MM BODY BOLT INDENTED HEX HEAD WITH 24 MM LOOSE WASHER CA POINT GM & UNIVERSAL UNIT PKG.-50</p> <p style="text-align: right;">261</p>	<p># Y8830 5</p>  <p>6.3 X 25 MM HEX HEAD SCREW WITH 17MM LOOSE WASHER (10 MM HEX) GM PRODUCTS-BLACK UNIT PKG.-50</p> <p style="text-align: right;">104</p>	<p># Y501 6</p>  <p>6.3 X 20MM HEX WASHER HEAD SCREW WITH 17MM LOOSE WASHER (10MM HEX) GM PRODUCTS. UNIT PKG.-50</p> <p style="text-align: right;">432</p>
<p style="text-align: right;">10</p>	<p># Y8938 11</p>  <p>6 X 35 MM BODY BOLT INDENTED HEX HEAD (17 MM WASHER;10MM HEX) CA POINT GM & UNIVERSAL UNIT PKG.-50</p> <p style="text-align: right;">201</p>	<p># Y692 12</p>  <p>6 MM X 20 MM BODY BOLT INDENTED HEX HEAD (17 MM LOOSE WASHER;10MM HEX) CA POINT GM-'82 & UP AND UNIVERSAL UNIT PKG.-25</p> <p style="text-align: right;">494</p>
<p># Y9006 16</p>  <p>8 MM X 35 MM BODY BOLT INDENTED HEX HEAD WITH 24 MM LOOSE WASHER, CA POINT-BLACK GM AND UNIVERSAL UNIT PKG.-25</p> <p style="text-align: right;">54</p>	<p># YMUN5 17</p>  <p>8 MM METRIC FOLDOVER NUT GM, FORD & UNIVERSAL UNIT PKG.-25</p> <p style="text-align: right;">45</p>	<p># YMUN9 18</p>  <p>6 MM METRIC SPEED NUT GM- '79 & UP FORD & UNIVERSAL UNIT PKG.-25</p> <p style="text-align: right;">451</p>
<p style="text-align: right;">22</p>  <p style="text-align: right;">© 2017 RTW</p>	<p># YMUN6 23</p>  <p>8 MM LONG THROAT METRIC FOLDOVER NUT GM- '77 & UP, UNIVERSAL UNIT PKG.-25</p> <p style="text-align: right;">59</p>	<p># Y8738 24</p>  <p>6 MM METRIC SPEED NUT LONG THROAT GM- "X" & "J" CARS & UNIVERSAL UNIT PKG.-50</p> <p style="text-align: right;">288</p>



HOT BOX

DISCOUNT BULK PACK

AVAILABLE IN BULK PACKAGES







<p># YB01 1</p>  <p># Y4520</p> <p>BULK QTY - 250</p>	<p># YB02 2</p>  <p># Y473</p> <p>BULK QTY - 100</p>	<p># YB03 3</p>  <p># Y5114</p> <p>BULK QTY - 150</p>
<p># YB07 7</p>  <p># Y12766</p> <p>BULK QTY - 100</p>	<p># YB08 8</p>  <p># Y12264</p> <p>BULK QTY - 50</p>	<p># YB09 9</p>  <p># Y11904</p> <p>BULK QTY - 100</p>
<p># YB13 13</p>  <p># Y19676</p> <p>BULK QTY - 50</p>	<p># YB14 14</p>  <p># Y6146</p> <p>BULK QTY - 100</p>	<p># YB15 15</p>  <p># Y593</p> <p>BULK QTY - 100</p>
<p># YB19 19</p>  <p># Y4282</p> <p>BULK QTY - 50</p>	<p># YB20 20</p>  <p># Y552</p> <p>BULK QTY - 250</p>	<p># YB21 21</p>  <p># Y501</p> <p>BULK QTY - 150</p>

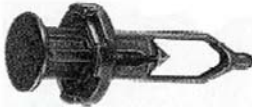
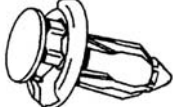
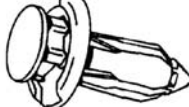

HOT BOX

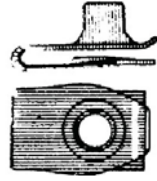
DISCOUNT BULK PACK

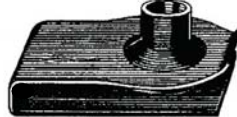
AVAILABLE IN BULK PACKAGES

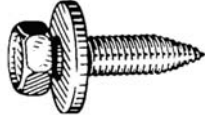
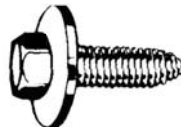
<p># YB04 4</p>  <p># Y8698 BULK QTY - 25</p>	<p># YB05 5</p>  <p># Y11644 BULK QTY - 50</p>	<p># YB06 6</p>  <p># Y13776 BULK QTY - 50</p>
<p># YB10 10</p>  <p># Y14024 BULK QTY - 100</p>	<p># YB11 11</p>  <p># Y3174 BULK QTY - 100</p>	<p># YB12 12</p>  <p># YMUN9 BULK QTY - 150</p>
<p># YB16 16</p>  <p># Y476 BULK QTY - 150</p>	<p># YB17 17</p>  <p># Y9546 BULK QTY - 150</p>	<p># YB18 18</p>  <p># Y8738 BULK QTY - 150</p>
<p># YB22 22</p>  <p># Y692 BULK QTY - 150</p>	<p># YB23 23</p>  <p># Y489 BULK QTY - 150</p>	<p># YB24 24</p>  <p># Y490 BULK QTY - 150</p>



PLASTIC NAILS & PUSH IN RETAINERS

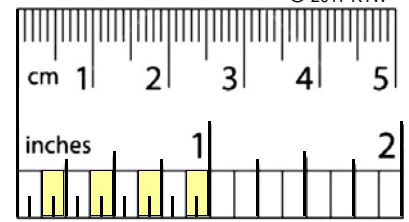

Y465



DOOR PANEL CLIP BUMPER STRIP
GM-'80 & UP,
UNIT PKG.-25
HOLE SIZE-10MM; HEAD SIZE-22MM
OVERALL HEIGHT-24MM

Y4670



TRIM PANEL
RETAINER
FORD-1980 & UP

Y9548



PANEL FASTNER
FASCIA & GENERAL USE
CHRYSLER-'84 & UP,
UNIT PKG.-50
(FOR 1/4" HOLE)

Y121

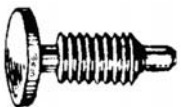

RETAINER-FLEXIBLE FILLER BETWEEN
IMPACT BUMPER & FENDER
GM & UNIVERSAL,
UNIT PKG.-50
HOLE SIZE-1/4"; HEAD DIAM.-1/2"
OVERALL HEIGHT—13/16"

Y461



GRILLE RETAINER
GM-"N" BODY - 85 & UP
UNIT PKG.-50
HOLE SIZE-1/8" HEAD DIAM.-15/64"
OVERALL HEIGHT-51/64"

Y12412



BLACK UNIVERSAL
NYLON SHIELD RETAINERS
HOLE SIZE-7/32" (5.5MM)
UNIT PKG.-25

Y11080

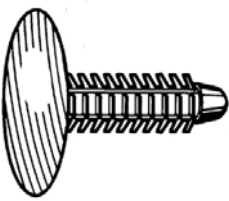

NYLON SHIELD RETAINERS
BLACK UNIVERSAL
HOLE SIZE-1/4" (6.4MM)
UNIT PKG.-25

Y6926

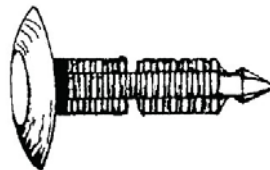

INTERIOR TRIM RETAINER
GM & UNIVERSAL,
UNIT PKG.-25
HOLE SIZE 7MM, HEAD O.D.-19MM
OVERALL LENGTH-34.5MM

Y12656



HOOD INSULATION CLIP
GM, CHRYSLER, FORD-'96 & UP,
UNIT PKG.-50
HOLE SIZE-1/4", HEAD DIAM.-1-1/4"
OVERALL HEIGHT-25/32"

Y9066



HOOD INSULATION CLIP
TOYOTA-
AVALON, CAMRY, LEXUS-'88 & UP
UNIT PKG.-15

HOLE SIZE-6 MM
HEAD DIAM.-30 MM
OVERALL LENGTH-20 MM

Y3116

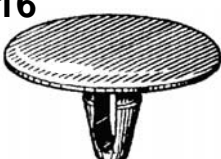

HOOD INSULATION CLIP
TOYOTA
UNIT PKG.-25

HOLE SIZE- 7 MM
HEAD DIAM.-30 MM

Y17180









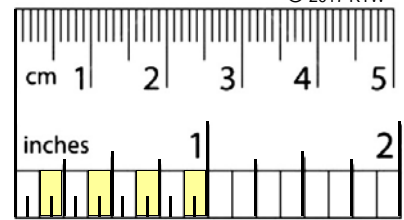

DOOR PANEL RETAINER-
FRONT AND REAR,
GEO PRISM; TOYOTA-CELICA,
COROLLA, PREVIA & LEXUS
UNIT PKG.-25

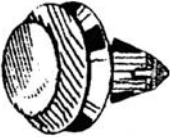
HOLE SIZE-9 MM

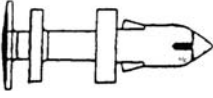

PLASTIC NAILS & PUSH IN RETAINERS

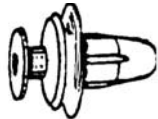
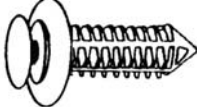
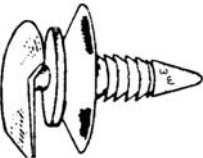







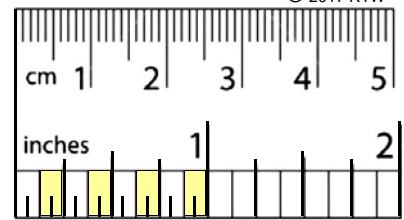

<p># Y18390</p>  <p>DOOR TRIM PANEL RETAINER CHRYSLER VANS- '98 & UP UNIT PKG.-25</p> <p>HOLE SIZE-9 MM OVERALL LENGTH-21 MM</p>	<p># Y470</p>  <p>TRIM PANEL CLIP FORD-ALL MODELS-'80 & UP UNIT PKG.-25</p>	<p># Y580</p>  <p>DOOR PANEL FASTENER PLASTIC, GM- '83 & UP UNIT PKG.-25</p>
<p># Y11098</p>  <p>HOOD INSULATION RETAINER CHRYSLER- LH & NS MINIVANS GM-SATURN UNIT PKG.-50</p> <p>HOLE SIZE- 1/4" HEAD DIAM.-1-3/16"</p>	<p># Y11260</p>  <p>HOOD INSULATION CLIP- HONDA- ACCORD-'91 & UP HEAD DIAM.-30 MM OVERALL LENGTH -12 MM</p>	<p># Y185</p>  <p>DOOR PANEL RETAINER PUSH RIVET GM TRUCKS- '95 & UP UNIT PKG.-50</p> <p>HOLE SIZE-7 MM TOP HD. DIAM.-16 MM OVERALL LENGTH-35 MM</p>
<p># Y10394</p>  <p>(SUB FOR 6504452-MINIVANS) TRIM PANEL RETAINER JEEP&DODGE TRUCKS- '93 & UP UNIT PKG.-50</p> <p>HOLE SIZE-7 MM STEM LENGTH-15 MM</p>	<p># Y3084</p>  <p>DOOR PANEL FASTENER TOYOTA, MAZDA, ISUZU GM-NOVA-'85 UNIT PKG.-25</p>	<p># Y7842</p>  <p>(GM-10143422) (CHRYSLER- 34202599) (AMC- 893202-599) DOOR PANEL FASTENER FORD, GM, CHRYSLER JEEP EAGLE, PREMIER -'88&UP UNIT PKG.-50</p>
<p># Y458</p>  <p>DOOR TRIM TO INNER PANEL FASTENER GM - '77 TO '82 UNIT PKG.-50</p>	<p># Y592</p>  <p>HOOD INSULATION/ FENDER SHIELD RETAINER CHRYSLER-'85 &UP UNIT PKG.-25</p>	<p># Y453</p>  <p>HOOD INSULATION CLIP GM AND UNIVERSAL UNIT PKG.-25</p> <p>HOLE SIZE-1/4"; HEAD DIAM.-2"; STEM-3/4"</p>

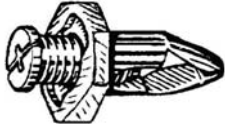

PLASTIC NAILS & PUSH IN RETAINERS

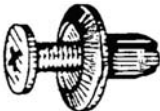

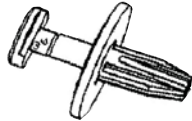
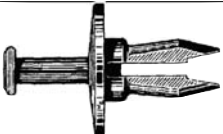
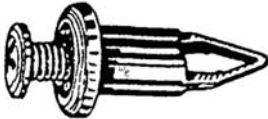
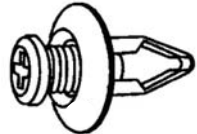





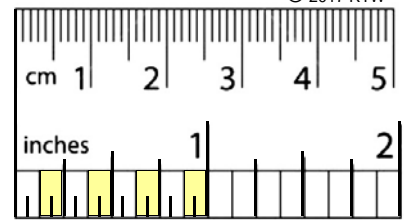

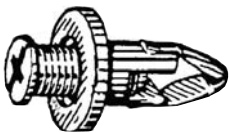
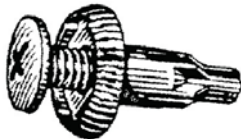

<p># Y173</p>  <p>PUSH TYPE RIVET FORD-TAURUS/SABLE; GM UNIT PKG.-25</p> <p>HOLE SIZE-8 MM FLANGE DIAM.-25 MM</p>	<p># Y494</p>  <p>PLASTIC FASCIA RETAINER NO SHOULDER, GM & CHRYSLER UNIT PKG.-25</p> <p>HOLE SIZE-8MM; HD. DIAM.-25 MM PANEL RANGE-UP TO 6.3 MM</p>	<p># Y479</p>  <p>SCREW RIVET- BUMPER FASCIA OCTAGONAL HEAD HONDA '90 & UP UNIT PKG.-10</p> <p>HOLE SIZE-10 MM</p>
<p># Y177</p>  <p>PLASTIC SCREW RIVET/ COWL VENT HONDA UNIT PKG.-25</p> <p>HOLE SIZE-6 MM:FLANGE-18 MM PANEL RANGE-2-6 MM</p>	<p># Y472</p>  <p>NYLON SCREW RIVET HONDA, NISSAN, MAZDA UNIT PKG.-25</p> <p>HOLE SIZE-8 MM: HEAD DIAM.-20 MM</p>	<p># Y4142</p>  <p>SCREW RIVET BUMPER STRIP RETAINER ACURA-'91 & UP UNIT PKG.-15</p> <p>HOLE SIZE-10MM:HD. DIAM.-20 MM STEM LENGTH- 15 MM</p>
<p># Y2742</p>  <p>PLASTIC SCREW RIVET NISSAN, HONDA, ISUZU UNIT PKG.-25</p> <p>HOLE SIZE-6 MM: HD. DIAM.-15 MM</p>	<p># Y4138</p>  <p>(91502-SPO-003) PLASTIC SCREW RIVET FRONT AND REAR BUMPER HONDA-'90 & UP HOLE SIZE-10 MM; HD. DIAM.-20 MM UNIT PKG.-10</p>	<p># Y7616</p>  <p>PLASTIC RIVET-MUD SKIRT ATTACHING, OTHER USES GM, FORD, CHRYSLER '81& UP UNIT PKG.-50</p> <p>HOLE SIZE-6 MM; HD. DIAM.-7.5MM</p>
<p># Y498</p>  <p>PLASTIC RIVET FRONT & REAR BUMPER ATTACHING STRIP GM-'81 & UP UNIT PKG.-25</p> <p>FLANGE DIAM.-1", SHOULDER -1/8"</p>	<p># Y3278</p>  <p>RETAINER- BUMPER COVER TOYOTA (LEXUS) UNIT PKG.-10</p> <p>HOLE SIZE-9 MM: HD. DIAM.-15 MM STEM- 27 MM</p>	<p># Y17712</p>  <p>PLASTIC SCREW RIVET BUMPER COVER RETAINER FORD ESCAPE-2001 & UP UNIT PKG.-25</p> <p>HOLE SIZE-8 MM; HD. DIAM.-16 MM; STEM-18 MM</p>



PLASTIC PUSH RIVETS GRILLE NUT & GROMMET WEATHERSTRIP RETAINERS

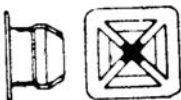







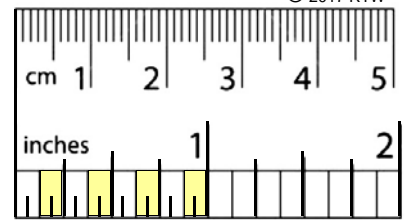



<p># Y478</p>  <p>SCREW RIVET- BUMPER FASCIA HONDA '90 & UP UNIT PKG.-10</p> <p>HOLE SIZE-10 MM HD. DIAM.-20 MM;STEM- 27 MM</p>	<p># Y4136</p>  <p>HOLE SIZE-8 MM: HD.DIAM.-18 MM</p>	<p># Y5084</p>  <p>DRIVE RIVET-BUMPER FASCIA GENERAL USE (GM, FORD, CHRYSLER) UNIT PKG.-25</p> <p>HOLE SIZE-7 MM HD. DIAM.-25 MM</p>
<p># Y5066</p>  <p>PLASTIC DRIVE RIVET GM, FORD, CHRYSLER UNIT PKG.-25</p> <p>HOLE SIZE-8 MM HD. DIAM.-17 MM</p>	<p># Y6536</p>  <p>WEATHERSTRIP RETAINER PLASTIC NAIL FASTENER GM, FORD & UNIVERSAL UNIT PKG.-100</p> <p>HOLE SIZE-3/16"</p>	<p># Y485</p>  <p>WEATHERSTRIP & TRIM PANEL CLIP NISSAN, TOYOTA, HONDA UNIT PKG.-25</p> <p>HOLE SIZE-5 MM HEAD DIAM.-13 MM OVERALL HT.-17 MM</p>
<p># Y4804</p>  <p>WEATHERSTRIP RETAINER PANEL RETAINER- GM/FORD/AMC UNIT PKG.-50</p> <p>HOLE SIZE-11/64" HEAD DIAM.-7/16" OVERALL HT.-23/32"</p>	<p># Y4354</p>  <p>PLASTIC NUT- SIDE,MARKER LAMP (9.5mm SQ.HD;#6 SCREW 8mm O/A HT.;FOR 6.4MM HOLE) TOYOTA, NISSAN, HONDA, MAZDA, MITSUBISHI AND UNIVERSAL UNIT PKG.-50</p>	<p># Y2792</p>  <p>PLASTIC SCREW NUT HEADLAMP BEZEL GM UNIT PKG.-100</p>
<p># Y454</p>  <p>HEADLAMP DOOR NUT SIDE MIRROR TO DOOR GRILLE NUT (1/4" HOLE) (USE #8-10 SCREWS) UNIT PKG.-50</p>	<p># Y933</p>  <p>GRILLE SCREW NUT (.325 HOLE) (USE #8-10 SCREWS) CHEVY, BUICK & UNIVERSAL UNIT PKG.-50</p>	<p># Y3168</p>  <p>PLASTIC GROMMET NUT SCREW ANCHOR TOYOTA, NISSAN MITSUBISHI UNIT PKG.-25</p>



GRILL NUT & GROMMET PLASTIC & METAL RIVETS, NUTS



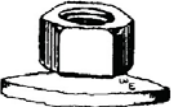





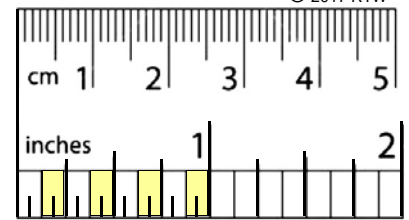

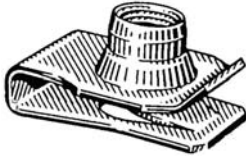

<p># Y6539</p>  <p>3/16" (4.5mm) Hole Size Black Universal Weatherstrip Retainers UNIT PKG.-25</p>	<p># Y3132</p>  <p>HEADLAMP ADJUSTING NUT 12mm SQ.HD;#8-10 SCREW FOR 9mm HOLE TOYOTA & MITSUBISHI- UNIT PKG.-50</p>	<p># Y3164</p>  <p>PLASTIC SCREW GROMMET HONDA, TOYOTA NISSAN, MAZDA UNIT PKG.-25</p>
<p># Y3353</p>  <p>5/32" ALUMINUM RIVET/ STEEL MANDREL COUNTERSUNK HEAD TRUNK LOCK-SEALED END SWIVEL EMBLEM UNIT PKG.-50</p>	<p># Y8650</p>  <p>DOOR HANDLE & LOCK RIVET 1/4" DIAM.' 3/4" HEAD .03-.14" GRIP RANGE ALUM. RIVET/ STEEL MANDREL FORD-'84 & UP, BLACK UNIT PKG.-25</p>	<p># Y4364</p>  <p>NYLON SCREW GROMMET-MAZDA NISSAN, HONDA, MIT., TOYOTA UNIT PKG.-50</p>
<p># Y132</p>  <p>13/64" (5mm) Hole Size Panel Range: 1/16" - 11/64" Flange Size: 15/32" Black Nylon Blind Rivets UNIT PKG.-25</p>	<p># Y2652</p>  <p>1/4" RIVET BUMPER ASSEMBLY ALUMINUM/ STEEL .125-.250" GRIP RANGE BLACK PHOSPHATE FORD-'81 & UP UNIT PKG.-25</p>	<p># Y3114</p>  <p>BLACK NYLON "U" NUT FENDER, WHEELHOUSE TOYOTA UNIT PKG.-15</p>
<p># Y1151</p>  <p>THREAD CUTTING NUT 3/16" STUD (9/16" FLANGE) UNIT PKG.-100</p>	<p># Y7006</p>  <p>1/4" STUD; 7/16" HEX 11/16" WASHER O.D. ZINC PLATED UNIT PKG.-200</p>	<p># Y9134</p>  <p>6 MM NUT WITH FREE SPINNING 24 MM WASHER 11 MM HEX ZINC & BLACK FORD PRODUCTS UNIT PKG.-25</p>







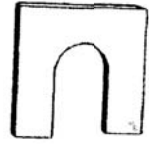



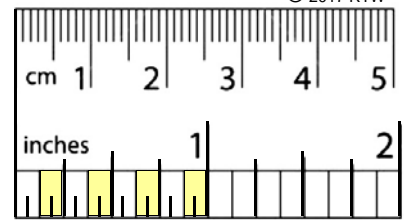

SCREWS & SHIMS

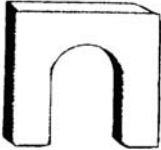

<p># YMUN7</p>  <p>10 MM METRIC SPEED NUT GM- '77 & UP, UNIVERSAL UNIT PKG.-25</p>	<p># Y001344</p>  <p>#8 X 3/4" - #6 HEAD UNIT PKG.-100</p>	<p># Y001354</p>  <p>8 x 1" #6 Head Phil. Oval Head Chrome Sheet Metal Screws UNIT PKG.-100</p>
<p># Y741</p>  <p>PHILLIPS FLAT WASHER HEAD SCREW 4.2MM X 20MM-POZIDRIVE (7/16"WASHER) GM & UNIVERSAL-BLACK UNIT PKG.-100</p>	<p># Y012343</p>  <p>8 x 3/4" Phil. Pan Head Black Sheet Metal Screws UNIT PKG.-100</p>	<p># Y12924</p>  <p>#8 X 3/8" (#6 HEAD) (3/8" WASHER DIAMETER) PHILLIPS OVAL WASHER HEAD SELF TAPPING SCREW- PLATED WHEEL OPENING MOULDING SCREW UNIT PKG.-100</p>
<p># Y554</p>  <p>LICENSE PLATE SCREW 1/4"-14 X 5/8" SLOTTED HEX WASHER HEAD-5/16" HEX 5/8" WASHER DIAM.- BLACK FORD PRODUCTS UNIT PKG.-100</p>	<p># Y022644</p>  <p>#10-16 X 1" PHILLIPS ROUND "FLAT TOP" WASHER HEAD (1/2" WASHER O.D.) SHEET METAL SCREWS-AB 500 HOUR SALT SPRAY TOLERANCE BLACK EACH UNIT PKG.-50</p>	<p># Y2832</p>  <p>Push Nut Blot Retainers Bolt Size-10MM, O.D.-24MM Unit Pkg.-100</p>
<p># Y2822</p>  <p>Push Nut Bolt Retainers Bolt Size-6MM, O.D.-17MM Unit Pkg.—100</p>	<p># Y672</p>  <p>1-1/4" X 1-1/8" 1/8" THICK- 3/8" SLOT UNIT PKG.-100</p>	<p># Y674</p>  <p>1-1/4" X 1-1/8" 1/16" THICK- 3/8" SLOT UNIT PKG.-100</p>

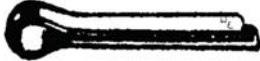
WASHERS & RIVETS



<p># Y107</p>  <p>5/16" FLAT WASHER UNIT PKG.-100</p>	<p># Y108</p>  <p>3/8" FLAT WASHER UNIT PKG.-100</p>	<p># Y156</p>  <p>SAE FLAT WASHERS - ZINC</p> <table border="0"> <tr> <td></td> <td style="text-align: right;">Unit</td> </tr> <tr> <td style="text-align: right;">Size</td> <td style="text-align: right;">Pkg.</td> </tr> <tr> <td style="text-align: right;">1/4"</td> <td style="text-align: right;">100</td> </tr> </table>		Unit	Size	Pkg.	1/4"	100
	Unit							
Size	Pkg.							
1/4"	100							
<p># YN18</p>  <p>1-1/8" X 1-1/4" 1/8" THICK- 1/2" SLOT UNIT PKG.-50</p>	<p># Y109</p>  <p>7/16" FLAT WASHER UNIT PKG.-100</p>	<p># Y110</p>  <p>1/2" FLAT WASHER UNIT PKG.-100</p>						
<p># Y135415</p>  <p>1/8" X 1-1/2" Unit Pkg.- 100</p>	<p># Y01171</p>  <p>Standard Dome Blind Rivets Steel Rivet/Steel Mandrel Rivet Diam.-1/8" Pnl Thickness-1/8 to 1/4" Unit Pkg.- 100</p>	<p># Y01211</p>  <p>Standard Dome Blind Rivets Steel Rivet/Steel Mandrel Rivet Diam.-1/8" Pnl Thickness-1/4 to 3/8" Unit Pkg.- 100</p>						
<p># Y01361</p>  <p>Standard Dome Blind Rivets Steel Rivet/Steel Mandrel Rivet Diam.-5/32" Pnl Thickness-1/8 to 1/4" Unit Pkg.- 100</p>	<p># Y14022</p>  <p>Large Flange Blind Rivets Aluminum Rivet/Steel Mandrel Rivet Diam.-1/8" Pnl Thickness-1/8 to 3/16" Unit Pkg.- 100</p>							

HARDWARE SUPPLEMENT

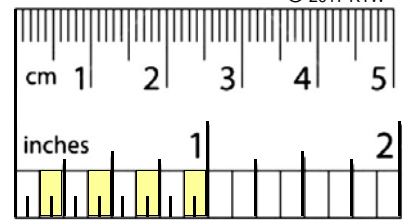

ADDITIONAL BULK



Y02341	ALUM. RVT 5/32" dia. 1/8-3/16 100 per Bag
Y02351	ALUM. RVT 5/32" dia. 3/16-1/4 100 per Bag
Y02361	ALUM. RVT 5/32" dia. 1/4-3/8 100 per Bag

YB25

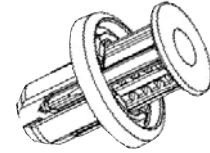

Y11069

BULK QTY - 50

Y10398



3/16" Diameter
Grip: 11/16"-13/16"
Flange Diameter: 3/4"
Aluminum Rivet
Aluminum Mandrel
Grille & Bumper
UNIT PACKAGE: 25

YB26



W3084S

BULK QTY - 250

Y19256



Stainless Steel
Bumper & Grille Retainer
Width: 13mm
Length: 30mm
Accent, Santa Fe & Sonata
1995 - On
UNIT PACKAGE: 25

YB27



Y23711

BULK QTY - 150

YB28

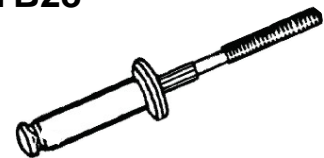

Y23761

BULK QTY - 150

ERGO TUFLOKS



ERGO TUFLOKS
ASSORTMENT DRAWER
UNIVERSAL DOMESTIC
O.E.M. FASTENERS

Assortment contains:
280 TUFLOKS
STOCK NUMBER:
X-8637

EZ-WARE
LESS IS BETTER



X10367



6.5mm Hole Size 14mm Flange Size
7.0-9.5mm Panel Range
Black Nylon Push-Type Retainers

X10368



6.5mm Hole Size 18mm Flange Size
2.0-4.5mm Panel Range
Black Nylon Push-Type Retainers

X10369



6.5mm Hole Size 18mm Flange Size
4.5-7.0mm Panel Range
Black Nylon Push-Type Retainers

X10370



8mm Hole Size 19mm Flange Size
5.0-7.0mm Panel Range
Black Nylon Push-Type Retainers

X10371

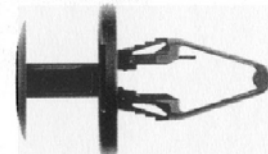

8.5mm Hole Size 20mm Flange Size
2.0-4.5mm Panel Range
Black Nylon Push-Type Retainers

X10239



8.5mm Hole Size 19mm Flange Size
2.7-5.3mm Panel Range
Black Nylon Push-Type Retainers

X10374



8.5mm Hole Size 20mm Flange Size
4.5-7.0mm Panel Range
Black Nylon Push-Type Retainers

X10372

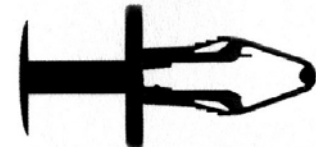

8.5mm Hole Size 20mm Flange Size
7.0-10.0mm Panel Range
Black Nylon Push-Type Retainers

X10375



9.5mm Hole Size 18mm Flange Size
2.95-5.75mm Panel Range
Black Nylon Push-Type Retainers

X10377

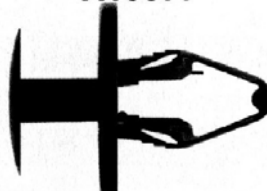

10.5mm Hole Size 25mm Flange Size
3.0-6.0mm Panel Range
Black Nylon Push-Type Retainers

X10378

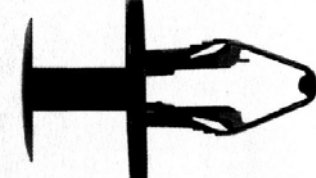

10.5mm Hole Size 25mm Flange Size
6.0-9.0mm Panel Range
Black Nylon Push-Type Retainers

The "KING OF MINI BULBS" CHART



HB 37 10 HB 24 10 HB 24NA 10
HB 74 10



HB 194 HB 194NA
HB 168 194 = 2 C.P.
All 10 168 = 3 C.P.



HB 906 6 C.P. HB 906 NA
HB 912 12 C.P. HB 916 NA
HB 916 4 C.P. All 10
HB 921 21 C.P.
HB 922 15 C.P.



HB 1003 10 HB 3496 10 HB 3497 10
Double Filament 42 / 3 Watt
Single Filament 27 Watt



HB 17171 10
Fits many of the
Volvo
Rear Lamps
5 Watt

STOCK NUMBERS ARE IN
BLACK TEXT
QUANTITIES PER BOX ARE IN
BLUE (1 or 10)

SCALE:
GRID = 1/2 INCH



HB 1157 10 HB 1157 NA 10
HB 2057 10 HB 2057 NA 10
HB 2357 10 HB 2357 NA 10
Double Filament
Double Filament



HB 1156 10 HB 1156 NA 10 HB 1295 NA 10
Single Filament 32 Watt
Single Filament 24 Watt
Single Filament



HB 7440 10 HB 7443 10
HB 7440 NA 10 HB 7443 NA 10
Single Filament
Double Filament



HB 3057 HB 3057 NA
HB 3157 HB 3157 NA
HB 3357 HB 3357 NA
HB 3457 HB 3457 NA
HB 3757 NA
All 10



HB 3155 HB 3156 HB 3156 NA HB 4057K
HB 4114K
HB 4157K
HB 4157K NA
All 10

NOTE: The difference between
similar looking bulbs is, **design**
wattage or **candle power**.
Always replace with the **exact**
same bulb number!



HB 1 1
55 Watt

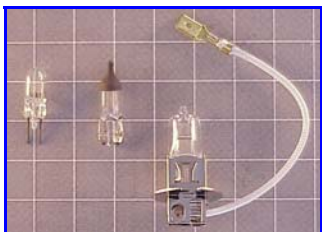

HB 891 1 HB 2040 1 HB 3 1
8 Watt 8 Watt 100 Watt



HB 272 10 HB 317 10 HB 211-2 10 HB 561 10
5 C.P. 5 C.P. 12 C.P. 12 C.P.



HB 1893 10 HB 1895 10 HB 67 10
4 Watt 4 Watt 8 Watt
HB 97 10
9 Watt

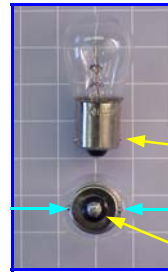

HB 1156N 10
Nickel Base
Single Filament
32 Watt

NOTE: Substituting
Brass Base bulbs for
Nickel Base Bulbs can
result in the computer
signaling bulb outage.

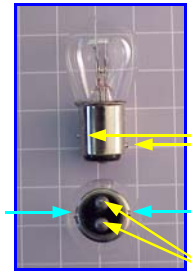

HB 1157N 10
Nickel Base
Double Filament



HB 17638 NA 10
Nickel Base
Single Filament

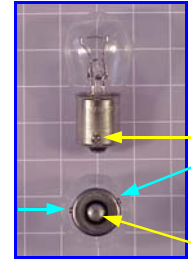

HB 17640 10
Nickel Base
Single Filament



HB 17881 10
Nickel Base
Double Filament
21 / 4 W



HB D2S 1 HB D2R 1
35 Watt P32d HID Xenon Super White 6000 K
Fits all models with separate Ballasts
35 Watt P32d HID Xenon Super White 6000 K
Fits all models with separate Ballasts



HB 8 1 HB 9 1
35 Watt 65 Watt
HB 11 1
55 Watt



HB 9011 1 HB 9012 1
65 Watt HIR Infrared
55 Watt HIR Infrared



HB 9003 1
60 / 55 Watt



HB 9004 1
65 / 45 Watt



HB 9005 1
65 Watt



HB 9006 1
55 Watt



HB 9007 1
65 / 55 Watt



HB 9008 H/13 1
60 / 55 Watt



HB 893 1 HB 894 1 HB 899 1 HB 6 1 HB 7 1
37.5 Watt 37.5 Watt 37.5 Watt 6 Watt 55 Watt



HB 881 1
27 Watt



HB 889 1
27 Watt



HB 880 1
27 Watt



HB 890 1
27 Watt



HB 9040 1
36 Watt



HB9055 1
53 Watt



HB 9145 1
45 Watt

To Re-Order CALL Toll Free:

CREST EAST COAST Inc.

1-866-458-9009

Or visit our
Website at:

WWW.CRESTEASTCOAST.COM

