

W&E SALES CO., INC.

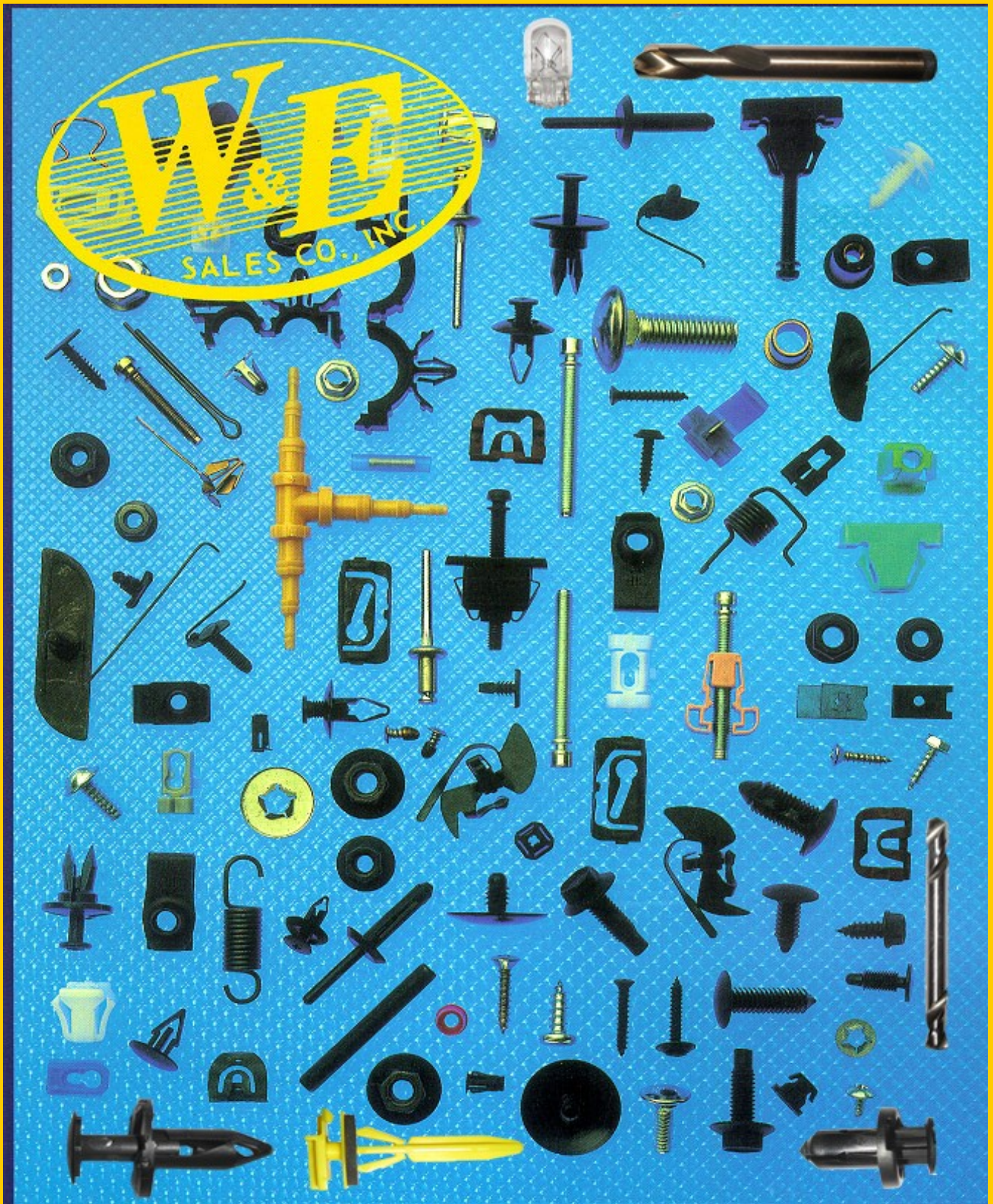

THE COMPLETE LINE OF HARDWARE & SPECIALIZED TOOLS

FOR THE AUTOBODY & AUTO GLASS SHOP

2016-2017

THE WEE PAK LINE

W&E SALES COMPANY'S SMALL PACKAGE LINE

WEE PAK RAK #1 (ORIGINAL WEE PAK RAK)

INCLUDES 144 MASTER PACKS
(576 TOTAL WEE PAKS, REVOLVING
DISPLAY RACK, 144 HOOKS, HEADER
CARD AND 5 WALL CHARTS)

PART LISTING FOR WEE PAK RAK #1
SEE PAGE 186

WEE PAK RAK #2

INCLUDES ADDITIONAL
144 MASTER PACKS
(576 TOTAL WEE PAKS, REVOLVING
DISPLAY RACK, 144 HOOKS, HEADER
CARD AND 5 WALL CHARTS)

PART LISTING FOR WEE PAK RAK #2
SEE PAGE 187



W & E SALES CO., INC.

NEWARK, NEW JERSEY

CONTENTS

<u>Product</u>	<u>Page number</u>
Acid Brushes.....	144
Assortments.....	147-170
Bin Labels.....	190
Body Bolts- Metric.....	91-94
Body Bolts- USS.....	94
Bolts-USS.....	136-137
Bolts-Metric.....	136
Bulbs: Automotive miniature.....	128-130
Bulbs: Halogen.....	131-132
Bulb sockets, pigtail connectors.....	133-134
Bumper Bolts.....	96
Bumper Bolt Retainers.....	96
Bumper Retainers-Plastic.....	20-21, 26-31,38,40-44,50-64
Bushings-Door Hinge.....	113
Cabinets-racks, storage, bins.....	172-173
Cable straps.....	122
Can clips.....	144
Clip nuts.....	88-89
Clamp bracket-(body and frame straightening).....	142
Clips- "E", push on.....	97
Clip Removal Tool.....	145
Clips-speed.....	88-89
Clips-tubular.....	109
Cotter Pins.....	119
Cowl/ Grille retainers.....	16-21,26-28,31,36,41,44,51-53,55-65
Display Case.....	191
Door glass window regulator rivets.....	70
Door handle clip removal tool.....	144
Door hinge pins, door hinge bushings.....	113-118
Door lock clips.....	66
Door trim clips.....	25-28,30-31,36-49,62-65
Drills-body panel.....	138
Drills-high speed twist.....	139
Electric connectors-solderless terminals insulated.....	123-126
Expansion test plugs.....	146
Exterior panel fasteners, plastic retainers.....	16-64
Fax Order Form.....	189
Fender retainers.....	21,24-25,27-31,42-44
Fender washers.....	137

BOOK NO. 6/16



CONTENTS

<u>Product</u>	<u>Page number</u>
Finishing sems screws.....	85
Finishing washers.....	119
Flange Nuts.....	95
Flat Washers.....	135
Foldover nuts-Metric.....	90
Foldover nuts-USS.....	85
Free spinning washer nuts.....	95
Fuses- ATO/ATC, Mini, AGC/Glass, Low profile.....	125
Glass Guides.....	66,68-69
Grille retainers.....	18-19,21,27-28,31,41,51-53,55-56,58,60-64
Grommets-plastic.....	102-108
Handle parts.....	69-71
Headlamp adjusting assemblies, nuts, screws.....	100-102
Headlamp adjusting springs.....	99
Heat shrink terminals.....	126
Heat shrinkable tubing.....	125
Hex head body bolts.....	91-94
Hinge pins (door).....	114-118
Hinge pin bushings (door).....	113,116-118
Hog rings.....	64
Hog ring pliers.....	140
Hole plugs.....	121
Hood, hood seal clips.....	26,32-35,36-38
Hose clamps.....	140
Inserts, threaded.....	109,169
License plate bolts & nuts.....	110-111
Machine screws.....	110-111,119
Machine screw nuts.....	13,97,111
Metric body bolts.....	91-93
Metric conversion table.....	143,145,156
Moulding bolts, clips, fasteners.....	12-28,30-31,67-68
Mounting hardware.....	112
Nuts-hex machine.....	13,97,111
Nuts-Locking.....	96-97
Nuts-Metric.....	95,136
Nuts-plastic.....	102-109,111
Nuts-USS.....	136-137
OEM number to W&E number cross reference guide.....	176-185
Parts boxes.....	172-173
Piano wire.....	141
Pins-Door Hinge and Door Hinge pin/bushing sets.....	114-118
Plastic cable straps.....	122



CONTENTS

Product	Page number
Plastic razor blades.....	143
Plastic rivets	76
Plastic storage boxes.....	173
Pull rods; pull rod set.....	142
Push type rivets.....	50-60
Razor blades.....	146
Retainers-headlamp	100-102
Retainers-hood.....	26,36-38
Retainers-push type.....	50-60
Retainers-screw type.....	61-64
Retainers-trim.....	13-64,67-68
Retainers-Weatherstrip.....	32-35
Rivets-plastic.....	72
Rivets-special.....	70-74
Rivets-standard.....	75
Rivet tool.....	140,142
Rivet tool (for plastic rivets).....	140
Sales Aids.....	174-175,188,190-191
Screws-black.....	81-82
Screws-bright.....	83-87
Screws-loose washer.....	77-80,85-86
Screws-specialized.....	77-87
Screw Rivets.....	61-64
Screws-Self Drilling.....	79,82,85,87
Shims.....	135
Software (fastener invoicing).....	174-175
Spot Weld Drills.....	138
Squeegees (rubber).....	144
Stud caps.....	97
Stud retainers.....	97
Tape-double sided.....	144
Thread cutting nuts.....	98
Tools and specialties.....	138-146,169
Toothed lock washers; machine screws.....	119
Trim pad removal tool.....	143
Tubular clips.....	109
Wall Charts.....	188,190
Washers Finishing.....	119
Washers-flat, lock, metric, SAE.....	137
Weatherstrip clips.....	32-35
Weatherstrip-door and trunk.....	141
Wee Pak Raks.....	Inside Front Cover
Wee Pak Rak #1 parts listing.....	186

CONTENTS

<u>Product</u>	<u>Page number</u>
Wee Pak Rak #2 parts listing.....	187
"We Trak" Fastener Invoicing Software.....	174-175
Window Riser Knobs.....	69
Windshield and rear window moulding clips.....	67-68
Wire Harness clips.....	120,122
Wire loom.....	127
Wire-piano.....	141
Wire-electrical.....	146
Wire-windshield.....	139



Part #	Page	Part #	Page	Part #	Page	Part #	Page	Part #	Page	Part #	Page
1/16 Drill	139	432	123	676	82	885	97	1077	119	2164	88
1/2 Drill	139	433	123	680	83	886	97	1078	119	2165	15
1/4 Drill	139	434	123	682	83	887	97	1079	119	2167	119
1/8 Drill	139	437	123	683	83	888	97	1205	45	2168	119
3/16 Drill	139	440	123	684	83	889	97	1206	32	2169	119
3/32 Drill	139	441	123	685	83	890	97	1210	64	2170	119
3/8 Drill	139	442	123	686	83	910	89	1212	64	2171	119
4LR	172	443	123	687	83	911	89	1213	64	2172	119
5/16 Drill	139	444	123	689	83	915	89	1220	64	2173	103
5/32 Drill	139	445	123	728	96	916	89	1222	36	2175	18
5/64 Drill	139	446	123	729	96	917	89	1223	36	2176	68
7/16 Drill	139	448	123	730	96	920	98	1224	36	2178	99
7/32 Drill	139	449	123	731	96	921	98	1225	40	2179	99
7/64 Drill	139	450	125	732	96	922	98	1250	14,75	2183	112
9/32 Drill	139	451	125	733	96	923	98	1262	69	2184	84
9/64 Drill	139	452	125	740	96	929	97	1290	66	2185	84
11/32 Drill	139	453	125	741	96	940	94	1411	119	2186	84
11/64 Drill	139	454	124	760	96	942	94	1415	119	2187	84
13/32 Drill	139	455	123	761	96	943	94	1420	119	2189	84
13/64 Drill	139	501	83	762	96	944	94	1651	84	2190	45
15/32 Drill	139	505	83	763	96	945	94	1652	84	2193	77
15/64 Drill	139	509	83	764	96	951	137	1653	84	2194	75
17/64 Drill	139	537	83,110	765	96	952	137	1659	84	2195	18
18D	172	575	86	766	96	953	137	1725	152	2196	18
19/64 Drill	139	579	86	767	96	957	137	2101	103	2197	14
21/64 Drill	139	580	86	775	97	963	111	2102	122	2199	45
23/64 Drill	139	582	86	776	97	965	135	2104	51	2200	64
25/64 Drill	139	586	86	777	13,97	966	135	2105	45	2203	86,110
27/64 Drill	139	587	86	778	97	969	135	2107	40	2204	40
29/64 Drill	139	588	86	779	97	970	135	2108	40	2207	32
30	141	590	86	780	97	971	135	2109	22	2208	103
31	141	593	86	786	97	972	135	2116	100	2210	103
31/64 Drill	139	596	86	787	97	973	135	2117	45	2211	102
36B	172	597	86	788	97	974	135	2119	100	2212	102
146	13	598	86	789	97	975	135	2120	122	2213	103
147	13	599	86	793	97	985	75	2121	70	2214	104
150	13	601	86	797	95	986	75	2122	70	2216	50
156	13	602	86	798	95	988	122	2123	70	2219	120
161	13	603	86	799	95	989	122	2124	101	2220	89
175	13	620	83	800	95	990	122	2126	122	2221	15
332	13	621	83	810	120	991	122	2127	14	2222	87
333	13	622	83	811	88	999	64	2129	120	2223	50
336	13	625	87	814	88	1010	100	2130	75	2224	45
341	14	628	83	815	103	1011	100	2131	75	2225	80
345	14	629	83	817	103	1012	100	2132	75	2226	80
349	14	631	83	818	103,111	1013	100	2133	75	2227	81
350	14	633	83	819	103	1024	99	2134	75	2229	15
351	14	635	83	822	103	1025	100	2135	75	2230	36
352	14	636	83	825	103	1034	100	2136	75	2231	96
353	67	637	83	826	103,111	1036	119	2137	75	2232	15
354	67	638	83	829	99	1037	119	2138	75	2235	101
355	67	639	83	830	99	1038	119	2139	75	2236	104
371	67	641	83	832	102	1039	119	2140	40	2237	60
373	67	643	83	835	101	1040	101	2142	14	2240	84
378	67	646	83	837	101	1041	101	2143	99	2244	104
379	67	654	83	839	101	1042	119	2144	100	2245	109
384	67	655	83	840	99	1044	119	2146	120	2246	45
385	67	656	83	842	99	1050	96	2147	121	2247	104
386	67	657	83	844	102	1051	96	2148	82	2248	102
387	67	658	83	846	88	1052	96	2149	82	2249	69
389	68	659	83	852	88	1061	119	2150	85	2250	69
390	68	660	83	853	88	1062	119	2154	109,169	2251	69
421	123	663	83	858	88	1063	119	2155	109,169	2254	15
424	123	667	83	859	88	1064	119	2156	109,169	2255	89
425	123	670	83	860	88	1065	119	2158	119	2256	77
426	123	671	87	861	88	1071	119	2159	119	2257	32
427	123	672	68,87	874	109	1072	119	2160	119	2259	87
428	123	673	82	875	109	1073	119	2161	112	2260	83
429	123	674	82	878	109	1074	119	2162	75	2263	75
430	123	675	82	879	109	1075	119	2163	14	2264	76



Part #	Page	Part #	Page	Part #	Page	Part #	Page	Part #	Page	Part #	Page
2265	76	2357	114	2432	112	2511	46	2584	80	2661	111
2266	76	2358	114	2434	137	2512	42	2585	81	2662	111
2267	76	2359	114	2435	137	2513	84	2586	81	2663	110
2268	101	2360	114	2436	137	2514	77	2588	75	2665	81
2269	122	2361	60	2437	51	2515	119	2589	75	2667	125
2270	76	2363	39	2438	51	2518	119	2590	75	2668	125
2271	86	2364	39	2439	76	2519	86	2591	86	2669	125
2272	112	2365	41	2440	65	2520	86	2592	61	2670	125
2273	66	2366	60	2441	65	2521	75	2593	137	2671	125
2274	45	2367	41	2442	65	2522	112	2594	137	2672	125
2275	85	2368	18	2443	65	2523	35	2595	125	2673	125
2277	104	2369	18	2444	110	2524	112	2596	125	2674	125
2278	39	2370	17	2446	110	2525	111	2597	83	2675	16
2279	41	2371	68	2447	87	2526	112	2598	19	2676	65
2280	68	2372	20	2448	135	2527	111	2599	52	2677	39
2281	113	2373	39	2449	135	2528	82	2600	116	2678	37
2282	113	2374	104	2450	87	2529	82	2601	137	2679	32
2283	113	2375	45	2452	70	2530	137	2602	137	2680	42
2284	113	2376	68	2453	51	2531	137	2603	137	2681	105
2285	112	2378	17	2454	83	2532	137	2604	137	2682	62
2286	45	2379	32	2455	39	2533	137	2605	137	2683	105
2287	77	2381	104	2456	101	2534	102	2607	65	2684	78
2289	120	2382	87	2457	113	2535	101	2608	18	2685	82
2290	120	2383	99	2458	51	2536	75	2609	61	2686	62
2291	45	2384	20	2459	41	2537	75	2610	102	2687	35
2296	82	2385	122	2460	60	2538	66	2611	102	2688	72,75
2297	82	2386	122	2461	42	2539	105	2612	52	2689	127
2298	68	2387	65	2462	46	2540	127	2613	61	2690	127
2299	41	2388	50	2463	85	2541	127	2614	52	2691	127
2300	18	2389	83	2464	97	2542	127	2615	52	2692	127
2301	15	2390	83	2465	97	2543	127	2617	52	2693	127
2303	15	2391	83	2466	97	2544	127	2618	32	2694	127
2304	109	2392	83	2467	97	2545	127	2619	61	2695	127
2305	104	2393	83	2468	97	2546	120	2620	85	2696	127
2306	15	2394	83	2469	97	2547	110	2621	46	2697	127
2308	15	2395	83	2470	75	2548	61	2622	70	2698	127
2310	15	2396	83	2471	75	2549	61	2623	81	2699	52
2311	15	2397	83	2472	75	2550	51	2624	61	2700	102
2315	15	2398	50	2473	104	2551	51	2625	66	2701	52
2317	16	2399	50	2475	61	2552	46	2627	61	2702	121
2319	82	2400	109	2477	61	2553	127	2628	32	2703	68
2320	82	2401	82	2478	51	2554	127	2629	42	2704	110
2321	71	2402	13	2479	105	2555	127	2630	72	2705	46
2322	77	2403	87	2480	72	2556	127	2632	16	2706	39
2324	112	2404	87	2482	85	2557	80	2633	16	2707	46
2325	81	2405	60	2484	85	2558	80	2634	78	2708	89
2326	110	2406	104	2485	76	2560	65	2635	114	2714	114
2327	113	2407	41	2486	85	2561	39	2637	113	2715	82
2328	77	2408	17	2488	86	2562	98	2638	115	2716	62
2329	77	2409	85	2489	77	2563	70	2639	113	2717	52
2330	71	2411	83	2490	46	2564	140	2640	76	2718	62
2331	82	2412	83	2491	61	2565	140	2641	76	2719	62
2332	82	2413	50	2492	39	2566	140	2642	76	2720	105
2333	82	2414	32	2493	36	2567	140	2643	42	2721	46
2334	82	2415	60	2494	105	2568	140	2644	42	2722	121
2335	82	2416	46	2495	29	2569	140	2645	97	2723	121
2336	15	2417	46	2496	29	2570	140	2646	97	2724	121
2338	102	2418	41	2497	122	2571	140	2647	97	2725	121
2339	104	2419	16	2498	84	2572	97	2648	97	2726	46
2340	82	2420	51	2499	84	2573	97	2649	19	2727	47
2341	87	2421	14,16	2500	84	2574	97	2650	19	2728	70
2342	77	2422	120	2501	84	2575	81	2651	18	2729	52
2343	82	2423	77	2502	105	2576	124	2652	32	2730	78
2345	81	2424	82	2503	105	2577	124	2653	76	2733	85
2346	88	2425	36	2504	39	2578	18	2655	61	2734	85
2347	41	2426	121	2505	66	2579	69	2656	36	2735	85
2353	71	2427	121	2506	66	2580	102	2657	85	2736	85
2354	71	2428	121	2507	66	2581	105	2658	85	2738	85
2355	76	2430	121	2508	66	2582	29	2659	85	2739	53
2356	41	2431	121	2509	66	2583	36	2660	85	2740	113

Part #	Page	Part #	Page	Part #	Page	Part #	Page	Part #	Page	Part #	Page
2741	113	2815	126	2887	53	2959	54	3030	133	3103	33
2742	82	2816	126	2888	72,99	2960	17	3031	133	3104	34
2743	82	2817	126	2889	53	2961	35	3032	133	3105	34
2744	84	2818	126	2890	71	2962	47	3033	133	3106	34
2745	84	2819	126	2891	71	2963	106	3034	133	3107	34
2746	78,84	2820	126	2892	17	2964	35	3035	22	3108	23
2747	94	2821	126	2893	47	2965	106	3036	22	3109	56
2748	118	2822	126	2894	29	2966	35	3037	48	3110	79
2749	72	2823	126	2895	110	2967	37	3038	55	3111	79
2750	72	2824	126	2896	115	2968	20	3039	17	3112	63
2751	89	2825	126	2897	62	2969	106	3040	55	3113	63
2752	37	2826	126	2898	53	2970	106	3041	48	3114	49
2753	116	2827	126	2899	47	2971	35	3042	22	3116	23
2754	140	2828	126	2900	42	2972	37	3043	22	3117	79
2755	22	2829	126	2901	117	2973	37	3044	22	3118	80
2756	105	2830	126	2902	53	2974	54	3045	69	3119	38
2757	53	2831	126	2903	109,169	2975	69	3046	48	3120	93
2758	62	2832	126	2904	109,169	2976	43	3047	48	3121	94
2759	32	2833	126	2905	82	2977	63	3048	48	3122	127
2760	39	2834	126	2906	112	2978	48	3049	22	3123	127
2762	82	2835	126	2907	112	2979	69	3050	79	3124	127
2763	84	2836	111	2908	68	2980	98	3051	79	3125	127
2764	85	2837	112	2909	127	2981	79	3052	84	3126	127
2765	85	2838	82	2910	29	2982	109	3053	92	3127	127
2766	32	2839	82	2911	29	2983	37	3054	93	3128	127
2767	65	2840	81	2912	54	2984	106	3055	17	3129	23
2768	105	2841	81	2913	37	2985	54	3056	43	3130	21
2769	16	2842	84	2914	127	2986	54	3058	38	3131	21
2770	122	2843	84	2915	127	2987	55	3059	49	3132	56
2771	122	2844	32	2916	127	2988	121	3060	19	3133	56
2772	111	2845	32	2917	127	2989	121	3061	19	3134	124
2773	111	2846	133	2918	127	2990	33	3062	107	3135	124
2774	70	2847	133	2919	31	2991	55	3063	107	3136	124
2775	71	2848	33	2920	78	2992	43	3064	43	3137	124
2776	71	2849	47	2921	81	2993	38	3065	16	3138	125
2777	80	2850	105	2922	81	2994	117	3066	121	3139	125
2778	80	2851	47	2923	33	2995	118	3067	97	3140	124
2779	110	2852	72	2924	33	2996	85	3068	85	3141	124
2780	17	2853	78	2925	33	2997	85	3069	85	3142	124
2781	83	2854	120	2926	89	2998	85	3070	118	3143	124
2782	78	2855	120	2927	37	2999	85	3071	118	3144	135
2783	86	2856	75	2928	75	3000	85	3072	107	3145	135
2784	17	2857	75	2929	75	3001	85	3073	107	3146	107
2785	39	2858	72	2931	54	3002	69	3074	23	3147	110
2786	17	2859	80	2932	54	3003	69	3075	33	3148	117
2787	81	2860	87	2933	33	3004	48	3076	30	3149	109,169
2790	98	2861	42	2934	133	3005	43	3077	30	3150	17
2791	97	2862	127	2935	19	3006	43	3078	55	3151	113
2792	75	2863	42	2936	19	3007	43	3079	55	3152	115
2793	119	2864	47	2937	19	3008	43	3080	66	3153	116
2794	47	2865	122	2938	69	3009	43	3081	17	3154	113
2795	47	2866	106	2939	47	3010	40	3082	19	3158	116
2796	85	2868	127	2940	78	3011	33	3083	38	3159	116
2797	85	2869	127	2942	63	3012	66	3084	111	3160	113
2798	85	2870	127	2943	115	3013	63	3085	109,169	3161	116
2800	78	2871	127	2944	115	3014	33	3088	91	3162	116
2801	37	2872	127	2945	31	3015	79,85	3089	93	3163	116
2802	83	2873	127	2946	31	3016	79,85	3090	111	3164	118
2803	86	2874	127	2947	106	3017	48	3091	20	3165	116
2804	82	2875	127	2948	47	3018	55	3092	107	3166	34
2805	82	2876	127	2949	117	3019	55	3093	56	3167	34
2806	121	2877	127	2950	117	3020	106	3094	35	3168	107
2807	121	2878	127	2951	66	3021	106	3095	49	3169	107
2808	127	2879	109	2952	42	3022	106	3096	83	3170	44
2809	31	2881	80	2953	54	3023	55	3097	44	3171	56
2810	112	2882	62	2954	69	3024	63	3098	44	3172	29
2811	126	2883	53	2955	69	3025	106	3099	44	3173	20
2812	126	2884	62	2956	66	3026	106	3100	33	3174	20
2813	126	2885	53	2957	37	3027	71	3101	79	3175	34
2814	126	2886	53	2958	54	3029	133	3102	93	3176	20



Part #	Page	Part #	Page	Part #	Page	Part #	Page	Part #	Page	Part #	Page
3177	20	3247	74	3317	77	3388	25	4137	136	5927	92
3178	34	3248	74	3318	49	3389	21	4145	136	5928	98
3179	34	3249	74	3319	93	3390	25	4147	136	5931	95
3180	111	3250	74	3320	94	3391	25	4149	136	5932	92
3181	111	3251	74	3321	94	3392	99	4200	137	5936	90
3182	56	3252	74	3322	24	3393	21	4201	137	5938	95
3183	111	3253	74	3323	122	3394	25	4202	137	5940	93
3184	98	3254	58	3324	134	3395	25	4203	137	5941	95
3185	21	3255	81	3325	24	3396	26	4204	137	5942	109,169
3186	30	3256	81	3326	59	3397	18	4205	137	5943	109,169
3187	56	3257	80	3327	59	3398	64	4210	137	5944	109,169
3188	30	3258	91	3328	66	3399	25	4211	137	5945	96
3189	121	3259	93	3329	110	3400	26	4212	137	5946	98
3190	73	3260	58	3330	31	3401	91	4213	137	5947	92
3191	21	3261	44	3331	16	3402	109	4214	137	5948	95
3192	73	3262	21	3332	72	3403	26	4215	137	5949	137
3193	73	3263	58	3333	108	3404	26	5004	136	5950	137
3194	56	3264	108	3334	108	3405	25	5005	136	5951	137
3195	134	3265	23	3335	67	3406	25	5006	136	5952	93
3196	134	3266	23	3336	35	3407	25	5008	136	5953	91
3197	134	3267	30	3337	30	3408	26	5010	136	5954	91
3198	134	3268	108	3338	108	3409	27	5012	136	5955	92
3199	134	3269	18	3339	108	3410	27	5102	136	5956	137
3200	134	3270	48	3340	89	3411	27	5103	136	5957	137
3201	134	3271	108	3341	35	3412	27	5104	136	5958	137
3202	56	3272	63	3342	38	3413	27	5106	136	5959	110
3203	40	3273	58	3343	65	3414	27	5108	136	5960	110
3204	20	3274	63	3344	50	3415	27	5110	136	5961	96
3205	35	3275	58	3345	50	3416	78	5124	136	5962	92
3206	65	3276	23	3346	60	3417	27	5126	136	5963	93
3207	107	3277	64	3347	64	3418	31	5401	136	5965	95
3208	38	3278	23	3348	24	3419	27	5402	136	5967	91
3209	65	3279	30	3349	30	3420	28	5501	136	5968	93
3210	57	3280	23	3350	18	3421	28	5502	136	5970	137
3211	108	3281	108	3351	18	3422	72	5601	136	5971	137
3212	57	3282	24	3352	31	3423	28	5602	136	5972	137
3213	134	3283	133	3353	45	3424	73	5603	136	5973	137
3214	57	3284	44	3354	108	3425	28	5604	136	5974	109,169
3215	57	3285	59	3355	30	3426	28	5606	136	5975	95
3216	57	3286	24	3356	64	3427	28	5608	136	5976	92
3217	73	3287	64	3358	23	3428	28	5801	136	5977	94
3218	40	3288	73	3359	64	3429	28	5802	136	5980	91
3219	73	3289	73	3360	21	3430	28	5803	136	5982	96
3220	73	3290	31	3361	31	3431	52	5804	136	5983	95
3221	110	3291	31	3362	60	4001	136	5805	136	5985	91
3222	137	3292	29	3363	38	4002	136	5806	136	5987	91
3223	137	3293	44	3364	44	4003	136	5808	136	5988	91
3224	57	3294	21	3365	44	4004	136	5810	136	5989	90
3225	29	3295	59	3366	16	4005	136	5901	90	5990	98
3226	63	3296	49	3367	59	4101	136	5902	90	5991	94
3227	134	3297	44	3368	16	4102	136	5903	90	6000	142
3228	49	3298	73	3369	59	4103	136	5904	90	ACC-131	168
3229	57	3299	49	3370	16	4104	136	5905	91	AFA-12	162
3230	49	3300	109,169	3371	60	4105	136	5906	91	AF-100	162
3231	38	3301	30	3372	60	4107	136	5908	95	B-12	173
3232	57	3302	108	3373	77	4112	136	5909	95	B-16	173
3233	29	3303	34	3374	37	4113	136	5910	92	B-24	173
3234	29	3304	59	3375	31	4114	136	5911	92	BL-150	190
3235	57	3305	38	3376	111	4115	136	5913	98	BPD-1/8	138
3236	84	3306	59	3377	50	4117	136	5914	98	BPD-7/64	138
3237	102	3307	59	3378	45	4119	136	5916	96	BPX-1/4	138
3238	80	3308	60	3379	85	4122	136	5917	96	BPX-1/8	138
3239	35	3309	24	3380	26	4123	136	5918	96	BPX-11	138
3240	35	3310	24	3381	26	4124	136	5919	96	BPX-30	138
3241	63	3311	44	3382	60	4125	136	5920	90	BRG-1	142
3242	58	3312	24	3383	26	4126	136	5921	92	BSWD-83	138
3243	110	3313	24	3384	30	4127	136	5922	95	BUS-24	162
3244	58	3314	84	3385	111	4129	136	5923	92	CC-9-100	144
3245	58	3315	49	3386	26	4133	136	5924	90	CC-9-M	144
3246	58	3316	78	3387	20	4135	136	5925	96	CFS-40	162









Part #	Page	Part #	Page	Part #	Page	Part #	Page	Part #	Page	Part #	Page
CLN-340	155	NT11-1024	169	RB-1	146	MHL-899	132	3497	129		
CNA-102	162	NT11-1/4-20		RB-8	143	PR-2	129	3757NA	130		
CNA-145	162		169	SD-1402	147	PR-12	129	4057K	130		
CPN-250	162	NT11-5/16-18		SD-1403	147	T161	128	4114K	130		
CRA-500	154		169	SD-1404	148	T24	128	4157K	130		
CRT-1	145	NT-15M		SD-1406	148	T24NA	128	4157NAK	130		
CR-4	172		165,169	SD-1407	149	T916	128	7440	129		
CR-6	172	NT15M-4	169	SD-1455	149	T921	128	7440NA	129		
CTA-400	168	NT15M-5	169	SD-1465	150	T922	128	7441	129		
DI-3	139	NT15M-6	169	SD-1466	150	T1034	128	7443	129		
DI-5	139	NT15M-8	169	SD-1467	151	T1073	129	7443NA	129		
DI-9	139	NT15M-10	169	SD-1470	151	T2357	129	7444NA	129		
DISP-1	191	OE CROSS		SD-2100	152	37	128	9003	131		
DISP-3	191	REF.- 176-185		SD-5900	153	53	128	9004	131		
DL-24	173	PB-18	172	SEMS-70	166	57	128	9005	131		
DRC-300	162	PD-121		SQ-2000	144	67	128	9005SX	131		
DRP-1	114		159,160	SRA-100	166	73	128	9006	131		
DS-13	139	PD-122		STGA-195	166	74	128	9006SX	131		
DS-15	139		159,160	SWD-8	138	89	128	9007	131		
DS-29	139	PD-123		SWD-10	138	90	128	9011	131		
ECA-130	164		159,160	TCA-290	166	93	128	12023	129		
EFA-1	170	PD-124		TCN-400	155	97	128	12498	129		
EFA-2	170		159,160	TEK-530	168	158	128	12516	129		
EFA-3	170	PD-125		TP-50	144	168	128	12594	129		
EFA-4	170		159,160	TKS-105	166	194	128	12814	129		
EFA-5	171	PD-126		TXS-110	166	194NA	128	12818	130		
EP-0	146		159,160	VTA-26	166	199	128	12821	129		
EP-00	146	PD-127		VTC-50		211-2	130	12844	130		
EP-3	146		159,161		121,164	272	130	12854	130		
EP-4	146	PD-128		WEE PAK		317	130	12866	130		
EP-5	146		159,161	RAKS IFC		561	130	12961	129		
EP-6	146	PD-129				904	128	17638NA	129		
EP-7	146		159,161	WEE PAK#1		906	128	17640	129		
EP-8	146	PD-130		PARTS LIST		906NA	128				
EP-9	146		159,161	PAGE 186		912	128				
EP-10	146	PD-131				912NA	128				
EP-11	146		159,161	WEE PAK #2		916NA	128				
EP-12	146	PD-132		PARTS LIST		921NA	128				
EPS-13	146		159,161	PAGE 187		1003	128				
EW-14	146	PD-133				1004	128				
FA-100	144		159,161	WECD	190	1141	129				
FA-176	144	PL-12	173	WE TRAK	174	1142	129				
FA-300	144	PL-24	173	WETRAK3		1156	129				
FAX ORDER		PLA-801	157		174	1156NA	129				
FORM	189	PLA-802	157	WE TRAK		1157	129				
FL-1400	167	PLA-803	157	WORKSHEET		1157N	129				
GM-160	144	PLA-804	157		175	1157NA	129				
GMT-25	163	PLA-805	157	WTUE	174	1295	129				
HG-8	140	PLA-806	157	WTUCD	174	1295NA	129				
HLN-75	164	PLA-807	157	WK-3	141	1445	129				
HPB-9	163	PLA-808	158	WSC-240	153	1816	129				
HPB-17	163	PLA-809	158	WW-72	141	1891	129				
HST-65		PLA-810	158			1893	129				
	126,154	PLA-811	158			1895	129				
LPN-46	164	PLA-812	158	<u>BULBS</u>		2040	132				
M-602	173	PLA-813	158	D2R	132	2057	129				
MC-1	190	PLR-5	173	D2S	132	2057NA	129				
MC-2	190	POCA-402	165	H-1	131	2357NA	129				
MC-3	190	POS-150	165	H-3	131	3057	130				
MC-4	190	POS-160	165	H-7	131	3057NA	130				
MC-5	190	POS-260	165	H-8	131	3155	130				
MINI CHART		PPS-255	165	H-9	131	3156	130				
PARTS LIST		PR-200	142	H-10	131	3156NA	130				
	188	PR-200-1	142	H-11	131	3157	130				
MET-501	164	PRG-30	140	H-12	131	3157NA	130				
MET-502	164	PRT-70	155	H-13	131	3357	130				
MFA-50	165	PT-217	143	MHL-880	131	3357NA	130				
MW-1000	167	PTR-241	158	MHL-889	131	3457	130				
NRA-60	156	PW-15	141	MHL-890	131	3457NA	130				
NT-11	169	QEC-120	165	MHL-891	132	3496	129				



NOTES

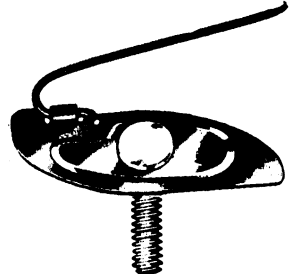
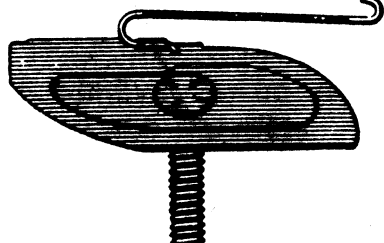
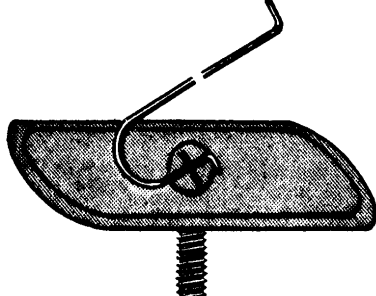

MOULDING BOLTS & CLIPS

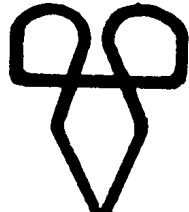
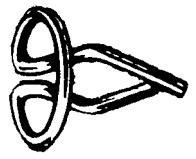
<p>146</p>  <p>(1624705, 6010093) (PLATE SIZE-7/8X21/64") 10-24 x 3/4"SCREW OLDSMOBILE, CADILLAC, CHEVROLET, FORD, CHRYSLER UNIT PKG.-25</p>	<p>147</p>  <p>10-24 x 3/4"SCREW (PLATE SIZE-1/2X1") GM,CHRYSLER, FORD, RAMBLER UNIT PKG.-25</p>	<p>150</p>  <p>10-24 x 3/4" SCREW (PLATE-5/8X1-3/8") GENERAL MOTORS, CHRYSLER, RAMBLER UNIT PKG.-25</p>	
<p>156</p>  <p>10-24 x 5/8" SCREW (PLATE SIZE:1/2X1-3/4") CHEVROLET, CHRYSLER FORD & RAMBLER UNIT PKG.-25</p>	<p>161</p>  <p>(4676189) 10-24 x 3/4"SCREW (PLATE SIZE-11/16X2-1/2") GM-CHEVROLET & BUICK UNIT PKG.-15</p>	<p>175</p>  <p>(OE 1484570) PUSH-IN (BLIND) MOULDING FASTENER (TOP:13/16" LONG X 3/8"WIDE) GM & UNIVERSAL UNIT PKG.-25</p>	
		<p>777</p>  <p>10-24 HEX NUT-PLATED UNIT PKG.-100</p>	
<p>332</p>  <p>7/16" X 9/16" SIDE MOULDING CLIP UNIT PKG.-50</p>	<p>333</p>  <p>1/2" X 11/16" SIDE MOULDING CLIP UNIT PKG.-50</p>	<p>336</p>  <p>7/8" X 1" SIDE MOULDING CLIP UNIT PKG.-25</p>	<p>2402</p>  <p>(6002092) WIRE MOULDING CLIP 3/4" MOULDINGS CHRYSLER & UNIVERSAL UNIT PKG.-100</p>

MOULDING CLIPS

341



(OE-873359)
(REPLACES-4492962)
PLASTIC QUARTER PANEL,
DOOR, WHEEL OPENING,
AND NARROW VINYL TOP
MOULDING
ALL GM CARS- '66-'72
& UNIVERSAL
UNIT PKG.-50

345



(7731589)
LANDAU TOP
MOULDING CLIP
(ALL MAKES & MODELS)
ALSO; QUARTER PANEL
REVEAL MOULDING CLIP
GM PRODUCTS
UNIT PKG.-50

349

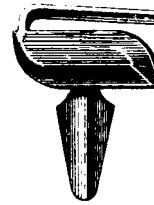

MOULDING FASTENER-NYLON
FOR 1/2" TO 5/8" MOULDINGS
UNIVERSAL & VW MODELS
UNIT PKG.-50

350



(OE-4853108)
CHEVROLET DOOR & QUARTER
PANEL (USE IN 3/8" HOLE)
UNIT PKG.-50

351

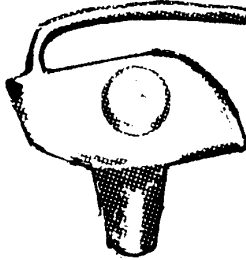

(OE-4883164)
GENERAL MOTORS DOOR
AND QUARTER PANEL
USE IN 3/8" HOLE
UNIT PKG.-50

352

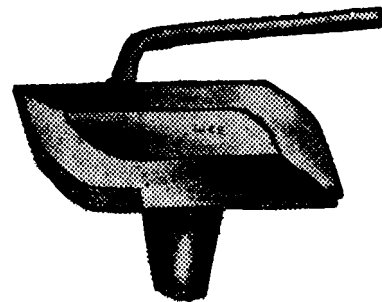

UNIVERSAL MOULDING CLIP
RANGE: 1-1/4"-1-3/4"
USE IN 3/8" HOLE
UNIT PKG.-25

2421

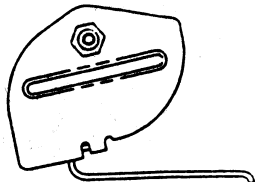

(OE-E9VB5420884AA)
DOOR MOULDING RETAINER
4 MM THREAD
FORD/LINCOLN -'80 & UP
UNIT PKG.-10

1250



ALL ALUMINUM SMALL
FLANGE BLIND RIVET
RIVET DIAMETER- 1/8"
PANEL RANGE- 1/8"- 1/4"
USE WITH PLASTIC
FASTENER &
GENERAL PURPOSE
UNIT PKG.-250

2142

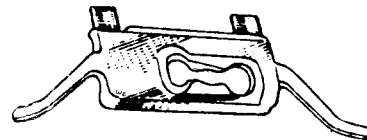

(OE-6003632)
PLASTIC CLIP-FENDER
TO WHEELHOUSE MOULDING
CHRYSLER-'77 & UP
UNIT PKG.-50

2127

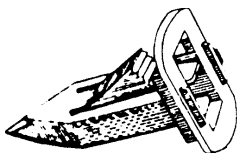

(9617200)
NYLON HEADLINER CLIP
ROOF, FRONT & REAR INNER
SIDE PANEL-MOST GM CARS
UNIT PKG.-25

2163

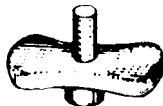

(OE-1247708)
MOULDING CLIP
VOLVO- '67 & UP
UNIT PKG.-50

2197



(OE-000-988-1581)
PLASTIC SIDE MOULDING CLIP
MERCEDES-250/280, 350SL
RED COLOR
UNIT PKG.-100

MOULDING CLIPS

2221
(8727925)
(20028569)

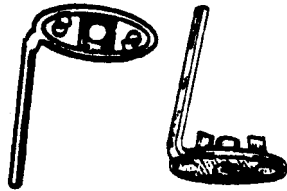

**FASTENER- FRONT AND REAR
DOOR MOULDING- GM '75-'77
UNIT PKG.-25**

2165



(OE-8799350)
**NYLON MOULDING CLIP
QUARTER PANEL & BELT
GM CARS- '70-'77
UNIT PKG.-50**

2232

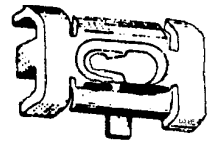

OE-20175051), (15633873)
**QUARTER BELT REVEAL
MOULDING CLIP
GM- '80 & UP
UNIT PKG.-25**

2336

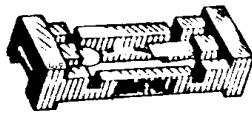

(OE-14022878)
**PLASTIC MOULDING CLIP
GM- '80 & UP
UNIT PKG.-25**

2229



(OE-20199675)
**BELT MOULDING CLIP-NARROW
GM '80 & UP
UNIT PKG.-25**

2303



VW (OE-411-853-575)
BMW (OE-5113-6440-146)
**SIDE MOULDING CLIP
VOLKSWAGEN AND BMW
UNIT PKG.-25**

2308

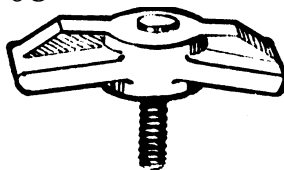

(OE-5113-1869-559)
**BODY MOULDING
T-BOLT-BMW
UNIT PKG.-15**

2254



(OE-326177, 2193101)
**SIDE & TAILGATE
MOULDING CLIP
CHEV. SUBURBAN &
GM LIGHT TRUCKS
UNIT PKG.-25**

2301



(OE-803-353-577)
**PLASTIC MOULDING
CLIP
VOLKSWAGEN
UNIT PKG.-25**

2306

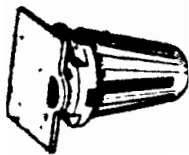

(OE-5147-840-961)
**PLASTIC NUT
PLUG-BMW
UNIT PKG.-25**

2315



(OE-000-988-6081)
**PLASTIC
MOULDING CLIP
MERCEDES BENZ
UNIT PKG.-25**

2311



(OE-5113-1849-724)
**PLASTIC MOULDING
FASTENER
BMW
UNIT PKG.-10**

2310

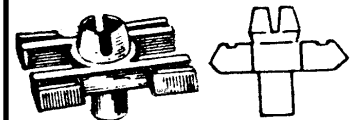

(OE-5113-1816-019)
**PLASTIC MOULDING
FASTENER
BMW
UNIT PKG.-15**

MOULDING / GRILLE RETAINERS

2421

(E9VB5420884AA)

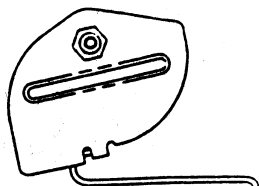

DOOR MOULDING RETAINER
4 MM THREAD
FORD-LINCOLN ('80 & UP)
UNIT PKG.-10

2419



(OE-E7ZB61209808AC)
**DOOR RETAINER-
OUTSIDE BELT MOULDING**
FORD MUSTANG
1987 & UP
UNIT PKG.-25

2317

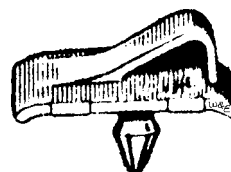

(OE-000-988-7881)
PLASTIC MOULDING FASTENER
MERCEDES BENZ
UNIT PKG.-25

3331

(11588650)

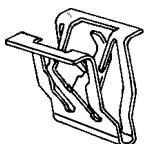

**RETAINER-INT. TRIM PANEL, BEZEL
SCUFF PLATE & WINDSHIELD TRIM**
(12MM WIDE X 17MM HIGH)
GM CARS & LIGHT TRUCKS-'02 & UP
UNIT PKG.-10

3065

(4805770AA)

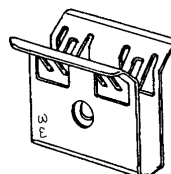

GRILLE COVER RETAINER
25 MM OVERALL HEIGHT
25 MM WIDTH
CHRYSLER MINIVANS-'96 & UP
UNIT PKG.-10

2769

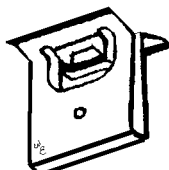

(25606274)
**RETAINER-SIDE MARKER,
PARKING LIGHT &
REAR BUMPER
REFLECTOR- GM**

UNIT PKG.-25

2632



(OE-91501-SG0-003)
**BODY SIDE
MOULDING CLIP**
ACURA-'87 & UP

UNIT PKG.-25

2633



(OE-91534-SE0-000)
**BODY SIDE
MOULDING CLIP**
HONDA-'86 & UP

UNIT PKG.-25

2675



(15686142;repl. 11561448)
RADIATOR GRILLE NUT
#8 SCREW
ZINC PHOSPHATE
GM TRUCKS- '93 & UP

UNIT PKG.-25

3366



(53326-52010)
PLASTIC HOOD MOULDING CLIP
TOYOTA- COROLLA,
MATRIX, PRIUS & SIENNA
2009 & UP
UNIT PKG.-10

FOR 11 X 21 MM HOLE

3368

(75395-33030)



**PLASTIC MOULDING
RETAINER W/ SEALER**
FENDER TRIM & DOOR PANELS
TOYOTA/LEXUS
ES 300 & RX 300
1999-UP
UNIT PKG.-15

HOLE SIZE- 9 MM
FLANGE- 18 MM
O/A LENGTH- 18 MM

3370

(W708771-S300)

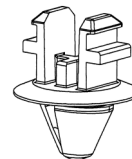

**PLASTIC RETAINER-COWL VENT,
RADIATOR SHROUD & AIR DEFLECTOR**
FORD/LINCOLN
FULL SIZE SUV'S
2003-UP
UNIT PKG.-25

HOLE SIZE- 10 X 15 MM
O/A LENGTH- 24 MM

MOULDING /GRILLE CLIPS

2780



(N807872-S32B)
**RETAINER-
 REAR & SIDE LIGHTS**
 PANEL THICKNESS:
 (.157"-.173")
 FORD- '93 & UP
 UNIT PKG.-25

2784



(N806624-S191); (6502776)
**SIDE & REAR LIGHT
 ASSEMBLY CLIP**
 (.034"-.043") THICK PANEL
 FORD & CHRYSLER
 UNIT PKG.-25

2786



(22642007)
RETAINER-FENDER BRACKET
 4.2-1.81MM
 (#8) SCREW SIZE
 8.5 MM SQUARE HOLE
 GM-'95 & UP
 UNIT PKG.-25

2892

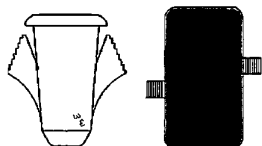

(5FR56DX9)
**PLASTIC RETAINER
 SILL MOULDING**
 JEEP-'98 & UP
 UNIT PKG.-20

HOLE SIZE-9 X 10 MM
 HEAD DIAM.-11 X 20 MM
 OVERALL LENGTH- 18 MM

3055

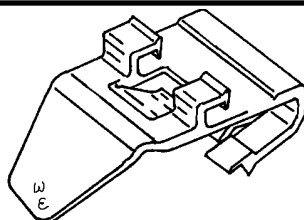

(91561-S84-A01-M1)
DOOR MOULDING RETAINER
 LIGHT BLUE
 HONDA ACCORD-'98 & UP
 UNIT PKG.-25

2960

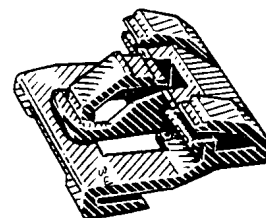

(91510-SR3-003)
BELT MOULDING CLIP
 HONDA CIVIC-'92 & UP
 UNIT PKG.-10

3039



(10287926)
**FRONT & REAR
 DOOR MOULDING CLIP**
 GM-'97 & UP
 UNIT PKG.-25

3150

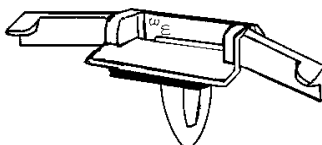

(91528-S01-A01)
(REPLACES-91528-SR4-003)
DRIP RAIL MOULDING CLIP
 HONDA-ACCORD, CIVIC
 1995 & UP
 UNIT PKG.-15

2370

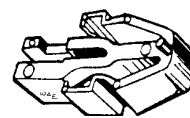

(90467-13008)
GRILLE CLIP-TOYOTA
 UNIT PKG.-10

3081



(15002520, 15682898)
RADIATOR GRILLE CLIP
 ZINC ORGANIC PLATING
 GM-SMALL PICK-UPS
 & FULL SIZE VANS-'94 & UP
 UNIT PKG.-15

2378

(90651-689-0030)
 (90651-689-9000)

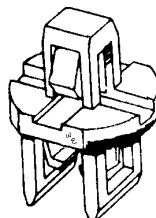

GRILLE RETAINER
 HONDA
 UNIT PKG.-10

2408

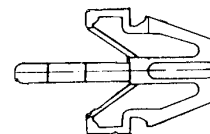

(58974-00008), (89421-80270)
**GRILLE CLIP- MITSUBISHI,
 ISUZU,
 HONDA, MAZDA,FORD-ESCORT**
 UNIT PKG.-20

DOOR MOULDING/ GRILLE CLIPS

2195



(003-988-1978)
**PLASTIC RETAINER
 GRILLE MOULDING
 MERCEDES-BENZ
 UNIT PKG.-50**

2196

(003-988-2078)

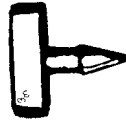

**PLASTIC RETAINER
 GRILLE MOULDING
 MERCEDES-BENZ
 (LARGER THAN W&E #2195)
 UNIT PKG.-50**

2175

(25501771)



**METAL SCREW RETAINER
 (STAINLESS STEEL)
 FOR HEADLAMP PANEL
 OLDS- '80 & UP
 UNIT PKG.- 50**

2368

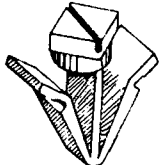

(62318-01W00)
**GRILLE RETAINER
 NISSAN-(GREY)
 UNIT PKG.-10**

2369

(62318-H8500)

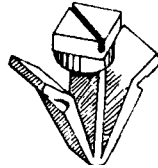

**GRILLE RETAINER
 NISSAN-(BLACK)
 UNIT PKG.-10**

2300



(171-853-695A)
**PLASTIC GRILLE CLIP- VW
 UNIT PKG.-25**

2578

(90467-17004)

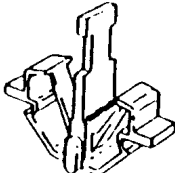

**PLASTIC GRILLE CLIP
 TOYOTA- '84 & UP
 UNIT PKG.-15**

2608

(91635-SM4-003)

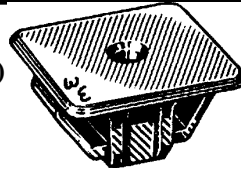

**HEADLAMP TO GRILLE SPACER
 HONDA ACCORD-'90 & UP
 UNIT PKG.-10**

SCREW SIZE-5 MM

2651

(55055098)



**HEADLAMP GRILLE RETAINER
 DODGE TRUCKS
 UNIT PKG.-50**

HOLE SIZE-3.5 MM
 HEAD DIAM.-11 MM

3269



(87756-3D000)
**PLASTIC SIDE MOULDING
 RETAINER WITH SEALER
 HYUNDAI- 2002 & UP
 KIA- 2004 & UP
 UNIT PKG.- 15**

FOR 4.2 MM (#8) SCREW
 14 MM SQUARE HEAD
 OVERALL HEIGHT-11 MM

3350

(75315-S9A-004;
 REPL.75315-STK-A01)



**PLASTIC RETAINER FRONT &
 REAR DOOR MOULDING
 HONDA CRV & ACURA RDX
 2007 & UP
 UNIT PKG.-15**

TOP HEAD 12 X 15 MM
 O/A HEIGHT- 15.2 MM

3351

(75316-S9A-004)



**PLASTIC RETAINER FRONT &
 REAR DOOR MOULDINGS
 HONDA CRV & ACURA RDX
 2007 & UP
 UNIT PKG.-15**



FOR 10 MM HOLE
 14 X 16 MM HEAD

3397

(68213168AA)
**GRILLE RETAINER
 (20 MM MIDDLE FLANGE DIAM.;
 31 MM OVERALL LENGTH)
 DODGE RAM 1500- 2013 & UP
 UNIT PKG.- 10**

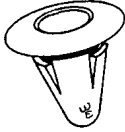
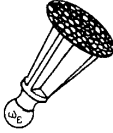

GRILLE/ COWL CLIPS

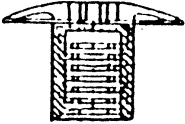
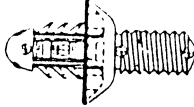
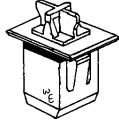
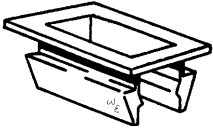
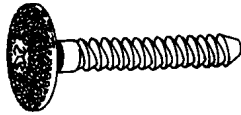
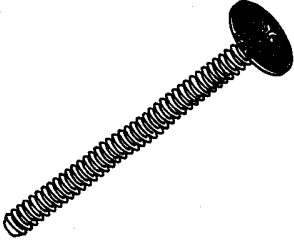
<p>3060</p>  <p>USE WITH W&E #3061 (90467-08184) COWL VENT GROMMET TOYOTA 4 RUNNER, PRE-RUNNER, TACOMA & TUNDRA- '95 & UP UNIT PKG.-15</p> <div style="border: 1px solid black; padding: 2px; width: fit-content; margin: 0 auto;">HEAD O.D.-13 MM STEM LENGTH-15 MM</div>	<p>3061 (90467-07045-22)</p>  <p>USE WITH W&E #3060 COWL VENT PIN TOYOTA-4 /PRE RUNNER, TACOMA & TUNDRA-'95 & UP UNIT PKG.-15</p> <div style="border: 1px solid black; padding: 2px; width: fit-content; margin: 0 auto;">HEAD O.D.-13 MM STEM LENGTH-15 MM</div>	<p>2598</p>  <p>(91501-SM4-003) COWL TOP RETAINER HONDA ACCORD-'90 & UP UNIT PKG.-15</p> <div style="border: 1px solid black; padding: 2px; width: fit-content; margin: 0 auto;">HD.DIAM.-14 MM</div>
<p>2650</p>  <p>(6503339) COWL SCREEN STUD CAP T30 TORX DRIVE (USE WITH W&E #2649) DODGE TRUCKS UNIT PKG.- 20</p> <div style="border: 1px solid black; padding: 2px; width: fit-content; margin: 0 auto;">HEAD DIAMETER-21 MM</div>	<p>2649</p>  <p>(6503336) COWL SCREEN STUD (USE WITH W&E # 2650) DODGE TRUCKS UNIT PKG.-25</p> <div style="border: 1px solid black; padding: 2px; width: fit-content; margin: 0 auto;">HOLE SIZE-1/4"</div>	<p>3082</p>  <p>(90157-SPO-901) PLASTIC GRILLE RETAINER HONDA-ODYSSEY-'95 & UP ACURA-'91 & UP UNIT PKG.-10</p> <div style="border: 1px solid black; padding: 2px; width: fit-content; margin: 0 auto;">HOLE SIZE-8 MM SQUARE FLANGE--10 X 14 MM OVERALL HEIGHT- 15 MM</div>
<p>2935</p>  <p>(F7DB-5402316-AA) (W7016505; F6DZ-5402316-AA)</p> <p>COWL TOP VENT GRILLE GROMMET FOR 9 X 12 MM HOLE USE WITH W&E #2936 OR #2937 FORD TAURUS/SABLE-'96 & UP UNIT PKG.-50</p> <div style="border: 1px solid black; padding: 2px; width: fit-content; margin: 0 auto;">HD.DIAM.-14 MM LENGTH- 25 MM</div>	<p>2936</p>  <p>(W704881-S300; W701649-S)</p> <p>PHILLIPS HEAD NYLON COWL VENT SCREW (USE WITH W&E # 2935) FORD TAURUS/SABLE-'96 & UP UNIT PKG.-25</p> <div style="border: 1px solid black; padding: 2px; width: fit-content; margin: 0 auto;">HD.DIAM.-14 MM LENGTH- 25 MM</div>	<p>2937</p>  <p>(N811849-S300) (PICTURE -NOT ACTUAL SIZE) PHIL. HD NYLON COWL VENT SCREW (USE WITH W&E # 2935) FORD TRUCKS/ LINCOLN TOWN CAR- '98 & UP UNIT PKG.-15</p> <div style="border: 1px solid black; padding: 2px; width: fit-content; margin: 0 auto;">HD.DIAM.-14 MM, LENGTH- 52 MM</div>

COWL/ BUMPER CLIPS

3091

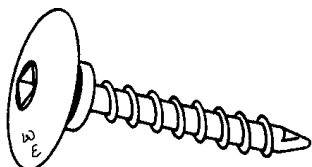

(CHRY 6503401,6503819);
(GM 25631448)
PLASTIC SCREW-7.5 X 34 MM
SQUARE DRIVE- TRUSS HEAD
HOLDS FOAM TO BUMPER FASCIA
GM & CHRYSLER-'93 & UP-BLACK
UNIT PKG.-15

HOLE SIZE-7.5 MM
HEAD DIAM.-22 MM
LENGTH UNDER HD-34 MM
SHOULDER DIAM. -9 MM

2968

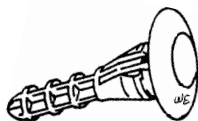

(90108-SW3-003)
BUMPER RETAINER
HONDA/ACURA-ACCORD,
PRELUDE & ODYSSEY
'95 & UP
UNIT PKG.-10

HOLE SIZE-6 MM
HEAD DIAM.-16 MM
OVERALL HEIGHT-23 MM

3204

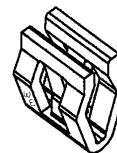

(11561857)
PLASTIC BUMPER
MOULDING CLIP
GM- 2007
CADILLAC ESCALADE,
GMC YUKON, CHEVY
SUBURBAN & TAHOE
UNIT PKG.-25

3173

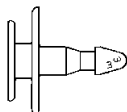

(90602-SXO-0030)
PLASTIC COWL VENT
RETAINER
HONDA/ACURA 1995 & UP
USE WITH W&E-#3174
UNIT PKG.-15

UPPER HD DIAM.-12 MM
OVERALL LENGTH-18 MM

3174



(90603-SXO-0030)
PLASTIC COWL VENT
GROMMET WITH SEALER
HONDA/ACURA-'95 & UP
USE WITH W&E- #3173
UNIT PKG.-15

HOLE SIZE-6 X 20 MM
HEAD DIAM.-14 X-28 MM

2372



(90676-671-0030)
BUMPER RETAINER
SPLASH SHIELD
FRONT & REAR
HONDA
UNIT PKG.-15

2384

(OE-1304967)

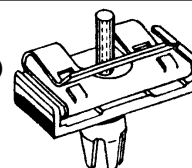

PLASTIC BUMPER COVER
MOULDING CLIP
FRONT & REAR
VOLVO-'83 & UP
UNIT PKG.-10

3177



(90603-S7S-0030)
PLASTIC COWL VENT GROMMET
WITH SEALER
HONDA/ ACURA-2003 & UP
USE WITH W&E- #3176
UNIT PKG.-10

HOLE SIZE-6 X 20 MM
HEAD DIAM.-10 X-24 MM

3176



(90602-S7S-0030)
PLASTIC COWL VENT
RETAINER
HONDA/ACURA-2003 & UP
USE WITH W&E- #3177
UNIT PKG.-20

UPPER HD DIAM.-12 MM
OVERALL LENGTH-11 MM

3387



(91501-SL4-003)
PLASTIC COWL VENT
RETAINER
(HOLE SIZE 6 MM; HD DIAM.
13 MM; O/A LENGTH 11 MM)
HONDA/ACURA:ACCORD, CIV-
IC,ODYSSEY, CR-V; RL & RDX-
2003 & UP
UNIT PKG.-25

BUMPER/GRILLE/ROCKER MOULDING RETAINERS

3185

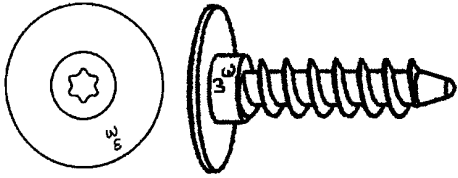

(06507866AA)
BUMPER COVER RETAINER
 (T25 TORX)
 DODGE DURANGO 2004-2006
 BLACK NYLON
 UNIT PKG.-25

HEAD DIAM.-22 MM, LENGTH-36.5 MM

3131

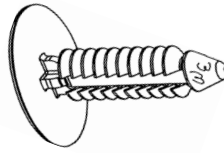

(W708035-S300)
REAR BUMPER
COVER RETAINER
 (USE WITH W&E#3130)
 FORD EXPEDITION-
 2003 & UP
 UNIT PKG.-25

HOLE SIZE-7 MM
 HD.DIAM.-21 MM
 STEM LENGTH-25 MM

3130

(W709629-S300)
 (W708045-S300)

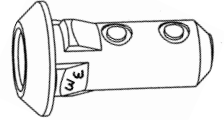

REAR BUMPER COVER
GROMMET
 (USE WITH W&E#3131)
 FORD EXPEDITION
 2003 & UP
 UNIT PKG.-25

HOLE SIZE-9.5 MM
 HD.DIAM.-15 MM
 OVERALL HEIGHT-25 MM

3294



(52575-30180)
PLASTIC REAR BUMPER
COVER RETAINER
 TOYOTA - LEXUS GS SERIES
 2006 & UP

UNIT PKG.- 10

OUTSIDE DIMENSIONS-17 X 18 MM

3262



(75392-35200)
 (REPLACES-75392-04010)
BUMPER COVER, SPOILER
& FENDER FLARE RETAINER
 TOYOTA-CAMRY, TACOMA,
 FJ CRUISER & RAV 4
 2005 & UP
 UNIT PKG.- 15

HOLE SIZE-4.5 X 16 MM
 13 X 26 MM HEAD
 OVERALL HEIGHT- 27 MM

3191

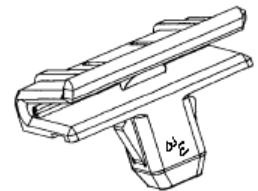

(90084-46020)
PLASTIC FRONT BUMPER
STRIP RETAINER
 TOYOTA CAMRY AND
 AVALON -2000-2006

UNIT PKG.-10

HOLE SIZE-9 MM (SQUARE)
 HEAD -23 MM X 30 MM
 OVERALL HEIGHT-19 MM

3360

(25744385)



PLASTIC ROCKER
MOULDING RETAINER
 (FOR 9 MM HOLE; 23 X 46 MM HEAD)
 GM-CADILLAC CTS, CTS WAGON
 & CTS COUPE- 2011 & UP
 UNIT PKG.-15

3389



(91503-T2A-A01)
PLASTIC BELT
MOULDING RETAINER
 (20 MM WIDE X 29 MM LONG)
 HONDA ACCORD-2013-UP
 UNIT PKG.-25

3393

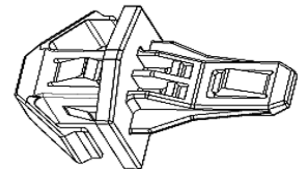

(Picture not actual size)
 (91578-SW5-003;91578-T0A-003)
PLASTIC GRILLE RETAINER
 (O/A LENGTH- 41 MM;
 CENTER PLATE-19x24 MM)

HONDA/ACURA: CR-V/TL-1998-UP

UNIT PKG.-15

ROCKER PANEL MOULDING CLIPS

2109



(OE- 3986976)
**ROCKER PANEL MOULDING
 FASTENER GM PRODUCTS
 '71-'78**

UNIT PKG.-25

2755

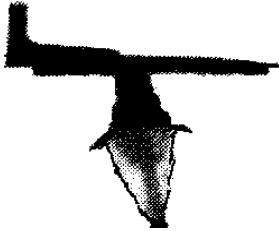

(OE-N/A)
**MOULDING RETAINER
 ROCKER PANEL
 TOYOTA CAMRY**

UNIT PKG.-5

3035

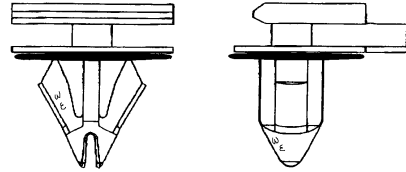

(11518357)
**PLASTIC ROCKER PANEL
 MOULDING CLIP WITH SEALER
 GM- CHEV. AVALANCHE-2002
 UNIT PKG.-15**

**HOLE SIZE-9 MM
 TOP HEAD DIAM.-14 X 20 MM
 OVERALL HEIGHT-20 MM**

3036

(25722671)

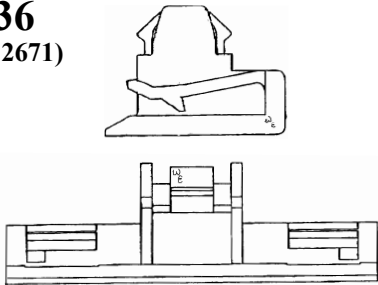

**PLASTIC ROCKER PANEL
 MOULDING CLIP
 2002 GM: CADILLAC, PONTIAC,
 OLDSMOBILE & BUICK
 UNIT PKG.-10**

**WIDTH-7/8"
 OVERALL DIAM.-2"**

3042

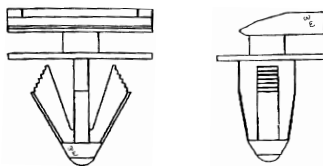

(10423553)
**PLASTIC ROCKER
 MOULDING RETAINER
 GM-2002 PONTIAC & CHEVY
 UNIT PKG.-15**

**HOLE SIZE-8 MM
 TOP HEAD DIAM.-12 X 20 MM
 BOTTOM HEAD-15 X 20 MM
 OVERALL HEIGHT-21 MM**

3043

(25724529)

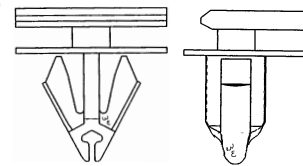

**PLASTIC ROCKER PANEL
 MOULDING CLIP-NATURAL
 GM 2002**

UNIT PKG.-15

**HOLE SIZE-8 MM
 TOP HEAD DIAM.-14 X 20 MM
 BOTTOM HEAD-16 X 20 MM
 OVERALL HEIGHT-29 MM**

3044

(22603384)

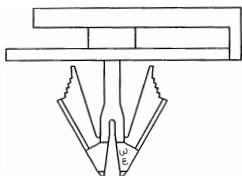

**PLASTIC ROCKER PANEL MOULDING CLIP-
 NATURAL; GM-'99 & UP
 UNIT PKG.-15**

**HOLE SIZE-8 MM, TOP HEAD DIAM.- 19 X 26 MM
 LOWER HEAD-19 X 30 MM
 OVERALL HEIGHT-22.4 MM**

3049

(10411395;10431761)

**PLASTIC ROCKER
 MOULDING CLIP
 CHEVY MONTE CARLO & IMP.
 2000 & UP
 UNIT PKG.-15**

**HOLE SIZE-7/16"
 TOP HEAD DIAM.-11/16" X 1-1/2"
 OVERALL HEIGHT-1-37/64"**

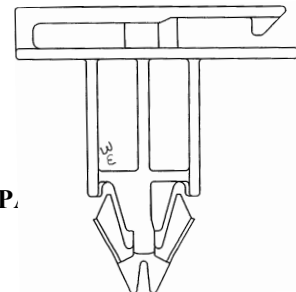

ROCKER PANEL MOULDING CLIPS

3074

(91513-SM4-000)

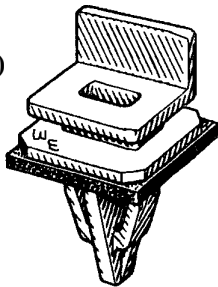

**ROCKER PANEL MOULDING
RETAINER W/SEALER
HONDA ACCORD & CIVIC
ACURA-'90 & UP
UNIT PKG.-10**

HOLE SIZE-12 MM
HEAD DIAM.-20 MM X 20 MM

3108

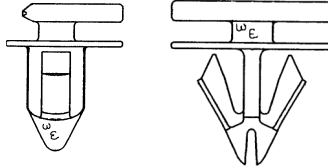

(25693852)
**PLASTIC ROCKER PANEL
MOULDING RETAINER
GM-'95 & UP
UNIT PKG.-25**

HOLE SIZE-9 MM
TOP HEAD DIAM.-14 X 20 MM
OVERALL HEIGHT-20 MM

3116



(PICTURE NOT ACTUAL SIZE)
(10352799)
(REPLACES-10431524)
**PLASTIC ROCKER PANEL
MOULDING RETAINER
CHEVY-'2000 & UP**

UNIT PKG.-15

HOLE SIZE-7 MM
HEAD DIAM.-17 X 33 MM
OVERALL HEIGHT-20 MM

3129



(PICTURE NOT ACTUAL SIZE)
(10352803)
(REPLACES-10437565)
**PLASTIC ROCKER PANEL
MOULDING RETAINER
CHEVY-'2000 & UP
UNIT PKG.-10**

HOLE SIZE-7 MM
HEAD DIAM.-12 X 33 MM
OVERALL HEIGHT-20 MM

3265



(87758-3D000)
**PLASTIC DOOR AND
ROCKER PANEL MOULDING
CLIP WITH SEALER
HYUNDAI- 2002 & UP;
KIA- 2004 & UP
UNIT PKG.- 15**

TOP HEAD DIAM.-16 X 20 MM
OVERALL HEIGHT-15 MM

3266



(87756-38000)
**PLASTIC DOOR AND
ROCKER PANEL MOULDING
CLIP WITH SEALER
HYUNDAI- 1995 & UP
KIA- 2001 & UP**

UNIT PKG.- 15

TOP HEAD DIAM.-8 X 9 MM
OVERALL HEIGHT-15 MM

3276

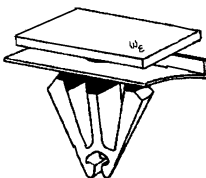

(10323057)
**PLASTIC ROCKER
PANEL RETAINER
GM-BUICK, CHEVROLET
PONTIAC AND SATURN
UNIT PKG.- 15**

FOR 9 MM HOLE
TOP HEAD DIAM.-12 X 20 MM
OVERALL LENGTH-15 MM

3278

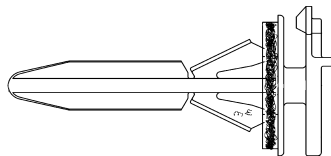

(11589244; REPL.-11569973)
**PLASTIC RETAINER WITH
SEALER; ROCKER PANEL &
REAR MOULDING
GM-CHEVY & GMC-'02-'07
UNIT PKG.- 10**

FOR 9 MM HOLE
TOP HEAD DIAM.-12 X 21 MM
OVERALL LENGTH-43 MM

3280



(PICTURE NOT ACTUAL SIZE)
(11518988; REPL.-11609303)
**PLASTIC RETAINER
WITH SEALER
ROCKER PANEL MOULDING
GM/GMC SMALL TRUCKS &
HUMMER-2002 & UP
UNIT PKG.- 15**

FOR 9 MM HOLE
TOP HEAD DIAM.-12 X 21 MM
OVERALL LENGTH-22 MM

3358



(25796285)
**PLASTIC DRIP
MOULDING
RETAINER W/ SEALER
GM-CADILLAC CTS
2008 & UP
UNIT PKG.-15**

HOLE SIZE 7 MM
TOP HEAD 7 X 15 MM
BOTTOM HEAD 13 X 26 MM

ROCKER PANEL MOULDING/ FENDER/ WHEELHOUSE CLIPS

3282

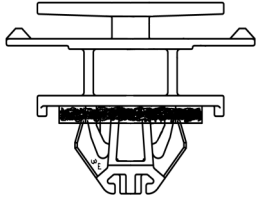

(15872008; REPLACES-11561491)
PLASTIC RETAINER WITH SEALER
ROCKER PANEL MOULDING
GM-CHEVY EQUINOX
PONTIAC TORRENT
2006 & UP
UNIT PKG.- 10

FOR 9 MM HOLE
 TOP HEAD DIAM.-20 X 30 MM
 OVERALL LENGTH-28 MM

3286

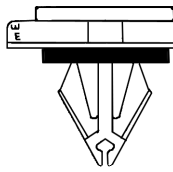

(11609923)
PLASTIC ROCKER MOULDING
RETAINER WITH SEALER
GM-PONTIAC G6
CHEVY CAMARO
2006 & UP
UNIT PKG.- 10

FOR 9 MM HOLE
 TOP HEAD DIAM.-12 X 20 MM
 OVERALL HEIGHT-21 MM

3309

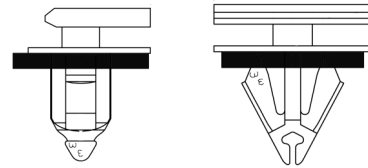

(5480852)
PLASTIC ROCKER PANEL
MOULDING RETAINER
WITH SEALER
GM-CHEVY EQUINOX
PONTIAC TORRENT
2005 & UP
UNIT PKG.-10

FOR 9 MM HOLE
 TOP HEAD DIAM.-14 X 20MM
 OVERALL HEIGHT-21 MM

3310

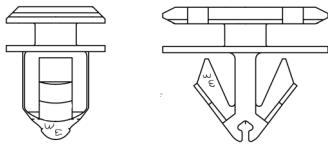

(15127746)
PLASTIC MOULDING RETAINER
FENDER, LIFT GATE
GM-CHEVY, PONTIAC, BUICK,
GMC- 2005 & UP
UNIT PKG.-15

FOR 9 MM HOLE
 TOP HEAD DIAM.-12 X 20 MM
 OVERALL HEIGHT-17 MM

3312

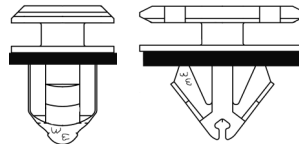

(11562250)
ROCKER PANEL, SIDE
MOULDING RETAINER
WITH SEALER
INT. SEAT APPLIQUE
GM-SATURN- 2005 & UP
NATURAL PLASTIC
UNIT PKG.-15

FOR 9 MM HOLE
 TOP HEAD DIAM.-12 X 20 MM
 OVERALL HEIGHT-16 MM

3313

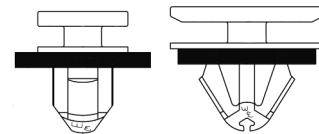

(11571175)
ROCKER PANEL
MOULDING RETAINER
WITH SEALER
GM-SATURN, CADILLAC, GMC
2005 & UP
ORANGE PLASTIC
UNIT PKG.-15

FOR 9 MM HOLE
 TOP HEAD DIAM.-12 X 20 MM
 OVERALL HEIGHT-16 MM

3322

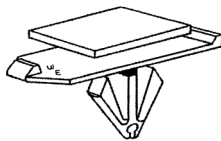

(11562563)
PLASTIC ROCKER PANEL
MOULDING RETAINER
GM-CHEVY MALIBU 2008 & UP
UNIT PKG.-15

FOR 9 MM HOLE
 TOP HEAD DIAM.-12 X 32 MM
 OVERALL HEIGHT-15 MM

3325

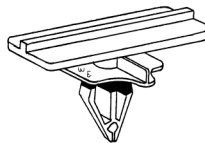

(W709767-S300; REPL. F57Z-16241-AB)
PLASTIC ROCKER PANEL
MOULDING RETAINER
FORD MUSTANG 2001 & UP
UNIT PKG.-15

FOR 9 MM HOLE
 TOP HEAD DIAM.-14 X 40 MM
 OVERALL HEIGHT-19 MM

3348

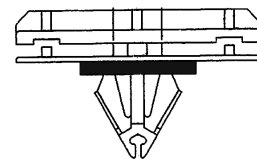

(55157055-AA; 55157065-AA)
PLASTIC FRONT & REAR
FENDER MOULDING
RETAINER WITH SEALER
JEEP LIBERTY-2002-UP
UNIT PKG.-15

FOR 9 MM HOLE
 TOP HEAD DIAM.-14 X 38 MM
 STEM LENGTH-15 MM

ROCKER PANEL MOULDING/ FENDER/ DOOR PANEL

3388



(76222-SP1-003)

**PLASTIC MOULDING RETAINER
W/SEALER-FOR BODY SIDE,
ROOF, FENDER & SILL**
(FOR 6 MM HOLE; 13 X 14 MM TOP
HEAD; 8 MM STEM LENGTH)

**HONDA/ACURA- 1991-UP
VARIOUS MODELS**

UNIT PKG.-25

3390



(91504-SP1-003)

**PLASTIC MOULDING CLIP W/
SEALER-FENDER & ROCKER**
(FOR 10 MM HOLE; 12 X 16 MM TOP
HEAD; 15 MM STEM LENGTH)

**HONDA/ACURA:
CR-V, ODYSSEY/RDX, TL
2007-UP**

UNIT PKG.-25

3391



(91512-S50-003)

**PLASTIC ROCKER MOULDING
RETAINER WITH SEALER**
(FOR 10 MM HOLE; 12 X 16 MM
TOP HEAD; 12 MM STEM
LENGTH)

**ACURA- MDX
2007-2013**

UNIT PKG.-10

3394

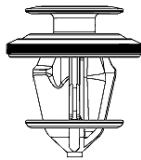

(67773-0E020)

**DOOR PANEL RETAINER
WITH SEAL**
FRONT & REAR DOORS
(FOR 8.5 MM HOLE; 13 MM TOP
HD O.D; 18 MM LOWER HD
O.D; 20 MM O/A LENGTH)

**TOYOTA AVALON, CAMRY,
COROLLA & SIENNA- 2012-UP
UNIT PKG.-25**

3395

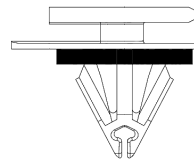

(11610495)

**ROCKER MOULDING
RETAINER WITH SEALER**

(FOR 9 MM HOLE; 12 X 24 MM
LARGE HD; 15 MM STEM
LENGTH)

**GM-CHEVY CAMARO
2010-UP**

UNIT PKG.-15

3399

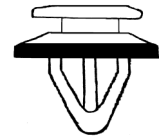

(90913-0088)

**PLASTIC RETAINER
WITH SEALER**
**FENDER FLARE, FENDER
MLDNG & ROCKER MLDNG**
(FOR 9 MM HOLE; 18 MM
OVERALL LENGTH)

**SUBARU- FORESTER, LEGA-
CY, OUTBACK, IMPREZA &
B9 TRIBECA
2006-UP**

UNIT PKG.-20

3405



(11569920)

PLASTIC MOULDING RETAINER
HOOD AND FENDER
(FOR 9 MM HOLE; 8 X 11 MM TOP
HEAD; 13 MM STEM LENGTH)

**GM- BUICK, CADILLAC &
CHEVY- 2010-UP**

UNIT PKG.-10

3406

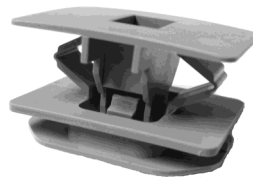

(W716350-S300)

PLASTIC MOULDING RETAINER
ROCKER PANEL
(FOR 9 X 20 MM HOLE;
23 X 30 MM TOP HEAD)

**FORD-FUSION, LINCOLN-MKZ
2013-UP**

UNIT PKG.-10

3407



(W716503-S300)

PLASTIC MOULDING RETAINER
ROCKER PANEL
(FOR 9 X 14 MM HOLE; 20 X 21 MM
TOP HEAD; 14 MM STEM LENGTH)

**FORD-FUSION, LINCOLN-MKZ
2013-UP**

UNIT PKG.-25

GROMMETS/INTERIOR TRIM/COWL GRILLE

3380



(90189-04207)

**PLASTIC SCREW GROMMET
WHEEL WELL LINER AND
SIDE MOULDING
FOR #4(M2.9) SCREW
(FITS 7 MM SQ. HOLE; 9 MM
SQ.HEAD; 15 MM O/A HEIGHT)
TOYOTA/LEXUS
1998-UP**

UNIT PKG.-20

3381

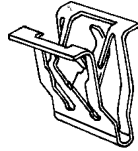

(11589329)

**RETAINER-INTERIOR TRIM,
OVERHEAD CONSOLE AND
SILL PLATE
(6 X 21 MM HOLE; 12 MM WIDE;
16 MM LONG)
GM, GMC, BUICK,
CADILLAC & CHEVY
2007-UP**

UNIT PKG.-25

3386

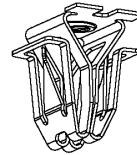

(11609651)

**INTERIOR TRIM PANEL &
MOULDING RETAINER
(4.2 MM (#8) SCREW; 13.2 X 20.5
MM HEAD; 22 MM O/A LENGTH)
GM, BUICK, CADILLAC
CHEVY & GMC MODELS/SUV'S
ZINC PLATED- 2008-UP**

UNIT PKG.-15

3383



(11610086, 22547243, 6501916)

**RETAINER-FRONT AIR SHIELD,
COWL GRILLE & INT. TRIM
(6.3 MM HOLE; 22 MM HD DIAM.;
30 MM O/A LENGTH)
GM, BUICK, OLDS
CADILLAC & CHEVY-1995-UP
CHRYSLER, MINIVAN, JEEP, &
DODGE-RAM- 2008-UP**

UNIT PKG.-50

3396

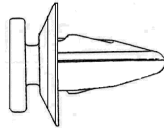

(MR181745)

**PLASTIC RETAINER
SCUFF PLATE & INT. TRIM
(FOR 7 MM HOLE; 12 MM TOP
HD DIAM.;16 MM LOWER
FLANGE DIAM.; 19MM O/L)
CHRYSLER-SEBRING
DODGE- STRATUS
MITSUBISHI- LANCER &
OUTLANDER SPORT
2001-UP**

UNIT PKG.-25

3400

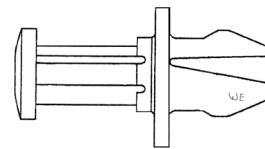

(6509761AA; Repl.68053681AA)

**PLASTIC PUSH RIVET
FASCIA & AIR DAM
TO BUMPER
(FOR 10 MM HOLE; 20 MM
HEAD DIAM.; 13 MM STEM
LENGTH)**

**DODGE/CHRYSLER
RAM PICK UPS
2013-UP
UNIT PKG.-15**

3403



(11562568)

**PLASTIC INTERIOR TRIM
PANEL RETAINER
(FOR 9 MM HOLE; 20 MM HEAD
DIAM.; 19 MM STEM LENGTH)
GM- BUICK, CADILLAC, CHEVY
& GMC-2007-UP**

UNIT PKG.-10

3404



(W708633-S300)

**HOOD INSULATION &
SPLASH SHIELD
RETAINER- BLACK
(FOR 6.3 MM HOLE; 31 MM
HEAD DIAM.; 12.5 MM
STEM LENGTH)
FORD- F-150 & FUSION
MERCURY MILAN; LINCOLN
MKZ & ZEPHYR-2010-UP
UNIT PKG.-25**

3408



(W716510-S300)

**PLASTIC PUSH RIVET- LOWER
ENGINE SHIELD, COWL,
& FENDER LINER
(FOR 9 MM HOLE; 18 MM FLANGE
DIAM.; 28 MM O/A LENGTH)
FORD & LINCOLN
2013-UP
UNIT PKG.-10**

BUMPER/FENDER/GRILLE/MOULDING

3409



(11610157)
RETAINER WITH SEAL-
BUMPER COVER, GRILLE &
INTERIOR DASHBOARD
 (TAKES #8(4.2) SCREW; 9/16" SQ.
 HEAD; 33/64" O/A LENGTH)
GM- BUICK, CADILLAC, CHEVY
& GMC- 2003-UP

UNIT PKG.-10

3410



(15078238)
BUMPER COVER -
GRILLE RETAINER
 (1" X 5/8" HEAD; 5/8" O/A HEIGHT)
CHEVY/GMC - FULL SIZE VANS
& TRUCKS
1999-UP

UNIT PKG.-15

3411

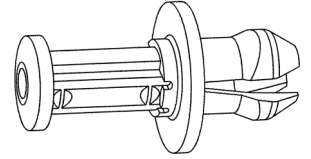

(W714584-S300)
PLASTIC PUSH RIVET-
GRILLE RETAINER
 (FOR 10MM HOLE; 20MM HEAD
 DIAM.; 16MM STEM LENGTH)
FORD- "F" SERIES PICK-UPS
2011-UP

UNIT PKG.-25

3412

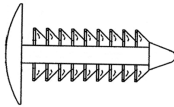

(10098645; 390964-S)
BLACK PLASTIC RETAINER -
INTERIOR & EXTERIOR TRIM;
WEATHERSTRIP &
BUMPER COVER
 (FOR 7/32" HOLE; 1/2" HD. DIAM.;
 55/64" O/A LENGTH)
GM & FORD
1994-UP

UNIT PKG.-50

3413

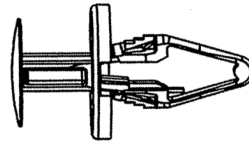

(11589292)
BLACK PLASTIC PUSH RIVET-
BUMPER, FENDER LINER,
GRILLE & AIR DAM
 (FOR 8.5 MM HOLE; 20 MM HEAD
 DIAM.; 20 MM STEM LENGTH)
VARIOUS GM & PICKUPS
2006-UP

UNIT PKG.-25

3414

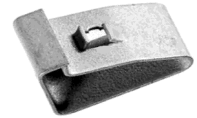

(4806226-AA; 11562364)
METAL RETAINER - GRILLE,
BUMPER COVER & SKID PLATE
 (FOR #6 SCREW; 10 MM WIDE X 18 MM
 LONG)
ZINC PLATED
 (500HR.SALT SPRAY TOL.)
CHRYSLER-300, DODGE-NITRO/
CHARGER, JEEP COMMANDO,
GM, BUICK, CHEV.-P/U/SUV'S,
CAMARO, & CORVETTE
2005-UP

UNIT PKG.-15

3415



(W716460-S300)
PLASTIC MOULDING
RETAINER- BUMPER COVER
& MUD GUARD RETAINER
 (FOR 5 X 12 MM SLOT; 11 X 20
 MM HEAD; 13.5 MM O/A HEIGHT)
FORD & LINCOLN
2011-UP

UNIT PKG.-25

3417



(15120856; REPL.
10273233,11589330)
PLASTIC PUSH RIVET
INT. LOCK PILLAR TRIM;
LIFTGATE TRIM
 (18 MM HEAD DIAM.;
 20 MM PIN LENGTH)
GM-C/K PICKUP; 1500 PICKUP
& CADILLAC ESCALADE
HYBRID-2008-UP
UNIT PKG.-25

3419



(W716351-S300)
PLASTIC RETAINER
WHEEL OPENING MOULDING
 (FOR 9 MM HOLE; 12 X 20 MM TOP
 HD; 19 MM O/A HEIGHT)
FORD ESCAPE &
LINCOLN MKC
2013-UP

UNIT PKG.-25

BUMPER/FENDER/GRILLE/MOULDING

3420



(GM 11547341; CHRYS/JEEP
68225214AA)
**RETAINER- FRONT EMBLEM;
GRILLE & MOULDING**
(FOR 6.5 MM SLOT; 12 X 21 MM
HEAD; 19 MM O/A HEIGHT)
**GM-CADILLAC-ELR; CHEVY-
CRUZE & IMPALA; JEEP-
CHEROKEE-2014-UP**

UNIT PKG.-25

3421

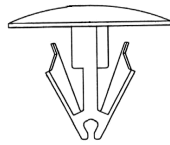

(11546805)
RETAINER- FENDER LINER
(FOR 7 MM HOLE; 20 MM HD
DIAM.; 18 MM O/A HEIGHT)
**CHEVY/GMC- COLORADO
& CANYON PICKUP**
2015-UP

UNIT PKG.-50

3423

(24501057)



**RETAINER- FENDER LINER;
HEAT SHIELD; RADIATOR
BAFFEL**
(5/16"(8 MM) HOLE; 1" HD DIAM.;
7/8" O/A LENGTH)
GM/GMC
**CADILLAC-DEVILLE, ESCALADE,
CFS; YUKON, SUBURBAN; CHEVY-
COLORADO & CANYON P/U-**
2000-UP
UNIT PKG.-25

3425



(N803739-S)
**BLACK NYLON BLIND
SEALING RIVET**
(HOLE DIAM. 6.3 MM(1/4"); PANEL
RANGE 0.70-2MM(1/32-5/64");
HEAD DIAM. 18 MM(45/64")
**FORD TRUCKS & VANS,
MERCURY TOPAZ &
MOUNTAINEER**
1988-2014
UNIT PKG.-25

3426



(91513-SJK-003)
**PLASTIC MOULDING RETAINER
WITH SEALER- ROCKER,
PILLAR, SPOILER, & TAILGATE**
(FOR 8.5 MM HOLE; 20 MM
HEAD FLANGE DIAM.;
13 MM STEM LENGTH)
**HONDA-ACCORD, CR-V
CIVIC,ELEMENT, & PILOT;
ACURA- MDX, RDX, RLX & TSA**
2007-UP
UNIT PKG.-15

3427

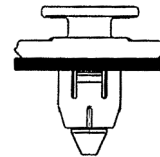

(91512-STK-A01)
**PLASTIC MOULDING RETAINER
WITH SEALER**
TAILGATE MOULDING
(FOR 8.5 MM HOLE; 13 MM TOP
HEAD; 20 MM FLANGE; 20 MM
OVERALL LENGTH)
**HONDA-CR-V, ACCORD, ODYSSEY
ACURA- RDX & TSX**
2011-UP
UNIT PKG.-10

3428



(W717736-S300)
**PLASTIC WHEEL OPENING
MOULDING RETAINER**
(FOR 9 MM HOLE; TOP HEAD 14X20
MM; BOTTOM HEAD 14X18 MM;
25 MM OVERALL LENGTH)
FORD F-150
2015-UP
UNIT PKG.-10

3429

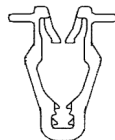

(90601-SMG-003)
**PLASTIC BUMPER COVER
RETAINER**
(FOR 7X13 MM HOLE; 13X18 MM
OVERALL DIMENSIONS)
HONDA CR-V
2015-UP
UNIT PKG.-25

3430

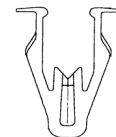

(90666-SDA-A01)
**PLASTIC RETAINER
GRILLE & INTERIOR TRIM**
(FOR 7X13 MM HOLE; 11X17 MM
OVERALL DIMENSIONS)
HONDA-ACCORD, CIVIC & CR-V
2003-UP
UNIT PKG.-25

FENDER/WHEELHOUSE CLIPS

2495

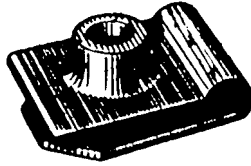

(53879-22010)
BLACK NYLON "U" NUT
 (28.5 MM LONG X 19 MM WIDE)
 TAKES #14 SCREW
 FENDER, WHEELHOUSE
 TOYOTA
 UNIT PKG.-15

2496



(53879-14010A,-14020,-22030;
 94840226; LA0156135)
BLACK NYLON "U" NUT
 31 MM LONG X 20 MM WIDE
 #10 SCREW; FNDR WHEELHOUSE
 TOYOTA, GM, & MAZDA
 UNIT PKG.-10

2582

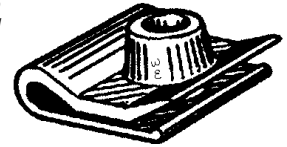

(63848-D0100)
BLACK NYLON "U" NUT
 21 MM LONG X 20 MM WIDE
 TAKES #12 SCREW
 FENDER, WHEELHOUSE
 NISSAN
 UNIT PKG.-15

2894

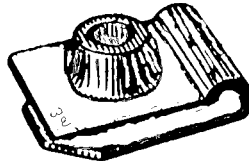

(90467-04009)
NATURAL NYLON "U" NUT
 30 MM LONG X 18 MM WIDE
 (WIDER PANEL RANGE THAN
 W&E #2495)
 TOYOTA
 UNIT PKG.-10

2910

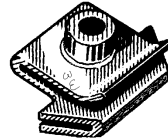

(63848-D4000)
BLACK NYLON "U" NUT
 22 MM LONG X 31 MM WIDE
 TAKES #12 SCREW
 FENDER, WHEELHOUSE
 NISSAN SENTRA
 UNIT PKG.-10

2911

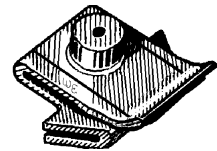

(63848-35F00)
BLACK NYLON "U" NUT
 32 MM LONG X 20 MM WIDE
 TAKES #10 SCREW
 FENDER, WHEELHOUSE
 NISSAN-MAXIMA & 240 SX
 UNIT PKG.-15

3172

(76882-OM000)
PLASTIC "U" NUT
 FENDER WHEELHOUSE
 OUTSIDE DIAM.-19 X 20 MM
 TAKES 5 MM (#10) SCREW
 NISSAN- 1995 & UP
 UNIT PKG.-25



3225

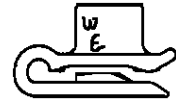

(B4555-6135)
 (REPLACES- B37F-50B11)
PLASTIC U-NUT
 BUMPER COVER &
 FRONT AIR DEFLECTOR
 TAKES 5 MM (#10) SCREW
 (OUTSIDE DIMENSIONS-
 20 X 21 MM)
 MAZDA-2003 & UP
 UNIT PKG.-25

3234



(47749-58010)
PLASTIC PIN-FRONT
 FENDER & BUMPER COVER
 TOYOTA 4 RUNNER, SOLARA,
 HIGHLANDER, & SIENNA
 LEXUS-GX 470- 2000 & UP
 (USE WITH W&E #3233 CLIP)
 UNIT PKG.-10

HEAD DIAM.-16 MM
 OVERALL LENGTH-28 MM

3233



(53879-58010)
PLASTIC RETAINER-FRONT
 FENDER & BUMPER COVER
 TOYOTA 4 RUNNER, SOLARA,
 HIGHLANDER & SIENNA
 LEXUS-GX 470-2000 & UP
 (USE WITH W&E #3234 PIN)
 UNIT PKG.-4

OUTSIDE DIMENSIONS: 25 X 35 MM

3292



(53879-16010, 53879-17020)
PLASTIC RETAINER FRONT
 BUMPER COVER & FENDER LINER
 OUTSIDE DIM.-20 MM X 27 MM
 USE WITH #10 SCREW
 TOYOTA - LEXUS-MR2,GS,LS, & IS
 SERIES - 2000 & UP
 UNIT PKG.- 15

FENDER/BUMPER/WHEELHOUSE CLIPS

3076

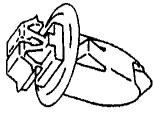

(90904-67037)
FENDER MOULDING
RETAINER-RED PLASTIC
TOYOTA TRUCKS & SUV'S
2001 & UP
UNIT PKG.-15

HOLE SIZE-9 MM SQUARE
HEAD DIAM.-17 MM
OVERALL HEIGHT-20 MM

3077

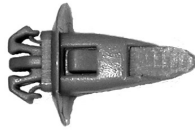

(90904-67036)
FENDER MOULDING RETAINER
BLUE PLASTIC
TOYOTA TRUCKS/SUV-2001 & UP
UNIT PKG.-15

HOLE SIZE-9 MM SQUARE
HEAD DIAM.-17 MM
OVERALL HEIGHT-24 MM

3186

(75396-35020)

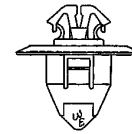

(REPLACES-75495-35010)
MOULDING RETAINER-
SIDE AND FENDER
TOYOTA, LEXUS 2003 & UP
BLUE PLASTIC
UNIT PKG.-15

HOLE SIZE-9 MM SQ. HOLE
HEAD DIAM.-17 MM
OVERALL HEIGHT-17 MM

3188

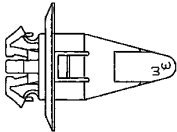

(75395-35070)
(REPLACES 75397-35010)
MOULDING RETAINER-
SIDE AND FENDER
TOYOTA, LEXUS 2003 & UP
(ORANGE PLASTIC)
UNIT PKG.-15

HOLE SIZE-9 MM SQUARE
HEAD DIAM.-17 MM
OVERALL HEIGHT-23 MM

3301

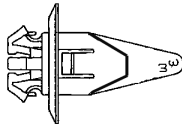

(90467-11110)
FENDER LINER FLARE
RETAINER-PLASTIC
YELLOW
TOYOTA SUV/TRUCKS-
'96 & UP
UNIT PKG.-15

HEAD DIAM.-17 MM
STEM LENGTH-17 MM
OVERALL HEIGHT- 25 MM

3267

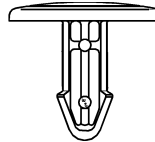

(91501-SNA-003)
(REPL.-91501-SEA-003)
FENDER LINER
TRIM RETAINER
HONDA CIVIC 2006 & UP
UNIT PKG.-15

HOLE SIZE-6 MM
HEAD DIAM.-20 MM
OVERALL HEIGHT- 19 MM

3279

(10297370)

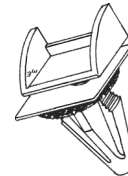

PLASTIC RETAINER WITH
SEALER- BODY
& FENDER MOULDING
GM-VANS & HUMMER
'97 & UP
UNIT PKG.-10

HOLE SIZE-9 MM
TOP HEAD SIZE-12 X 20 MM
OVERALL LENGTH-25 MM

3337



(53867-47020)
PLASTIC FRONT FENDER
RETAINER W/SEALER
TOYOTA PRIUS
'05-UP
UNIT PKG.-10

FOR 10 X 16 MM HOLE

3355



(90682-SEA-003)
PLASTIC FENDER
LINER RETAINER
HONDA & ACURA
2004 & UP
UNIT PKG.-25

SQ HOLE SIZE-9 MM
HEAD DIAM.- 20 MM
O/A LENGTH-14 MM

3349



(91502-S9A-003)
PLASTIC RETAINER W/
SEALER FRONT &
REAR BUMPER
MOULDING
HONDA CRV-2002 & UP
UNIT PKG.-10

HEAD 14 X 26 MM
O/A HEIGHT 28 MM

3384



(53857-47011)
PLASTIC FENDER SEAL CLIP
W/SEALING WASHER
TOYOTA/LEXUS
CAMRY, PRIUS, 4-RUNNER,
RAV-4, CT 200 HYBRID, GS,
GX 460 & IS 250
2010 & UP
UNIT PKG.-10

FOR HOLE SIZE-7 MM
HEAD DIAM.- 20 MM
STEM LENGTH-10 MM

FENDER/ BUMPER/ MISC. CLIPS

2809

(CHRYSLER-5183468AA
(GM-25535963)
(FORD-N811772S)

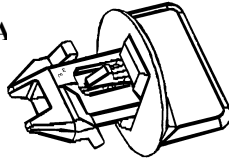

ENGINE COMPARTMENT
REAR SIDE SHIELD RETAINER
18 MM FLANGE
24.3 MM O/A LENGTH
UNIT PKG.- 25

2919

(15025531)
(15764320)

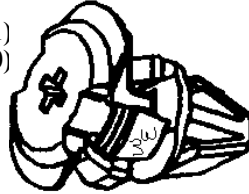

RETAINER- RADIATOR
& GRILLE- GM- C & K
TRUCKS-'99 & UP
UNIT PKG.-5

3352



(91513-SMG-E11)
PLASTIC FENDER MOULDING
RETAINER WITH SEALER
HONDA CRV & ELEMENT
2007 & UP
UNIT PKG.-20

FOR 7 MM HOLE
BOTTOM HD-DIM. 10X19 MM

2945

(15733971)

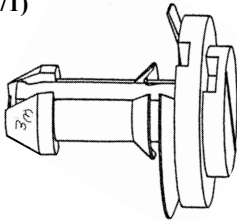

PLASTIC DRIVE RIVET BLACK
FRONT AIR DAM TO BUMPER
(USE WITH W&E # 2946)
GM-C,K TRUCKS -'99 & UP
UNIT PKG.-15

2946

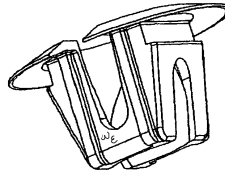

(15733970)
PLASTIC GROMMET-BLACK
FRONT AIR DAM
(USE WITH W&E #2945)
GM
UNIT PKG.-25

HOLE SIZE-14 X 16 MM
FLANGE O.D.-28 MM

3375

(63848-9Y000)



PLASTIC FENDER LINER RET.
(WIDEST WIDTH-30MM; BASE
WIDTH-20MM; O/A LENGTH 30MM)
NISSAN & INFINITY-'05 & UP
UNIT PKG.-10

3291

(53879-50020)



PLASTIC RETAINER
(USE WITH W&E #3290)
FRONT BUMPER COVER
& FENDER LINER
TOYOTA-LEXUS-GS,IS, & LS
MODELS - 2008 & UP
UNIT PKG.- 10

OUTSIDE DIMS.-25 X 35 MM

3290



(47749-50090)
PLASTIC PIN
(USE WITH W&E #3291)
FRONT BUMPER COVER &
FENDER LINER
TOYOTA - LEXUS-GS,IS, & LS
MODELS - 2008 & UP

UNIT PKG.- 20

HEAD DIAM.-10 MM
OVERALL LENGTH-26 MM

3418



(53879-30040)
PLASTIC RETAINER - FRONT
BMPR CVR & FENDER LINER
(USE WITH W&E #3290)
(OUTSIDE DIMENSIONS 33X40 MM)
TOYOTA/LEXUS- AVALON,
CAMRY, GS, ES, & RX 350/HP
2013-UP
UNIT PKG.-5

3361

90467-09212

PLASTIC RETAINER-INTERIOR
QUARTER PANEL & COWL TRIM
TOYOTA-CAMRY, SEQUOIA & TUNDRA
LEXUS-ES-350 & HS HYBRID
UNIT PKG.- 25

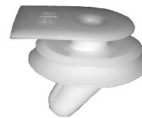

HOLE SIZE-8.5 MM
TOP HD-13X18 MM;BOTTOM HD 18
MM; O/A HEIGHT-16 MM

3330

(11610049)

PLASTIC
BUMPER COVER
TURN & LOCK
RETAINER
(19 MM FLANGE;
24.5 MM O/A
LENGTH)



GM-SUV'S-2007 & UP
UNIT PKG.- 15

WEATHER STRIP CLIPS

2679



(W700548S300)
SCUFF PLATE RETAINER
5 X 24 MM PHILLIPS WASHER
HEAD SCREW- BLACK NYLON
FORD- CONTOUR &
MYSTIQUE

UNIT PKG.-50

1206

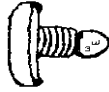

(OE-4876498)
WEATHERSTRIP RETAINER
PLASTIC NAIL FASTENER
GM, FORD & UNIVERSAL

UNIT PKG.-100

HOLE SIZE-3/16"

2207
(1616923)

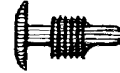

WEATHERSTRIP RETAINER
AND GENERAL USE
GM & UNIVERSAL
UNIT PKG.-50

HOLE SIZE-3/16"
HEAD DIAM.-33/64"
OVERALL HT.-19/32"

2257



WEATHERSTRIP CLIP
HONDA-BLACK NYLON
UNIT PKG.-100

2414



(20413107, 25016383)
(388246A; 6507557AA; 4006516)
WEATHERSTRIP
& PANEL RETAINER
GM/FORD/CHRY/AMC
UNIT PKG.-50

HOLE SIZE-11/64"
HEAD DIAM.-7/16"
OVERALL HT.-23/32"

2618



(HONDA-90664-671-0030)
(REPL.NISSAN-80833-S5000)
WEATHERSTRIP RETAINER
UNIT PKG.-25

HOLE SIZE-4 MM
HEAD SIZE-7 X 16 MM
OVERALL HT.-13 MM

2379



(01553-00172); (90467-07050);
(90687-SA5-0030)
WEATHERSTRIP & TRIM PANEL CLIP
NISSAN, TOYOTA & HONDA
UNIT PKG.-25

HOLE SIZE-5 MM
HEAD DIAM.-13 MM
OVERALL HT.-17 MM

2652



(20699808, 6502328)
WEATHERSTRIP RETAINER
GM & CHRYSLER

UNIT PKG.- 50

HOLE SIZE-5 MM
HEAD DIAM.-10 MM
OVERALL LENGTH-13 MM

2759



(OE-20538173;6104908AA;002-997-33-
86-67)
WEATHERSTRIP RETAINER
(GM-CHEV.,BUICK,PONT.,OLDS);
CHRY;MERC-1989-UP

UNIT PKG.-50

HOLE SIZE-3/16";HEAD DIAM-
7/16";STEM LGTH-1/2"

2628



(21077575), (4696129)
WEATHERSTRIP RETAINER
GM SATURN & CHRYSLER
UNIT PKG.-50

HOLE SIZE-4 MM; HEAD SIZE-7 X 17 MM
OVERALL HT.-14 MM

2766



(73862-672-0030)
WEATHERSTRIP CLIP
HONDA

UNIT PKG.- 25

HOLE SIZE-5 MM
HEAD SIZE-7 X 16 MM

2844

(N807438S, W704643)



(REPLACES-91568-SR2-003, 91530-SP1-03)
WEATHERSTRIP RETAINER
FORD & HONDA
UNIT PKG.-100

HOLE SIZE-5 MM
HEAD SIZE-5 X 15 MM
STEM-10 MM









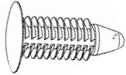

2845

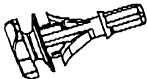

(10405030, 10283414)
WEATHERSTRIP RETAINER-GM
UNIT PKG.-50

HOLE SIZE-5.5 MM
HEAD SIZE-5 X 15 MM; STEM-7 MM

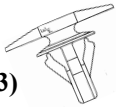
WEATHER STRIP CLIPS

<p>2848</p>  <p>(CHRYSLER-4658673) (GM-10293674) WEATHERSTRIP RETAINER GM & CHRYSLER NEON UNIT PKG.- 50</p> <div style="border: 1px solid black; padding: 2px; margin-top: 10px;"> <p>HOLE SIZE-5 MM HEAD DIAM.-10 MM STEM-16 MM</p> </div>	<p>2923</p>  <p>(OE #-N/A) WEATHERSTRIP RETAINER CHRYSLER- LH, LHS 1997 & UP UNIT PKG.-100</p> <div style="border: 1px solid black; padding: 2px; margin-top: 10px;"> <p>HOLE SIZE-5 MM HEAD SIZE-6.5 X 16.5 MM</p> </div>	<p>2924</p>  <p>(OE #-N/A) WEATHERSTRIP RETAINER CHRYSLER- LH, LHS 1997 & UP UNIT PKG.-100</p> <div style="border: 1px solid black; padding: 2px; margin-top: 10px;"> <p>HOLE SIZE-4.8 MM HEAD SIZE-6.5 X 11 MM</p> </div>
<p>2925</p>  <p>(OE #-N/A) WEATHERSTRIP RETAINER CHRYSLER- LH, LHS 1997 & UP UNIT PKG.-100</p> <div style="border: 1px solid black; padding: 2px; margin-top: 10px;"> <p>HOLE SIZE-5.2 MM HEAD SIZE-6.5 X 16.5 MM</p> </div>	<p>2933</p>  <p>(OE #-N/A) WEATHERSTRIP RETAINER LINCOLN/ FORD 1989 & UP UNIT PKG.-50</p> <div style="border: 1px solid black; padding: 2px; margin-top: 10px;"> <p>HOLE SIZE-5 MM HEAD SIZE-5 X 15 MM</p> </div>	<p>2990 (01553-09311)</p>  <p>WEATHERSTRIP CLIP NISSAN- ALTIMA & SENTRA 1994 & UP UNIT PKG.-25</p> <div style="border: 1px solid black; padding: 2px; margin-top: 10px;"> <p>HOLE SIZE- 6 MM HEAD - 7 X 16 MM OVERALL LENGTH-13.5MM</p> </div>
<p>3011</p>  <p>(10169777) WEATHERSTRIP CLIP GM-"W" BODIES '95 & UP UNIT PKG.-25</p> <div style="border: 1px solid black; padding: 2px; margin-top: 10px;"> <p>HOLE SIZE-5 MM HEAD DIAM.-11 MM OVERALL LENGTH-10 MM</p> </div>	<p>3014</p>  <p>(W708088-S300) WEATHERSTRIP CLIP FORD-'96 & UP UNIT PKG.-50</p> <div style="border: 1px solid black; padding: 2px; margin-top: 10px;"> <p>HOLE SIZE-3/16" HEAD DIAM.-3/8" OVERALL LENGTH-23/32"</p> </div>	<p>3075 (91530-ST5-003) (REPL.-91516-SM4-003)</p>  <p>WEATHERSTRIP RETAINER HONDA- CIVIC DOORS-'95 & UP ODYSSEY HOOD SEAL-'99 & UP ACURA-'96 & UP UNIT PKG.-10</p> <div style="border: 1px solid black; padding: 2px; margin-top: 10px;"> <p>HOLE SIZE- 6 MM; HEAD - 5 X 15 MM OVERALL LENGTH-12 MM</p> </div>
<p>3100 (67867-12150) (REPLACES-67868-02020) WEATHERSTRIP CLIP FRONT AND REAR DOORS TOYOTA-'90 & UP LEXUS-'99 & UP AVALON-'95 & UP UNIT PKG.-25</p>  <div style="border: 1px solid black; padding: 2px; margin-top: 10px;"> <p>HOLE SIZE- 6 MM HEAD - 5 X 15 MM OVERALL LENGTH-16 MM</p> </div>	<p>3103 (OE #-N/A) WEATHERSTRIP RETAINER -VW UNIT PKG.-100</p>  <div style="border: 1px solid black; padding: 2px; margin-top: 10px;"> <p>HOLE SIZE- 4 MM HEAD - 6 X 17 MM OVERALL LENGTH-9 MM</p> </div>	

WEATHER STRIP CLIPS

3104



(OE #-N/A)
WEATHERSTRIP RETAINER-DOOR
CHRYSLER PACIFICA
2003 AND UP
UNIT PKG.-100

HOLE SIZE-3.3 MM
 HEAD DIAM.-6 X 12 MM
 OVERALL LENGTH-11 MM

3105

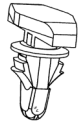

(OE #-N/A)
WEATHERSTRIP
RETAINER- DOOR
CHRYSLER, DODGE DURANGO
2003 AND UP
UNIT PKG.-50

HOLE SIZE-5 MM
 HEAD DIAM.-7 X 14 MM
 OVERALL LENGTH-13 MM

3106

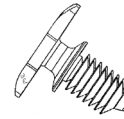

(OE #-N/A)
WEATHERSTRIP
RETAINER- DOOR
CHRYSLER SEBRING
DODGE STRATUS-2003 & UP
UNIT PKG.-50

HOLE SIZE-5 MM
 HEAD-5 X 15 MM
 OVERALL HEIGHT- 15 MM

3107

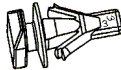

(OE #-N/A)
WEATHERSTRIP RETAINER- DOOR
FORD "S" SERIES TRUCKS,
EXPLORER, & EXPLORER-SPORT
MERCURY MOUNTAINEER
1996 AND UP

UNIT PKG.-100

HOLE SIZE-5 MM
 HEAD-5 X 14 MM
 OVERALL HEIGHT-14 MM

3166

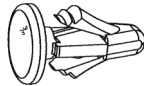

(OE #-N/A)
WEATHERSTRIP CLIP
FORD F SERIES
PICK UP- 2004 & UP

UNIT PKG.-100

HOLE SIZE-7 MM
 HEAD-10 MM
 OVERALL HT- 16 MM

3167



(OE #-N/A)
WEATHERSTRIP CLIP
CHRYSLER 300 &
DODGE MAGNUM-2005 & UP
UNIT PKG.-100

HOLE SIZE-6 MM
 HEAD: 5 X 15 MM
 OVERALL HT- 9 MM

3175

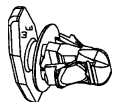

(OE #-N/A)
DOOR WEATHERSTRIP
RETAINER
ACURA, FORD, HONDA,
& MITSUBISHI

UNIT PKG.-100

HOLE SIZE-5 MM
 HEAD- 5 X 15 MM
 OVERALL HT- 11.5 MM

3178

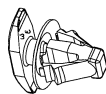

(OE #-N/A)
WEATHERSTRIP
RETAINER
DOOR & HOOD SEALS
FORD/LINCOLN

UNIT PKG.-100

HOLE SIZE-5.3 MM
 HEAD-5 X 15 MM
 OVERALL HT- 12.5 MM

3179



(OE #-N/A)
WEATHERSTRIP
RETAINER
DOOR & HOOD SEALS
JEEP, CHRYSLER NEON,
STRATUS, SEBRING

UNIT PKG.-100

HOLE SIZE-6 MM
 HEAD-5 X 15 MM
 OVERALL HT- 11.6 MM

3303

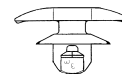





(90467-04034)
DOOR WEATHERSTRIP
RETAINER
TOYOTA/ LEXUS
2008 & UP

UNIT PKG.- 50

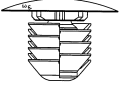
FOR 5 MM HOLE SIZE
 5 X 15 MM TOP HEAD
 9 MM OVERALL HEIGHT

WEATHER STRIP/ HOOD SEAL CLIPS

<p>3239</p>  <p style="text-align: center;">(OE #-N/A) WEATHERSTRIP RETAINER GM TRUCKS/ LIGHT TRUCKS 2007 AND UP UNIT PKG.- 50</p> <div style="border: 1px solid black; padding: 2px; text-align: center; font-size: small;"> HOLE SIZE-8 MM HEAD DIAM.-16 MM OVERALL HEIGHT-11 MM </div>	<p>3240</p>  <p style="text-align: center;">(OE #-N/A) WEATHERSTRIP RETAINER GM TRUCKS/ LIGHT TRUCKS 2000 AND UP UNIT PKG.- 50</p> <div style="border: 1px solid black; padding: 2px; text-align: center; font-size: small;"> HOLE SIZE-5 MM HEAD DIAM.-11 MM OVERALL HEIGHT-13 MM </div>	<p>2971</p>  <p style="text-align: center;">(91502-S84-A11) HOOD SEAL CLIP HONDA- ACCORD & ODYSSEY '98 & UP UNIT PKG.-15</p> <div style="border: 1px solid black; padding: 2px; text-align: center; font-size: small;"> HOLE SIZE-6 MM HEAD DIAM.-6 X 16 MM, OVERALL LENGTH-16 MM </div>
<p>2523</p>  <p style="text-align: center;">(90467-08004; 90467-08011) (90467-A0009; 90080-46010) PANEL /HOOD SEAL CLIP TOYOTA UNIT PKG.-25</p> <div style="border: 1px solid black; padding: 2px; text-align: center; font-size: small;"> HOLE SIZE-5 MM HD. DIAM.-13 MM </div>	<p>2687</p>  <p style="text-align: center;">(91520-SM4-C010) (SUB FOR 91518-S10-003) RETAINER-HOOD & OTHERS ACURA/HONDA-ODYSSEY UNIT PKG.-25</p> <div style="border: 1px solid black; padding: 2px; text-align: center; font-size: small;"> HOLE SIZE-6 MM HEAD DIAM.-10 MM STEM-10 MM </div>	<p>2961</p>  <p style="text-align: center;">(90467-06161-01) RETAINING CLIP TOYOTA UNIT PKG.-25</p> <div style="border: 1px solid black; padding: 2px; text-align: center; font-size: small;"> HOLE SIZE-5 MM; HD. DIAM.-14 MM STEM-10 MM PANEL THICKNESS-3 MM </div>
<p>2964</p>  <p style="text-align: center;">(HONDA-66435-648-000F) (REPLACES- NISSAN-01553-00291) RETAINING CLIP HONDA, NISSAN UNIT PKG.-50</p> <div style="border: 1px solid black; padding: 2px; text-align: center; font-size: small;"> HOLE SIZE-5.5 MM HD. DIAM.-11 MM STEM-15 MM </div>	<p>2966</p>  <p style="text-align: center;">(91518-SM4-003) RETAINER-HOOD & TRUNK MOULDING ACURA/HONDA CIVIC-'94 & UP UNIT PKG.-15</p> <div style="border: 1px solid black; padding: 2px; text-align: center; font-size: small;"> HOLE SIZE-6 MM HEAD DIAM.-12 MM STEM-9 MM </div>	<p>3336</p>  <p style="text-align: center;">(90467-08136) PLASTIC RETAINER FENDER SEAL, RADIATOR SPLASH SHIELD & INT. DOOR TRIM TOYOTA/LEXUS-'07 & UP UNIT PKG.-25</p> <div style="border: 1px solid black; padding: 2px; text-align: center; font-size: small;"> HOLE SIZE-7 MM HEAD DIAM.-20 MM STEM LENGTH-9 MM </div>
<p>3094 (65810-K2000)</p>  <p style="text-align: center;">HOOD SEAL RETAINER NISSAN MAXIMA-2000 & UP INFINITY-QX4; M45- '97&UP UNIT PKG.-25</p> <div style="border: 1px solid black; padding: 2px; text-align: center; font-size: small;"> HOLE SIZE-5 MM HEAD-7 X 16 MM OVERALL HT- 11.5 MM </div>	<p>3205 (GM-10293193), (FORD-N811040-S)</p>  <p style="text-align: center;">PLASTIC RETAINER HOOD SEAL, WEATHERSTRIP, INSTRUMENT PANEL & INSULATION GM-2005 & UP; CHEVY COBALT; PONTIAC; FORD-MUSTANG UNIT PKG.-50</p> <div style="border: 1px solid black; padding: 2px; text-align: center; font-size: small;"> HOLE SIZE-7 MM; HD DIAM. 13 MM OVERALL HT.-18 MM </div>	<p>3341</p>  <p style="text-align: center;">(BP4K-58-762) PLASTIC WEATHERSTRIP RETAINER MAZDA-'04 & UP UNIT PKG.-25</p> <div style="border: 1px solid black; padding: 2px; text-align: center; font-size: small;"> FOR 4 MM HOLE; 9 MM HD DIAM.; 7 MM STEM LENGTH </div>

RETAINERS HOOD INSULATION, COWL

1222

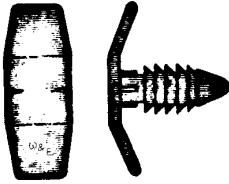

(383927-S, 384051-S), (480534)
**RETAINER CLIP-COWL TO HOOD
 INSULATION & SPLASH SHIELD
 FORD AND GM
 UNIT PKG.-50**

HOLE-1/4"
 HD DIAM.-1" X 0.4"
 OVERALL HT-23/32"

1223



(1609141, 2998430)
**RETAINER-UNIVERSAL TRIM
 & PANEL CLIP, UPPER GRILLE
 CHRYSLER
 UNIT PKG.-25**

HOLE SIZE-1/4"
 HEAD DIAM.-1.25"

1224

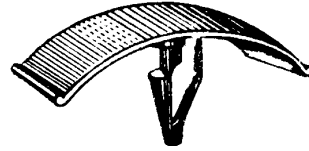

(OE-385330-S), (6003351)
**HOOD INSULATION CLIP
 FORD & CHRYSLER-'73 & UP
 UNIT PKG.-50**

HOLE SIZE-1/4"
 HEAD SIZE-1/2" X 5/8"

2230

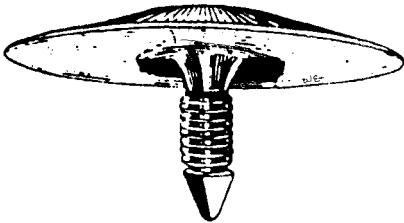

(3078511, REPLACES 3977775)
**HOOD INSULATION CLIP-GM AND UNIVERSAL
 UNIT PKG.-50**

HOLE SIZE-1/4"; HEAD DIAM.-2"; STEM-3/4"

2425

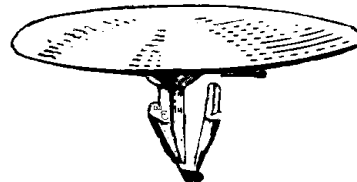

(OE 388908-S)
**HOOD INSULATION CLIP
 FORD- '79 & UP
 UNIT PKG.-50**

HOLE SIZE-6 MM
 HEAD DIAM.-45 MM
 OVERALL HEIGHT-21 MM

2493

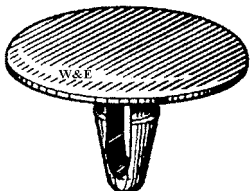

(90467-09008)
**HOOD INSULATION CLIP
 TOYOTA
 UNIT PKG.-20**

HOLE SIZE-7 MM
 HEAD DIAM.-30 MM

2583

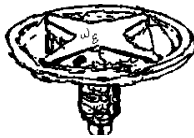

(65846-30FOO)
 (SUB FOR 65832-F5000)
**HOOD INSULATION CLIP
 NISSAN- '81 & UP
 UNIT PKG.-25**

HOLE SIZE- 5 MM
 HEAD DIAM.-30 MM



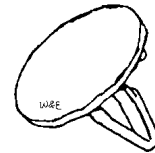



2656

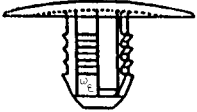

(6502842), (21039129)
**HOOD INSULATION RETAINER
 CHRYSLER- LH & NS MINIVANS
 GM-SATURN
 UNIT PKG.-50**

HOLE SIZE- 1/4"
 HEAD DIAM.-1-3/16"

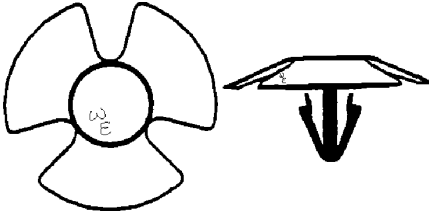
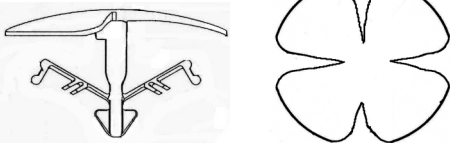
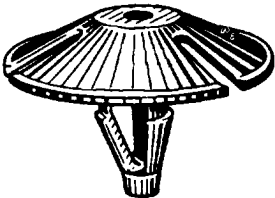
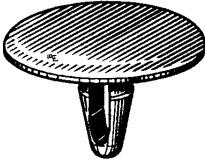
RETAINERS- HOOD INSULATION

<p>2678</p>  <p>(W700671S300) HOOD INSULATION RETAINER FORD CONTOUR, MYSTIQUE & FOCUS UNIT PKG.-25</p> <div style="border: 1px solid black; padding: 2px; width: fit-content; margin: 0 auto;"> <p>HOLE SIZE- 8 MM HEAD DIAM.-25 MM</p> </div>	<p>2752</p>  <p>(6503274); (6503971); (52009077); (J3081054) RETAINER- HOOD INSULATION, CARPET, & WIRE HARNESS- CHRYSLER UNIT PKG.- 25</p>	<p>2801</p>  <p>(11609690;6504098; N808842-S;W705002-S300) HOOD INSULATION CLIP GM, CHRYSLER & FORD '96 & UP UNIT PKG.-50</p> <div style="border: 1px solid black; padding: 2px; width: fit-content; margin: 0 auto;"> <p>HOLE SIZE-1/4" HD. DIAM.-1-1/4" OVERALL HT.-25/32"</p> </div>	<p>2967</p>  <p>(65846-40F00;65846-4Z- 000) HOOD INSULATION RETAINER NISSAN- '89 & UP UNIT PKG.-15</p> <div style="border: 1px solid black; padding: 2px; width: fit-content; margin: 0 auto;"> <p>HOLE SIZE-5 MM HEAD DIAM.-28 MM OVERALL HEIGHT-11MM</p> </div>
<p>2913</p>  <p>(90467-09050, 90467-A0003) PLASTIC HOOD INSULATION RETAINER TOYOTA CAMRY & SOLARA- LEXUS-'98 & UP UNIT PKG.-15</p> <div style="border: 1px solid black; padding: 2px; width: fit-content; margin: 0 auto;"> <p>HOLE SIZE-7 MM HEAD DIAM.-25 MM STEM-10 MM</p> </div>	<p>2927</p>  <p>(4878883AA) HOOD INSULATION RETAINER CHRYSLER- LH, LHS '97 & UP UNIT PKG.-50</p> <div style="border: 1px solid black; padding: 2px; width: fit-content; margin: 0 auto;"> <p>HOLE SIZE-6.35 MM (1/4") HEAD DIAM.-30 MM</p> </div>	<p>3374</p>  <p>(91501-SWA-003) HOOD INSULATION RETAINER HONDA-ACCORD, CR-V, CIVIC & INSIGHT; ACURA-RDX, ILX & TSX- 2012-UP UNIT PKG.-25</p> <div style="border: 1px solid black; padding: 2px; width: fit-content; margin: 0 auto;"> <p>HOLE SIZE-7 MM HEAD DIAM.-30 MM O/A HEIGHT-18 MM</p> </div>	
<p>2957</p>  <p>(4341060) HOOD INSULATION & FENDER SHIELD RETAINER- CHRYSLER '85 & UP UNIT PKG.-25</p>	<p>2972</p>  <p>(90467-09006) HOOD INSULATION CLIP TOYOTA- AVALON, & CAMRY; LEXUS-'88 & UP UNIT PKG.-10</p> <div style="border: 1px solid black; padding: 2px; width: fit-content; margin: 0 auto;"> <p>HOLE SIZE-6 MM HEAD DIAM.-30 MM OVERALL LENGTH-20 MM</p> </div>	<p>2973</p>  <p>(90700-SJ4-000) HOOD INSULATION CLIP; HONDA ACCORD & ACURA LEGEND '91 & UP UNIT PKG.-15</p> <div style="border: 1px solid black; padding: 2px; width: fit-content; margin: 0 auto;"> <p>HEAD DIAM.-30 MM O/A LENGTH-12 MM</p> </div>	<p>2983</p>  <p>(20064875) PLASTIC INSULATION HOOD RETAINER GM-'80 & UP UNIT PKG.-25</p> <div style="border: 1px solid black; padding: 2px; width: fit-content; margin: 0 auto;"> <p>HOLE SIZE-1/4"; HEAD DIAM.-1-5/8"; STEM-3/4"</p> </div>

RETAINERS- HOOD INSULATION, TRIM PANEL

2993

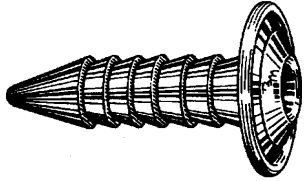

(GM 7642589), (AMC 4001934),
(FORD W709883-S300)
FIREWALL INSULATION
RETAINER-GM, AMC, FORD
UNIT PKG.-25

HOLE SIZE-3/8"
HEAD DIAM.-1"; STEM-1.3"

3083

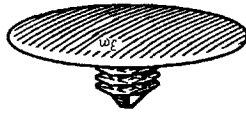

(90700-SB2-003)
PLASTIC RETAINER
HOOD INSULATION
HONDA-PRELUDE-'85 & UP
INSIGHT-'00 & UP
ACURA-'96 & UP
UNIT PKG.-15

HOLE SIZE-6 MM
HEAD DIAM.-30 MM
OVERALL HEIGHT-11 MM

3058

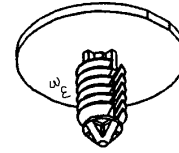

(6504135)
HOOD INSULATION CLIP
CHRYSLER MINIVANS &
DODGE DURANGO
'97 & UP
UNIT PKG.-50

HOLE SIZE-1/4"
HEAD DIAM.-1"

3119

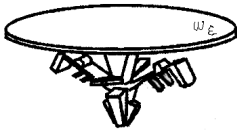

(91501-S1K-0030; 91501-STK-0030)
HOOD INSULATION CLIP
HONDA-ACCORD, CIVIC
CRV, ACURA-2000 & UP

UNIT PKG.-25

HOLE SIZE- 7 MM
HEAD DIAM.-30 MM
OVERALL HT.- 16 MM

3231



(81126-37010)
HOOD INSULATION
RETAINER
KIA & HYUNDAI
1996 & UP
UNIT PKG.-25

HOLE SIZE-8 MM
HEAD DIAM.-26 MM
OVERALL HEIGHT- 16 MM

3208

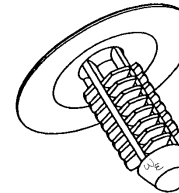

(22718305, N-802734S, 6506788)
BLACK PLASTIC RETAINER
HOOD INSULATION, FENDER APRON,
FRONT BUMPER COVER &
INTERIOR TRIM PANEL
GM, FORD, CHRYSLER '83 & UP
UNIT PKG.-50

HOLE SIZE-7 MM
HEAD DIAM.-25 MM
OVERALL HT.-26 MM

3305

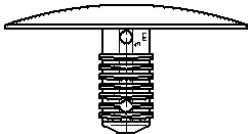

(90913-0074, 91501-TA0-0000)
PLASTIC RETAINER
HOOD INSULATION
HONDA, SUBARU
2008 & UP
UNIT PKG.-15

HOLE SIZE-7 MM
HEAD DIAM- 30 MM
OVERALL HEIGHT-16 MM

3342

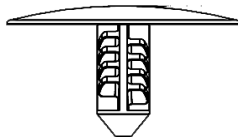

(11571159)
PLASTIC HOOD
INSULATION RETAINER
GM-CHEVY CRUZE, EQUINOX,
& VOLT-GMC-TERRAIN
2010-UP

UNIT PKG.-25

HOLE SIZE-7 MM
HEAD DIAM- 30 MM
STEM LENGTH-15 MM

3363



(90814-FC001)
PLASTIC HOOD
INSULATION RETAINER
SUBARU-B9 TRIBECA, IMPREZA,
FORESTER & LEGACY OUTBACK
2009-UP

UNIT PKG.-10

HOLE SIZE-9 MM
HEAD DIAM- 30 MM
STEM LENGTH-13 MM

PLASTIC RETAINERS-INTERIOR TRIM PANEL

2278

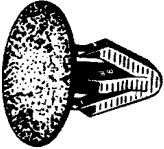

(REPLACES 01553-00051)
TRIM PANEL RETAINER
 BLACK PLASTIC
 TOYOTA & DATSUN
 UNIT PKG.-25

2363

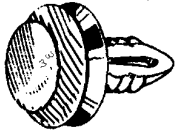

(387477-S)
INTERIOR TRIM PANEL CLIP
 FORD-ALL MODELS-'77 & UP
 UNIT PKG.-50

2364



(N802900, N801925-S)
TRIM PANEL CLIP
 FORD-ALL MODELS-'80 & UP
 UNIT PKG.-25

FOR 1/4" HOLE; 1/2" TOP HD DIAM.

2373



(90687-671-0030)
INTERIOR PANEL FASTENER
 HONDA
 UNIT PKG.- 10

10 MM HOLE; 20 MM HD DIAM.
 OVERALL LENGTH-23 MM

2455

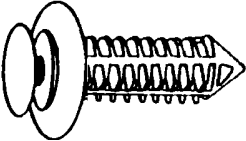

(FORD-N805612-S)
 (GM-10143422)
 (CHRYSLER- 34202599)
 (AMC- 893202-599)
DOOR PANEL FASTENER
 FORD, GM, CHRYSLER
 JEEP EAGLE, PREMIER -'88 & UP
 UNIT PKG.-25

2492



(89421-76980), (76906-T3000)
 (90467-09069-06:-20,-21), (9926-40-658)
INTERIOR PANEL FASTENER
 ISUZU, NISSAN, TOYOTA, MAZDA
 UNIT PKG.-20

HOLE SIZE-7 MM
 HEAD DIAM.-14 MM
 OVERALL LENGTH-19 MM

2504

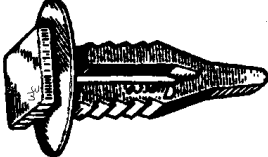

(10093200,20036949)
TRIM PANEL RETAINER
 GM-"A" BODY- '76 & UP
 UNIT PKG.-25

2561

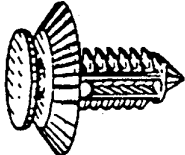

(21042058, 21042045)
 (21042104, 21042053)
DOOR TRIM PANEL RETAINER
 GM SATURN-'91 & UP
 UNIT PKG.-50

HOLE SIZE-8 MM
 OVERALL LENGTH-24 MM

2677

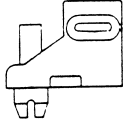

(W701430S300)
DOOR TRIM RETAINER
 FORD- CONTOUR & MYSTIQUE
 UNIT PKG.-25

HOLE SIZE-7 MM

2706



(01553-S3500)
DOOR TRIM PANEL RETAINER
 NISSAN TRUCKS
 UNIT PKG.-50

HOLE SIZE-8 MM
 OVERALL LENGTH-21 MM

2760

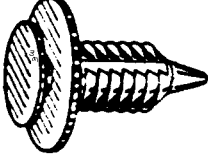

(6503709); (REPLACES FORD-N805155S)
TRIM PANEL CLIP
 FORD, DODGE
 '94 & UP
 UNIT PKG.-50

HOLE SIZE-9/32", STEM-3/4"

2785



(F58B16237A02AB)
DOOR TRIM PANEL CLIP
 FORD WINDSTAR-95 & UP
 UNIT PKG.-25

HOLE SIZE-8 MM
 OVERALL LENGTH-24 MM

PLASTIC RETAINERS—INTERIOR / EXTERIOR

3203

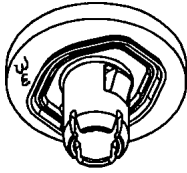

(22722860)
DOOR TRIM PANEL GROMMET
 GM-VARIOUS MODELS 2002 & UP
 (USE WITH W&E #3218)

UNIT PKG.-25

HOLE SIZE- 9 MM
 FLANGE- 24 MM

3218

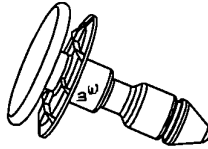

(11561499; REPL. 22722859 & 10363811)
DOOR PANEL RETAINER PIN
 (USE WITH W&E #3203)
 OLDS, CADILLAC, CHEVY, PONTIAC
 GM- 2002 & UP

UNIT PKG.-25

HEAD DIAM.-20 MM
 OVERALL LENGTH— 28 MM

3010

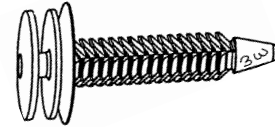

(10421018)
DOOR TRIM PANEL CLIP
 GM-'97 & UP

UNIT PKG.-25

HOLE SIZE-7 MM
 TOP HEAD DIAM.18 MM
 OVERALL LENGTH- 41 MM

1225



(14093311), (332364), (20732399)
 (389358S), (6031321), (3691590)
SCREW NAIL RETAINER
BLACK
 GM, AMC & UNIVERSAL

UNIT PKG.-50

HOLE SIZE-1/4"
 HEAD DIAM.-45/64"
 STEM LENGTH-5/8"

2107

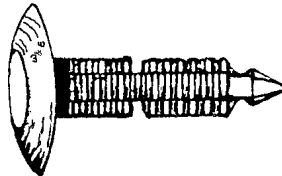

(15552345, 1699250)
 (REPLACES:GM-14074081)
INTERIOR TRIM RETAINER
 GM & UNIVERSAL

UNIT PKG.-25

FOR 7 MM HOLE
 HEAD DIAM.-19 MM
 OVERALL LENGTH— 34.5 MM

2108

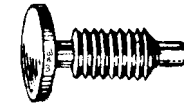

(411700)
RETAINER- FLEXIBLE
FILLER BETWEEN
IMPACT BUMPER
& FENDER- BLACK
 GM & UNIVERSAL
UNIT PKG.-100

HOLE SIZE-1/4"
 HEAD DIAM.-1/2"
 OVERALL HEIGHT-13/16"

2140

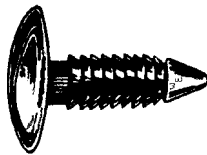

(GM-1605396), (FORD-388577S, W705589S)
 (CHRYSLER-6030441, 3691590), (AMC-4004919, 4004569)
SCREW NAIL RETAINER-YOKE SHIELD TO SUPPORT
MOULDING, FENDERS, ETC.
 (1/4" LONGER THAN W&E #1225)
 GM, CHRYSLER, FORD & AMC

UNIT PKG.-50

HOLE SIZE-1/4"
 HEAD DIAM.-45/64"
 STEM-13/16"

2204

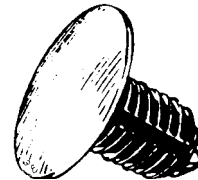





(1619321)
PANEL FASTENER-
RADIATOR SKIRT ATTACHING
CADILLAC & GM

UNIT PKG.-25

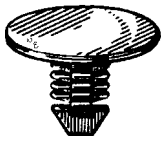
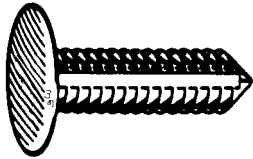
HOLE SIZE-13/32"; HD DIAM.-1"
 STEM LENGTH -13/16"

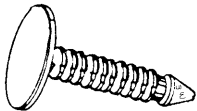
PLASTIC RETAINERS-INTERIOR / EXTERIOR

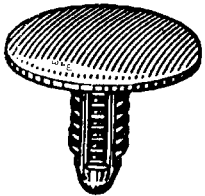
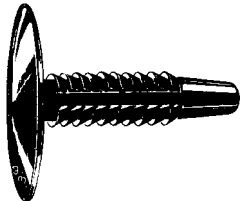
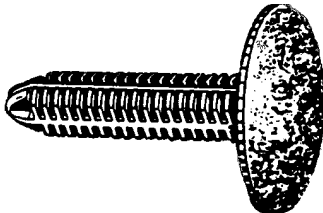
<p>2279</p>  <p style="text-align: center;">(OE-6270163) SCREW NAIL RETAINER GREY GM, AMC & UNIVERSAL UNIT PKG.-50</p> <div style="border: 1px solid black; padding: 2px; text-align: center; margin-top: 10px;"> HOLE SIZE-1/4" HD DIAM.-45/64" STEM LENGTH-5/8" </div>	<p>2299</p>  <p style="text-align: center;">(FORD-387258-S) (GM-20032850, 15676621) (CHRYSLER-3861577) RETAINER- MUD SHIELD, DOOR SOUND ABSORBER, DUSTSHIELD UNIT PKG.- 50</p> <div style="border: 1px solid black; padding: 2px; text-align: center; margin-top: 10px;"> HOLE SIZE-1/4" HEAD DIAM.-3/4" STEM LENGTH-1/2" </div>	<p>2347</p>  <p style="text-align: center;">(10185925) INTERIOR TRIM CLIP- BLACK GM, FORD & UNIVERSAL</p> <p style="text-align: center;">UNIT PKG.-25</p> <div style="border: 1px solid black; padding: 2px; text-align: center; margin-top: 10px;"> HOLE SIZE-7 MM HD. DIAM.-20 MM GRIP RANGE-30 MM </div>
<p>2356</p>  <p style="text-align: center;">(34202787,11561732;1631564;N804379S) BUMPER FASCIA RETAINER GM, FORD, AMC, CHRYSLER '85 & UP UNIT PKG.-25</p> <div style="border: 1px solid black; padding: 2px; text-align: center; margin-top: 10px;"> HOLE SIZE-10 MM HEAD DIAM.-21 MM STEM LENGTH-28MM </div>	<p>2365</p>  <p style="text-align: center;">(20514862) GRILLE RETAINER GM- "N" BODY- '85 & UP</p> <p style="text-align: center;">UNIT PKG.-100</p> <div style="border: 1px solid black; padding: 2px; text-align: center; margin-top: 10px;"> HOLE SIZE-1/8" HEAD DIAM.-15/64" OVERALL HEIGHT-51/64" </div>	<p>2367</p>  <p style="text-align: center;">CHRYSLER- (6003349, 6003423) GM- (2088248, 15599064) FORD- (385661S) VW-(N989022) INTERIOR TRIM PANEL CLIP CHRYSLER, GM, FORD, VW UNIT PKG.-50</p> <div style="border: 1px solid black; padding: 2px; text-align: center; margin-top: 10px;"> FOR 7 MM HOLE 24 MM HEAD DIAMETER OVERALL LENGTH 21 MM </div>
<p>2407</p>  <p style="text-align: center;">(6501067) PANEL FASTENER FASCIA & GENERAL USE CHRYSLER-'84 & UP</p> <p style="text-align: center;">UNIT PKG.-50</p> <div style="border: 1px solid black; padding: 2px; text-align: center; margin-top: 10px;"> FOR 1/4" HOLE; 1" HD DIAM. STEM LENGTH-49/64" </div>	<p>2418</p>  <p style="text-align: center;">(0E-388930-S) (SUB FOR 391039-S) TRIM PANEL RETAINER FORD- 1980 & UP</p> <p style="text-align: center;">UNIT PKG.-50</p> <div style="border: 1px solid black; padding: 2px; text-align: center; margin-top: 10px;"> FOR 1/4" HOLE; HD DIAM.-1" STEM LENGTH-13/16" </div>	<p>2459</p>  <p style="text-align: center;">(FORD-N804349S) (GM-22575287) (CHRYSLER-6502586) INTERIOR TRIM RETAINER FORD, GM & CHRYSLER UNIT PKG.-25</p> <div style="border: 1px solid black; padding: 2px; text-align: center; margin-top: 10px;"> HOLE SIZE-7 MM GRIP RANGE-30 MM </div>

PLASTIC RETAINERS-INTERIOR / EXTERIOR

2461
(389443-S)

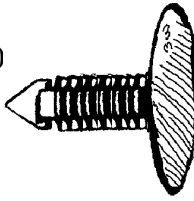

BUMPER FASCIA CLIP
FORD- '81 & UP
UNIT PKG.-25

1/4" HOLE; 1" HD. DIAM.
1-1/16" STEM LENGTH

2512
(22512276)



DOOR PANEL/BUMPER STRIP CLIP
GM-'80 & UP
UNIT PKG.-50

HOLE SIZE-10 MM; HEAD SIZE-.22 MM
OVERALL HEIGHT-24 MM

2629

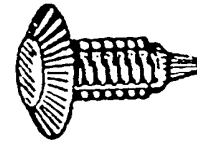

(21094146, 21110201), (6501301)
**TRIM PANEL & WHEEL
WELL RETAINER**
GM SATURN- '91 & UP
CHRYSLER VANS-'87 & UP
UNIT PKG.-25

5/16" HOLE; 3/4" HEAD DIAM. ; 7/8" STEM L.

2643

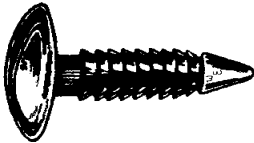

(10077401, 10121502; W709346-S300)
PLASTIC SHIELD CLIP
(LONGER THAN W & E #2140)
GM, FORD & UNIVERSAL

UNIT PKG.-50

HOLE SIZE-1/4"; HD. DIAM.-11/16"
STEM-1-1/16"

2644

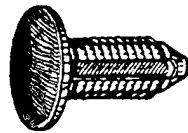

(CHRY.-650403)
(FORD-N807721-S)
TRIM PANEL CLIP
FORD-'93 & UP
CHRYSLER-'95 & UP

UNIT PKG.-50

HOLE SIZE-5/16"
HD. DIAM.-5/8"
STEM-3/4"

2680

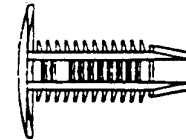

(W7013805SW)
PLASTIC RETAINER
TRUNK LINER, RADIATOR
SHIELD, & CARPET
FORD- CONTOUR & MYSTIQUE

UNIT PKG.-25

HOLE SIZE-7 MM
HEAD DIAM.-18 MM
STEM-22 MM

2861



(10063599)
PLASTIC RETAINER
REMOTE CONTROL
DOOR LOCK
RECEIVER AND UNIVERSAL
UNIT PKG.-100

HOLE SIZE-4 MM;
HEAD DIAM.-9MM
PANEL RANGE-0.8-6 MM

2863

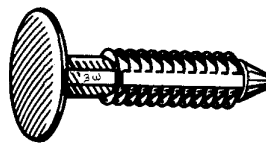

(10146315)
BUMPER FASCIA RETAINER
GM "U" VAN (APV) -'94 & UP

UNIT PKG.-50

HOLE SIZE-1/4"
HEAD DIAM.-11/16"
OVERALL STEM-1-1/4"

2900

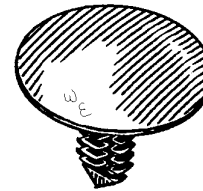

(FORD-388904S)
(CHRYSLER-4381385, 6501086)
BUMPER COVER RETAINER
DOOR FRAME SPACER; BLACK

UNIT PKG.-50

HOLE SIZE-1/4"
HD. DIAM.-1"; STEM-13/16"

2952
(10185866)

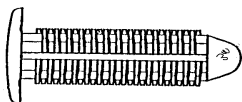

PLASTIC CLIP-HEADLAMP TRIM
GM C, K TRUCKS-'99 & UP

UNIT PKG.-25

HOLE SIZE-7 MM
HD. DIAM.-14 MM; STEM-30 MM

PLASTIC RETAINERS—INTERIOR / EXTERIOR

2976

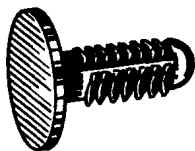

(25601491)
BUMPER COVER RETAINER
DOOR TRIM, RADIATOR BAFFLE
GM- "H" BODY-'92 & UP

UNIT PKG.-50

HOLE SIZE-7 MM
HEAD DIAM.-19 MM

2992



(W707889-S300)
MUD FLAP RETAINER
FORD EXPEDITION & F-150 SERIES
- 1997 & UP
UNIT PKG.-25

HOLE SIZE-1/4"; HD DIAM.-
11/16";STEM LENGTH-1-3/4"

3005

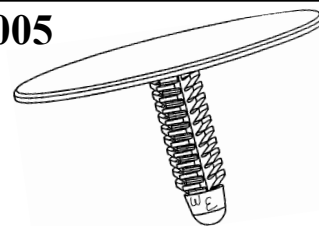

(FORD-N803387-S300;DODGE-
6505302AA)
TRIM PANEL CLIP
UNIT PKG.-25

HOLE SIZE-1/4";HD. DIAM.-1-3/4"
STEM LENGTH-1"

3006

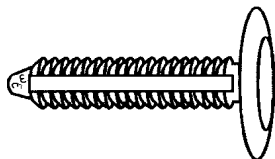

(W701855-S300)
RETAINER-MUD FLAP
AND FENDER LINER
FORD EXPLORER &
MOUNTAINEER-2002
UNIT PKG.-25

HOLE SIZE-6MM
HD. DIAM.-22 MM
STEM LENGTH-35 MM

3007

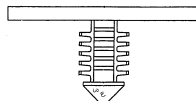

(4696963)
HEADLINER CLIP
CHRYSLER CIRRUS, STRATUS
AND VANS-'95 & UP
UNIT PKG.-25

HOLE SIZE-6 MM
HD. DIAM.-27 MM
OVERALL LENGTH-13 MM

3008

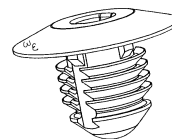

(GM-15056810)
(CHRY.-6505686AA)
RETAINER-BUMPER FASCIA
GM-S/T TRUCKS-2002
CHRYSLER-2000 & UP
UNIT PKG.-25

HOLE SIZE-12.5 MM
HD. DIAM.-25 MM
OVERALL LENGTH-19 MM

3009

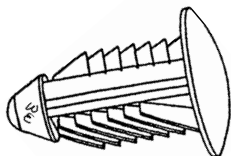

(11518201), (25665391)
RETAINER-BUMPER FASCIA
GM-"N" BODIES-'99 & UP

UNIT PKG.-25

HOLE SIZE-10.5 MM
HD. DIAM.-21.5 MM
OVERALL LENGTH-32 MM

3056

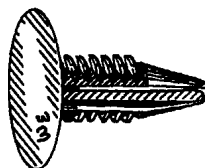

(20319841)
RETAINER-SEAT BACK
BLACK
GM-CAMARO, FIREBIRD
CHEVY S&T TRUCKS
1982 & UP
UNIT PKG.-25

HOLE SIZE-1/4"
HD. DIAM.-13/16"
STEM LENGTH-1"

3064

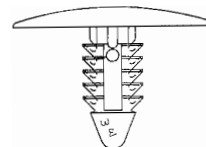

(16674629), (6503943),
(N806113-S)
INTERIOR TRIM PANEL
RETAINER

GM, CHRYSLER & FORD
UNIT PKG.-50

HOLE SIZE-1/4"
HEAD O.D.-1"
STEM LENGTH-5/8"

PLASTIC RETAINERS/COWL TRIM-INTERIOR / EXTERIOR

3097
(GM 10182300)
(CHRY 6033018)
(FORD N803678-S)

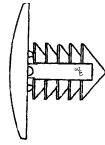

PLASTIC RETAINER
FRONT BUMPER, FENDER,
TRIM PANELS, SEAT, & CARPET
BLACK
GM, CHRYSLER, FORD
UNIT PKG.-50

HOLE SIZE-6.3 MM
HEAD DIAM.-18.5 MM; STEM-11 MM

3098

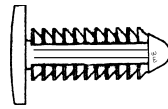

(CHRY 6505417AA)
(FORD W709154S300)
PLASTIC TRIM PANEL
RETAINER-BLACK
CHRYSLER, FORD
UNIT PKG.-50

HOLE SIZE-3/16"
HD. DIAM.-7/16"; STEM-3/4"

3099
(GM 22189414)

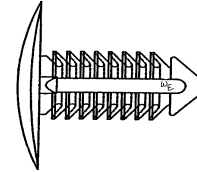

PLASTIC RETAINER-FRONT END
& ENGINE COMPARTMENT
GM-BUICK, CADILLAC & CHEVY
CHRYSLER-JEEP 1999 & UP
UNIT PKG.-25

HOLE SIZE-9 MM
HEAD DIAM.-24 MM
OVERALL LENGTH-23 MM

3170

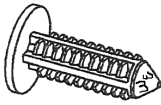

(NISSAN-01553-0075U), (GM-1644290)
BUMPER COVER RETAINER
NISSAN-ALTIMA AND
MAXIMA- 2002 & UP
GM-VARIOUS MODELS-1986 & UP
UNIT PKG.-25

HOLE SIZE-5 MM
HD. DIAM.-11 MM,
OVERALL HEIGHT-19 MM

3261



(90467-A0008)
PLASTIC RETAINER
GRILLE & BUMPER COVER
TOYOTA/ LEXUS 1995 & UP
UNIT PKG.- 50

HOLE SIZE-6.35 MM
HD. DIAM.-19 MM
OVERALL HT.-17 MM

3284

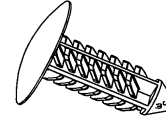

(W711687-S300, 11589181)
BLACK PLASTIC RETAINER
BUMPER SUPPORT, HOOD SEAL,
& FENDER LINER
FORD FOCUS, CHEVY &
GMC PICK-UP-2007 & UP
UNIT PKG.- 25

HOLE SIZE-6.3 MM
HEAD DIAM.-18 MM
OVERALL LENGTH-23 MM

3293



(90467-05125)
PLASTIC FRONT BUMPER
COVER RETAINER
TOYOTA-LEXUS GS SERIES
2006 & UP
UNIT PKG.- 25

HOLE SIZE-5 MM
HEAD DIAM.-16 MM
OVERALL LENGTH-16 MM

3297



(90467-A0002, 90467-08186CO)
PLASTIC INTERIOR
TRIM PANEL RETAINER
TOYOTA - LEXUS-2006 & UP
UNIT PKG.- 25

HOLE SIZE-7 MM
HEAD DIAM.-16 MM
OVERALL LENGTH-20 MM

3311

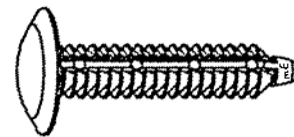

(11562024)
PLASTIC FENDER LINER
BUMPER COVER RETAINER
GM-CADILLAC ESCALADE,
CHEVY/ GMC TRUCKS 2007 & UP
UNIT PKG.-15

FOR 8 MM HOLE
18 MM HEAD DIAMETER
39 MM OVERALL LENGTH

3364
(91566-SP0-003)

PLASTIC RETAINER
TRIM PANELS & SEAT COVERS
HONDA/ACURA- ACCORD,
PILOT, RIDGELINE,
MDX & RDX -1990 & UP
UNIT PKG.- 15



HOLE SIZE-9 MM
TOP HD DIAM. -13 MM
OVERALL LENGTH-22 MM







3365

(G032-68-865A-00;
REPL. 5R3Z-54310D12-BAA)
PLASTIC RETAINER-COWL, TRIM
PANEL, FNDR INSUL. & TRUNK CARPET
MAZDA-5, 6, MIATA, & PROTÉGÉ- 2009 & UP
FORD MUSTANG- 2010 & UP
UNIT PKG.- 25

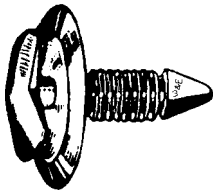
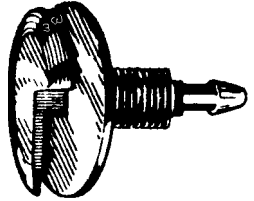

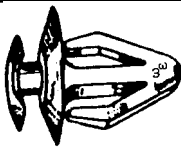
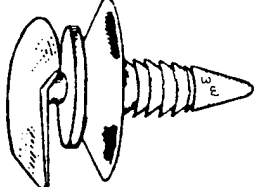
HOLE SIZE-6 MM
HEAD DIAM. -20 MM
O/A LENGTH-17 MM

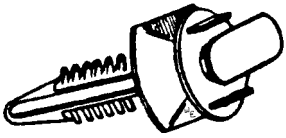
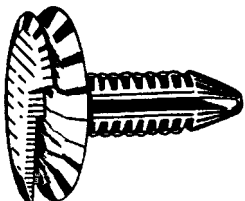
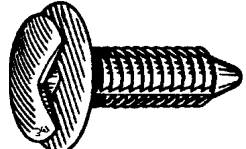
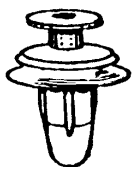
PLASTIC RETAINERS-DOOR TRIM PANEL CLIPS

<p>1205</p>  <p>(2064891), (9883583), (332364) (REPLACES 9818648) DOOR TRIM PANEL FASTENER NYLON; GM PRODUCTS-'71 & UP UNIT PKG.-50</p>	<p>2105</p>  <p>(4005470), (N98905101) (9685057), (6003349), (385661-S) RETAINER- INTERIOR DOOR TRIM PANEL- NYLON AMC, GM, FORD, CHRYS., VW UNIT PKG.-50</p>	<p>2117 (12084605) (387496-S)</p>  <p>TRIM PANEL FASTENER GM & FORD- '76-'78 & UP UNIT PKG.-25</p>
<p>2190</p>  <p>(OE-6003654) PLASTIC RETAINER FENDER SKIRT TO FRONT & REAR BUMPER, DOOR TRIM CHRYSLER-OMNI & HORIZON '78 & UP UNIT PKG.-50</p>	<p>2199</p>  <p>(171-867-299B) (REPLACES: 823-867-299) PLASTIC DOOR CLIP VOLKSWAGON & AUDI UNIT PKG.-25</p>	<p>2224 (3065575) (16656935)</p>  <p>DOOR TRIM TO INNER PANEL FASTENER GM - '77 TO '82 UNIT PKG.-50</p>
<p>2246 (8934-201-681) (34201681) (175-867-299) (REPL.-9818648)</p>  <p>DOOR TRIM PANEL FASTENER- NYLON AMC, CHRYSLER, VW UNIT PKG.-50</p>	<p>2274</p>  <p>(15600382), (20421800) DOOR PANEL FASTENER PLASTIC, GM- '83 & UP UNIT PKG.-25</p>	<p>2286 (20451401)</p>  <p>RETAINER- CONDUIT TO SHEET METAL IN DOORS NYLON- GM "C" BODY UNIT PKG.-25</p>
<p>2291 (363137)</p>  <p>TRIM PANEL RETAINER CHEVY & GMC TRUCK-'76 & UP UNIT PKG.-50</p> <div style="border: 1px solid black; padding: 2px; width: fit-content; margin: 5px auto;"> <p>HOLE SIZE-1/4"; STEM-1"</p> </div>	<p>2375 (67771-12010) (67771-22010) (992740825) (8942264920) (95005064)</p>  <p>DOOR PANEL FASTENER TOYOTA, MAZDA, ISUZU GM-NOVA-'85 UNIT PKG.-25</p>	<p>3353 (91560-SLJ-J01)</p>  <p>PLASTIC RETAINER DOOR TRIM PANEL & HEADLINER HONDA-ACCORD, FIT, & MINIVANS- ACURA-MDX, RDX, TL & TSX- '07-UP UNIT PKG.-15</p> <div style="border: 1px solid black; padding: 2px; width: fit-content; margin: 5px auto;"> <p>HOLE SIZE-8.5 MM; TOP HEAD 13 MM; BOTTOM HEAD 18 MM; O/A LENGTH 17 MM</p> </div>
<p>3378 (67771-32120)</p> <p>DOOR TRIM PANEL RETAINER WITH SEALER TOYOTA/LEXUS -SCION XA, PRIUS, ES 300, GS 300, GS 450H, IS F, IS 250, LS 460, LS 600HL & RX 350 '01-UP UNIT PKG.-15</p> <div style="text-align: center; margin: 10px 0;">  </div> <div style="border: 1px solid black; padding: 5px; width: fit-content; margin: 0 auto;"> <p>FOR 9 MM HOLE; TOP HD 13 X 19 MM; BOTTOM HD 13 MM; O/A HEIGHT- 15 MM</p> </div>		

PLASTIC RETAINERS-INTERIOR / EXTERIOR

2416
(67771-03020)

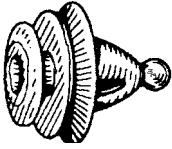

**INTERIOR DOOR TRIM
RETAINER
TOYOTA-CAMRY '88-UP
UNIT PKG.-25**

HOLE SIZE-8.5 MM
OVERALL LENGTH- 19 MM

2417

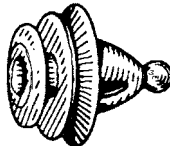

(67771-03030)
**INT. DOOR TRIM RETAINER-
TOYOTA-CAMRY '88-UP**

UNIT PKG.-25

HOLE SIZE-8.5 MM
OVERALL LENGTH- 21 MM

2462

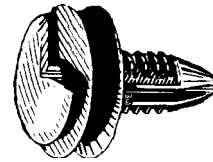

(20374473)
**DOOR PANEL FASTENER
CHEVY-"F" BODY, PONTIAC
& GM- '82 & UP
UNIT PKG.-50**

2490

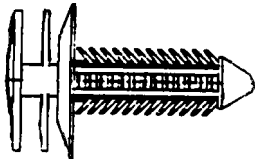

(10153057)
(SUB FOR 15986673)
**DOOR TRIM PANEL CLIP
GM- "W" BODY '88 & UP
UNIT PKG.-25**

HOLE SIZE-7 MM

2511

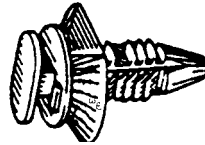

(15612948), (15607165)
**TRIM PANEL RETAINER
GM TRUCKS- '88 & UP
(SMALLER THAN W&E #2274)**

UNIT PKG.-25

2552

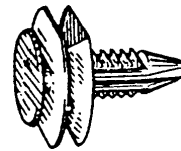

(20734005)
**DOOR PANEL FASTENER
YELLOW COLOR
GM- '88 & UP**

UNIT PKG.-50

HOLE SIZE-1/4"

2621

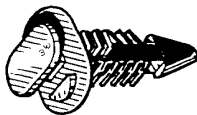

(15953247)
**DOOR PANEL FASTENER
GM TRUCKS- '92 & UP
UNIT PKG.-25**

2705
(10126901)

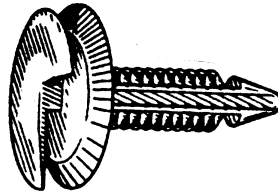

**DOOR PANEL FASTENER
GM- '87 & UP
UNIT PKG.-50**

HOLE SIZE-7 MM
OVERALL LENGTH-38 MM

2707

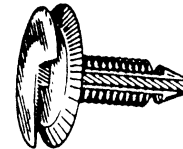

(AMC-4005099), (GM-796255)
(JEEP-6033862),
(NAVISTAR -0501094C1)
**DOOR PANEL FASTENER
AMC- '76 & UP; GM- '81 & UP
JEEP- '91 & UP
UNIT PKG.-25**

2721

(OE-15963179)
(15638413)

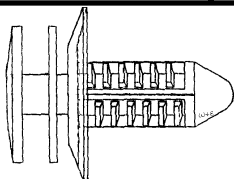

**DOOR PANEL FASTENER
GM TRUCKS- '91 & UP
UNIT PKG.-50**

HOLE SIZE-7 MM

2726

(6502991)

**TRIM PANEL RETAINER
INTERIOR TRIM
& TAIL GATE
JEEP-'93 & UP**

UNIT PKG.-25

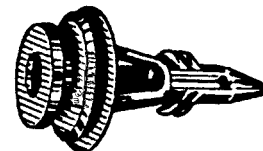

HOLE SIZE-7 MM
STEM LENGTH-25 MM

PLASTIC RETAINERS-INTERIOR / EXTERIOR

2727

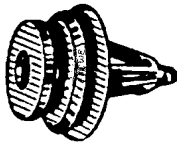

(6502907)
(SUB FOR 6504014)
(SUB FOR 6504452-MINIVANS)
TRIM PANEL RETAINER
JEEP & DODGE TRUCKS
'93 & UP
UNIT PKG.-50

HOLE SIZE-7 MM
STEM LENGTH-15 MM

2794

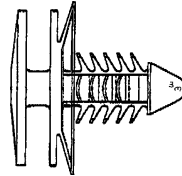

(10287971), (10408480)
TRIM PANEL RETAINER
GM-'97 & UP
UNIT PKG.-50

HOLE SIZE-7 MM; HD. DIAM.-18 MM
STEM-14 MM

2795

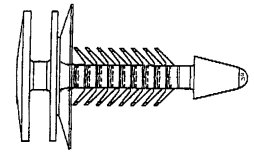

(10285935)
TRIM PANEL RETAINER
GM-'97 & UP
UNIT PKG.-50

HOLE SIZE-7 MM; HD. DIAM.-18 MM
STEM-24 MM

2849

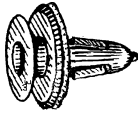

(6503204)
DOOR TRIM PANEL
RETAINER
CHRYSLER- MINIVAN,
CIRRUS & STRATUS, '95 & UP
UNIT PKG.-50

HOLE SIZE-7 MM
STEM-15 MM

2851

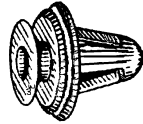

(GM-95008221, 30006620)
(TOYOTA-67771-12050)
(REPLACES-TOYOTA-90467-10161A,
90467-10161, 67771-12040)
DOOR PANEL RETAINER-FRONT&REAR
GEO PRISM, TOYOTA-CELICA,
COROLLA, PREVIA & LEXUS
UNIT PKG.-25

HOLE SIZE-9 MM

2864

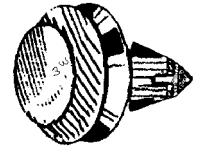

(6505918AA, 6505292AA)
DOOR TRIM PANEL
RETAINER
CHRYSLER VANS- '98 & UP
UNIT PKG.-25

HOLE SIZE-9 MM
OVERALL LENGTH-21 MM

2893

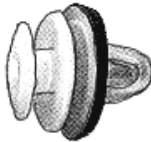

(67771-06070)
DOOR TRIM PANEL RETAINER
TOYOTA- AVALON & CAMRY
'93 & UP
UNIT PKG.-15

2899

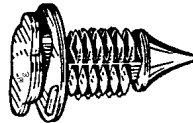

(GM-20298365)
(CHRYSLER-6013122)
TRIM PANEL RETAINER
UNIT PKG.-50

HOLE SIZE-5/16"

2939

(6505539-AA)

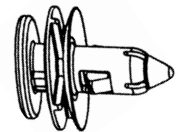

RETAINER-DOOR TRIM PANEL
JEEP GRAND CHEROKEE-'99 & UP
UNIT PKG.-25

HOLE SIZE-7 MM;OVERALL LENGTH-22MM

2948

(91560-SPO-003)

DOOR PANEL CLIP-FRONT & REAR
HONDA-ACCORD, CIVIC,
PRELUDE, ODYSSEY & DEL SOL
ACURA-INTEGRA & LEGEND- 1991 & UP
UNIT PKG.-25

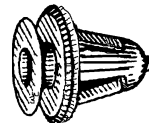

HOLE SIZE-9 MM;TOP HD. DIAM.-13 MM; STEM-12 MM

2962

(TOYOTA-62581-14020)
(MAZDA-9927-40-822)

TRIM PANEL RETAINER
TOYOTA, MAZDA
UNIT PKG.-25



HOLE SIZE-8 MM; SM HD.-14 MM
LG HD. DIAM.-18 MM ; STEM-14 MM

PLASTIC RETAINERS-INTERIOR / EXTERIOR

2978

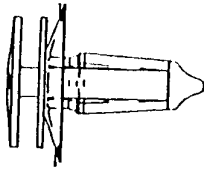

(10257286)
**DOOR TRIM PANEL
 RETAINER**
 GM- MINIVANS-'97 & UP
 UNIT PKG.-25

HOLE SIZE-7 MM
 TOP HD.DIAM.-18 MM
 OVERALL LENGTH-28 MM

3004

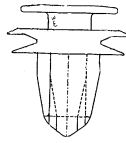

(91560-S84A-A01)
**INTERIOR TRIM
 PANEL RETAINER**
 HONDA ACCORD
 '98 & UP
 UNIT PKG.-25

HOLE SIZE-8 MM
 TOP HEAD DIAM.13 MM
 OVERALL LENGTH- 15 MM

3270



(82315-38000), (94530585)
**PLASTIC DOOR & TRIM PANEL
 RETAINER**
 GM- 2004 & UP
 HYUNDAI- 1999 & UP
 KIA- 2001 & UP
 UNIT PKG.- 25

TOP HEAD DIAM.-13 MM
 OVERALL HEIGHT-17 MM

3017



(75867AA010)
 (REPLACES 75868AA020)
**PLASTIC ROCKER PANEL
 MOULDING CLIP**
 TOYOTA CAMRY-2002
 UNIT PKG.-15

HOLE SIZE-8.5 MM
 TOP HEAD DIAM.13 MM
 OVERALL LENGTH- 19 MM

3037

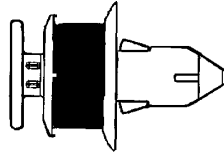

**PLASTIC PUSH RIVET
 DOOR TRIM PANEL CLIP
 WITH SEALER**
 DODGE NEON 2000 & UP
 UNIT PKG.-15

HOLE SIZE-9 MM
 TOP HEAD DIAM.- 16 MM
 FLANGE O.D.-22 MM
 OVERALL LENGTH-30 MM

3041

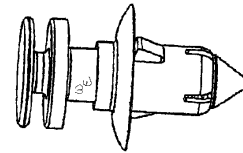

DOOR TRIM PANEL CLIP
 FORD 2001 & UP
 UNIT PKG.-25

HOLE SIZE-9 MM
 TOP HEAD DIAM.- 15 MM
 BOTTOM HD DIAM.-20 MM
 OVERALL LENGTH-33 MM

3046

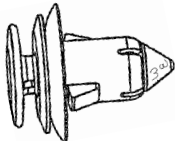

(06505918AA)
**DOOR TRIM PANEL CLIP
 YELLOW HEAD**
 CHRYS. MINIVANS-'01 & UP
 UNIT PKG.-25

HOLE SIZE-9 MM
 TOP HEAD DIAM.- 15 MM
 BOTTOM HD DIAM.-20 MM
 OVERALL LENGTH-21 MM

3047

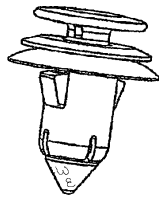

**DOOR TRIM PANEL CLIP
 GREEN HEAD**
 CHRYS. VANS-'01 & UP
 UNIT PKG.-25

HOLE SIZE-9 MM
 TOP HEAD DIAM.- 15 MM
 BOTTOM HD DIAM.-20 MM
 OVERALL LENGTH-26 MM

3048



**DOOR TRIM PANEL CLIP
 GREY HEAD**
 CHRYS. VANS-'01 & UP
 UNIT PKG.-25

HOLE SIZE-9 MM
 TOP HEAD DIAM.- 15 MM
 BOTTOM HD DIAM.-20 MM
 OVERALL LENGTH-26 MM

PLASTIC RETAINERS-INTERIOR / EXTERIOR, PUSH TYPE

3059

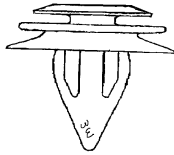

(01553-02821)
**DOOR PANEL RETAINER
 NISSAN MAXIMA**

UNIT PKG.-15

HOLE SIZE-8 MM
 OVERALL LENGTH-17 MM

3095

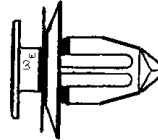

(90467-10188)
**DOOR TRIM PANEL RETAINER
 TOYOTA SIENNA-2004**

UNIT PKG.-25

HOLE SIZE-8.5 MM
 OVERALL HEIGHT- 20 MM

3114

(15076791)

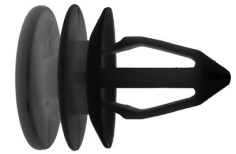

**PLASTIC DOOR TRIM PANEL
 RETAINER
 GM- S & T TRUCKS-2002 & UP**

UNIT PKG.-15

HOLE SIZE-9 MM
 TOP HEAD DIAM.-20 MM
 OVERALL LENGTH-26 MM

3228

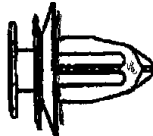

(90467-A0005)
**PLASTIC INTERIOR TRIM
 PANEL RETAINER
 WITH SEALER
 TOYOTA/LEXUS
 2001 & UP
 UNIT PKG.-15**

HOLE SIZE-8.5 MM
 OVERALL HEIGHT-20 MM
 TOP HD. DIAMETER-13 MM

3230

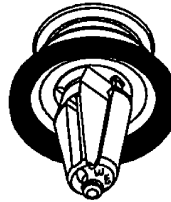

(W713297-S300)
**PLASTIC DOOR PANEL
 RETAINER WITH SEALER
 FORD-FUSION, FOCUS
 MERCURY MILAN- 2007 & UP
 UNIT PKG.-25**

HOLE SIZE-9 MM
 TOP HEAD-16 MM
 OVERALL HEIGHT-28 MM

3296

(11519031)



**PLASTIC DOOR PANEL
 RETAINER WITH SEALER
 GM-'03 & UP
 BUICK, CADILLAC, GMC, CHEVY,
 OLDS, HUMMER, PONTIAC,
 SATURN, & SAAB
 UNIT PKG.-15**

HOLE SIZE-9 MM
 TOP HEAD-19.5 MM
 OVERALL HEIGHT-26 MM

3299



(11519032)
**PLASTIC DOOR PANEL
 RETAINER WITH SEALER
 (BUICK, CADILLAC, GMC, CHEVY,
 OLDS, HUMMER, PONTIAC)
 GM-2002 & UP
 UNIT PKG.-10**

HOLE SIZE-9 MM
 TOP HEAD-19.5 MM
 OVERALL HEIGHT-28 MM

3315

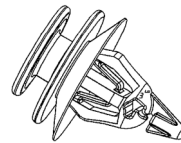

(11561654)
**PLASTIC INTERIOR
 TRIM RETAINER
 GM-BUICK, CADILLAC
 & CHEVY
 2006 & UP
 UNIT PKG.-15**

HOLE SIZE-8.5 MM
 TOP HD. DIAM.-13MM
 OVERALL LENGTH-22 MM

3318

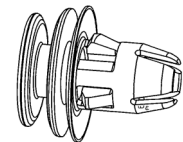

(68061648-AA)
**PLASTIC TAILLAMP
 RETAINER
 CHRYS/DOGE-RAM TRUCKS
 2009 & UP**

UNIT PKG.-15

HOLE SIZE-9.5 MM
 TOP HEAD DIAM.-15 MM
 OVERALL LENGTH-20 MM

PLASTIC RETAINERS- PUSH TYPE

3344



(13252118, REPL. 11610605)
PLASTIC DOOR PANEL RETAINER
 GM-CHEVY, BUICK, GMC, SAAB
 & CADILLAC- 2010-UP
UNIT PKG.-25

HOLE SIZE-7 MM
 TOP HEAD DIAM.-13 MM
 LOWER HD DIAM.-17 MM
 O/A HEIGHT 21 MM

3345

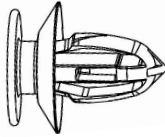

(11610606, REPL. 13252119)
PLASTIC DOOR PANEL RETAINER
 GM, BUICK, GMC & SAAB
 2010-UP
UNIT PKG.-25

HOLE SIZE-7 MM
 TOP HEAD DIAM.-15 MM
 LOWER HD DIAM.-17 MM
 O/A HEIGHT 21 MM

3377

(22718369)

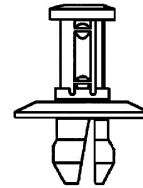

PLASTIC PUSH RIVET
FRONT AIR DEFLECTOR AND
FUEL TANK SHIELD RETAINER
 CHEVY, CADILLAC, BUICK
 GM & GMC/PICKUP
 2007-UP
UNIT PKG.-25

HOLE SIZE-10 MM
 FLANGE DIAM.-26 MM
 STEM LENGTH-13 MM

2216

(AMC/JEEP- 6503454)
 (FORD-E3D8-4A163CA)
 (AMC-8934-201-621)
 (CHRY.S.-34201621)
 (GM-14019205,14019206)
 (CHRY.S.-06504090)

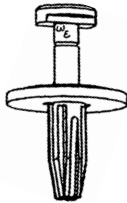

PLASTIC RIVET-MUD SKIRT
ATTACHING, OTHER USES
 GM, FORD & CHRYSLER
 '81 & UP
UNIT PKG.-50

HOLE SIZE-6.3 MM (1/4")
 FLANGE DIAM.-17.5 MM

2223

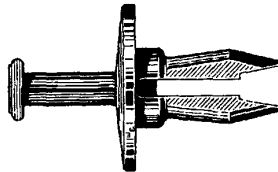

(5973400)
PLASTIC RIVET
FRONT & REAR BUMPER
ATTACHING STRIP
 GM- '81 & UP

UNIT PKG.-25

FLANGE DIAM.-1"; SHOULDER -1/8"

2388

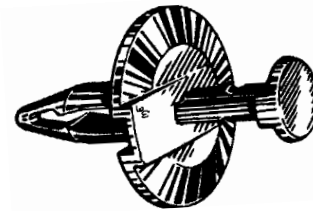

(14093088), (N802781S),
 (W704340-S300), (55176248)
DRIVE RIVET-BUMPER FASCIA
GENERAL USE
 GM, FORD & CHRYSLER
UNIT PKG.-25

HOLE SIZE-7 MM
 HD. DIAM.-25 MM

2398

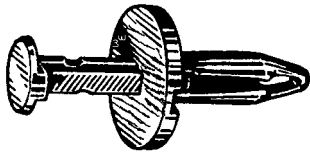

(REPLACES-10134407)
 (20510029), (20590899), (N803362),
 (008934202672)
 (REPLACES-CHRY.S.-6501925)

PLASTIC DRIVE RIVET
 GM, FORD, AMC & CHRYSLER
UNIT PKG.-25

HOLE SIZE-6.3 MM
 HD. DIAM.-17.5 MM

2399

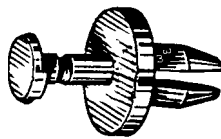

(14071289), (04388293),
 (175720B010)

PLASTIC DRIVE RIVET
 GM, FORD & CHRYSLER

UNIT PKG.-25

HOLE SIZE-8 MM
 HD. DIAM.-17 MM

2413



(6500787), (16500308),
 (W705581-S300)
NYLON DRIVE RIVET
INTERIOR TRIM & TAIL LAMP
RETAINER

HOLE SIZE-5 MM (3/16")
 BASE HD. DIAM.-7.2 MM
 PIN HD. DIAM.- 9.5 MM

GM, CHRYSLER & FORD
UNIT PKG.-15



PLASTIC RETAINERS- PUSH TYPE

2104

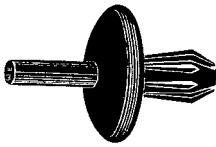

(383142-S)
**PLASTIC RIVET-GRILLE TO
 HEADLAMP BRACKET
 FORD & UNIVERSAL**

UNIT PKG.-50

HOLE SIZE-1/4"
 HEAD DIAM.-5/8"

2420

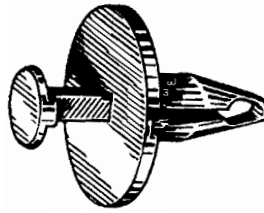

(N804614-S), (N803934-S)
 (20570245), (W701054-5300)
**PUSH TYPE RIVET
 FORD-TAURUS & SABLE; GM**
UNIT PKG.-25

HOLE SIZE-8 MM
 FLANGE DIAM.-25 MM

2437

(22535007)

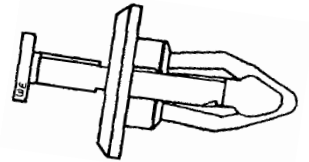

**PUSH TYPE RIVET
 BUMPER FASCIA
 GM- '87 & UP**
UNIT PKG.-25

HOLE SIZE-9.5 MM
 SHOULDER DIAM.-12.7 MM
 FLANGE DIAM.-25 MM
 PANEL RANGE-7-10 MM

2438

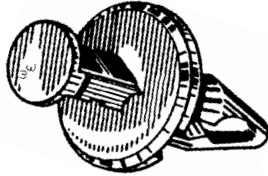

(14103461)
**PUSH TYPE BUMPER
 FASCIA RIVET
 GM-'87 & UP**
UNIT PKG.-25

FOR 9.5MM HOLE; FLNG DIA. 22MM
 SHOULDER DIAM.-12.7 MM
 PANEL RANGE-4-10 MM

2453

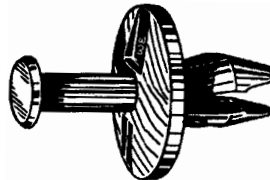

(14045480), (55074801)
**PLASTIC FASCIA RETAINER
 (NO SHOULDER)
 GM & CHRYSLER**
UNIT PKG.-25

HOLE SIZE-8MM; HD. DIAM.-25 MM
 PANEL RANGE-UP TO 6.3 MM

2458

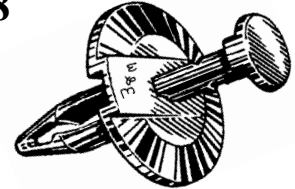

(N803421S), (0650590)
**SPLASH SHIELD/ FASCIA
 RETAINER
 FORD & CHRYSLER**
UNIT PKG.-25

HOLE SIZE-6 MM; SHOULDER -8 MM

2478

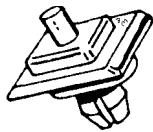

(90678-SAO-003)
 (90853-671-003)
**PLASTIC DRIVE RIVET-
 HONDA**

UNIT PKG.-15

HOLE SIZE-8 MM
 HD.DIAM.-12 X 18 MM
 SHOULDER-2 MM

2550

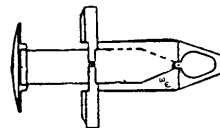

(CHRYSLER-6503598)
 (GM-21030249,15969147)
 (FORD-807389S)
**NYLON PUSH RIVET
 GM (SATURN), C, K TRUCK,
 FORD & CHRYSLER**

UNIT PKG.-25

HOLE SIZE-8MM
 HD.DIAM.-20MM
 PANEL RANGE-3-8 MM

2551

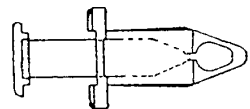

(GM-21075686,11561878;
 FORD-F3LY-14570-B)

NYLON PUSH RIVET

**GM (SATURN, TRUCK);
 FORD**

UNIT PKG.-25

HOLE SIZE-8MM
 HD.DIAM.-15MM
 PANEL RANGE-3-8 MM

PLASTIC RETAINERS- PUSH TYPE

2599

(01553-06721)

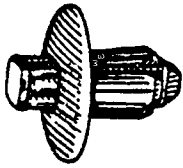

**PUSH RIVET
BUMPER COVER
NISSAN MAXIMA
INFINITY
UNIT PKG.-15**

HOLE SIZE-8 MM
HD. DIAM.-20 MM

2612



(68814-01G00)
**PUSH RIVET-COWL
GRILLE RETAINER
NISSAN TRUCKS
'86 & UP
UNIT PKG.-25**

HOLE SIZE-5 MM
(SQUARE HOLE)

2614

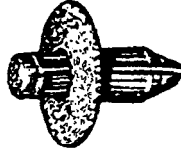

(NISSAN-809905N07),
(01553-00755)
(TOYOTA-90467-07043)
**BUMPER PUSH RIVET
UNIT PKG.-15**

HOLE SIZE-7 MM
HD. DIAM.-18 MM

2617



(66824-01G00)
**PUSH RIVET NISSAN
UNIT PKG.-15**

HOLE SIZE-6 MM
HD. DIAM.-12 MM

2615



(HONDA- 91545-SEO-0030-W1)
(NISSAN-63848-01G00)

**PUSH RIVET-HONDA, NISSAN
UNIT PKG.-15**

HOLE SIZE-8 MM
HD.DIAM.-20MM

2701

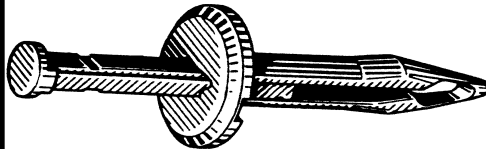

(15959832)
**PLASTIC DRIVE RIVET
LICENSE PLATE BRACKET
RETAINER
GM TRUCKS**

UNIT PKG.-5

HOLE SIZE-10 MM; HD. DIAM.-25 MM
SHOULDER-12.7 MM; STEM-41 MM

3431

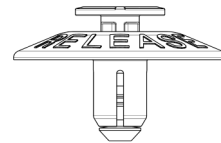

(W717823-S300)
**PLASTIC PUSH RIVET
FENDER LINER RETAINER**

(FOR 6.5 MM HOLE; 25 MM
FLANGE DIAM.; 9 MM STEM
LENGTH)

**FORD- MUSTANG
2015-UP**

UNIT PKG.-15

2699

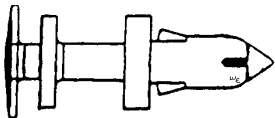

(15960325)
**DOOR PANEL RETAINER
PUSH RIVET
GM TRUCKS- '95 & UP
UNIT PKG.- 25**

HOLE SIZE-7 MM
TOP HD.DIAM.-16 MM
OVERALL LENGTH-35 MM

2717

(4630253)

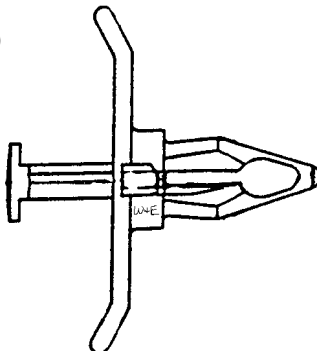

**PLASTIC DRIVE RIVET-REAR
FASCIA TO QUARTER PANEL
CHRYSLER-1993 & UP
UNIT PKG.- 15**

2729

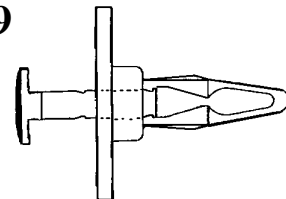

(GM-22587036)
**PLASTIC DRIVE RIVET
FRONT & REAR
BUMPER COVERS
'95- CHEVY CAVALIER
& PONTIAC SUNFIRE
UNIT PKG.- 25**

HOLE SIZE-3/8"; HD. DIAM.-1"
SHOULDER HT.-5/32"

PLASTIC RETAINERS- PUSH TYPE

2739

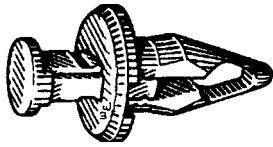

(10157900)
(REPLACES-15993201)
**PUSH TYPE PLASTIC RIVET
BUMPER FASCIA
FRONT/REAR
GM-SATURN & OLDS-'90 & UP
UNIT PKG.-25**

HOLE SIZE-9.5 MM; HD. DIAM.-
18 MM ;PANEL RANGE-4-7 MM

2757

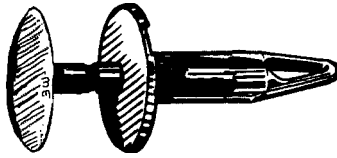

(21095797)
**PLASTIC DRIVE RIVET
REAR BUMPER
GM SATURN-'96 & UP
UNIT PKG.-15**

HOLE SIZE-8 MM; HD. DIAM.-20 MM

2883

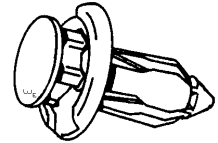

(91503-SZ3-003)
(REP.-91503-S7A-003)
**PLASTIC PUSH RIVET
FRONT GRILLE & BUMPER
HONDA- '96 & UP
UNIT PKG.-10**

HOLE SIZE-10 MM
FLANGE O.D.-20 MM
STEM-13 MM

2885



(REP.-52161-02020)
(52161-16010)
**PLASTIC PUSH RIVET
REAR BUMPER COVER
RETAINER
TOYOTA-TERCEL-'88 & UP
UNIT PKG.-5**

HOLE SIZE-9 MM;
HD. DIAM.-18 MM
STEM LENGTH-28 MM

2886



(91501-SO4-003)
**PLASTIC PUSH RIVET
FRONT FENDER LINER
HONDA-CIVIC & DEL SOL
'93 & UP
UNIT PKG.-10**

HOLE SIZE-8 MM; HD. DIAM.-20 MM

2887

(15149708)
(6506008AA)

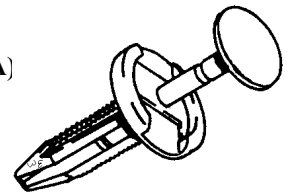

**PUSH RIVET
RETAINER-RADIATOR
FENDER & WHEELHOUSE
GM C,K TRUCK- '99 & UP
UNIT PKG.-25**

HOLE SIZE-6 MM
HEAD DIAM.-17 MM

2889

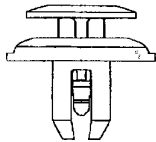

(HONDA 91512-SXO-003)
(MITSUBISHI MU000319)
(GM11519949)
**PLASTIC PUSH RIVET
FRONT FENDER & BUMPER
HONDA/ ACURA-'94 & UP
MITSUBISHI-'02 & UP
GM/GMC-'07-UP
UNIT PKG.-25**

HOLE SIZE-8MM
HEAD DIAM.-20MM
OVERALL LENGTH- 13.4 MM

2898

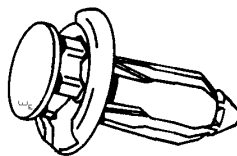

(91503-SZ5-003)
**PLASTIC PUSH RIVET
FRONT GRILLE AND BUMPER
HONDA- '98 & UP
UNIT PKG.-10**

HOLE SIZE-10 MM
FLANGE OD-20 MM
STEM-17 MM

2902

(21077123)
(W705436-S300)

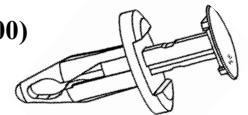

**NYLON PUSH RIVET
WHEEL OPENING, COWL VENT
& BUMPER COVER
GM-(SATURN), FORD
UNIT PKG.-25**

HOLE SIZE-6.3 MM
FLANGE OD-15 MM
PANEL RANGE-2-6 MM

PLASTIC RETAINERS- PUSH TYPE

2912

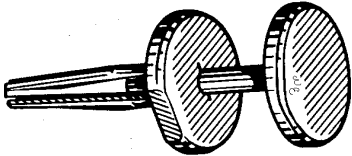

(6503106)
PLASTIC PUSH RIVET
LOWER MOULDING
LIC.PLA TE BRACKET
CHRYSLER JEEP- '93 & UP
UNIT PKG.-15

HOLE SIZE-6.3 MM
 HD. DIAM.-22 MM

2931

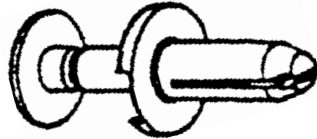

(CHRYSLER/DODGE-6504521)
PLASTIC DRIVE RIVET
FRONT & REAR FASCIA
'98-UP
UNIT PKG.-25

HOLE SIZE-8.5 MM
 HD.DIAM.-16 MM
 STEM LENGTH-23 MM

2932

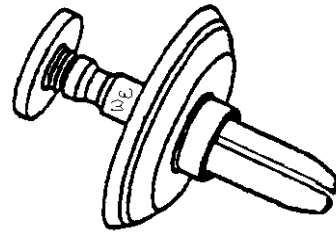

(4805405AA)
PLASTIC DRIVE RIVET
FRONT BUMPER FASCIA
CHRYSLER-CONCORD & INTREPID
UNIT PKG.-15

HOLE SIZE-8.5 MM
 HD.DIAM.-34 MM;STEM LENGTH- 22 MM

2953

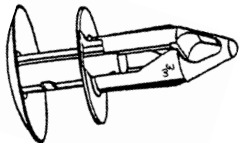

(15153415)
PLASTIC PUSH RIVET
REAR BUMPER COVER
GM C, K TRUCKS-'99 & UP
UNIT PKG.-25

HOLE SIZE-8.5 MM
 HEAD. DIAM.-20 MM
 FLANGE O.D.-17 MM

2958

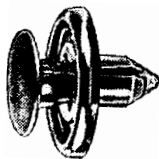

(90467-07166)
PUSH TYPE RETAINER
FRONT FENDER
TOYOTA TERCEL-'94 & UP
UNIT PKG.-15

HOLE SIZE-7 MM
 HD. DIAM.-20 MM,STEM-8 MM

2959



(01553-09321)
PUSH TYPE RETAINER
FRONT FENDER
NISSAN MAXIMA, 300ZX-'94 & UP
UNIT PKG.-15

HOLE SIZE-8 MM
 HEAD. DIAM.-20 MM
 STEM-9 MM; PANEL RANGE-4 MM

2974

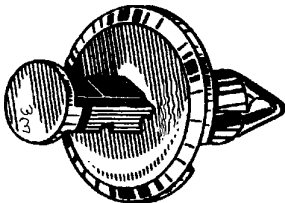

(10077283)
PLASTIC DRIVE RIVET
BUMPER FASCIA
GM- '82 & UP

UNIT PKG.-25

HEAD DIAM.-1"
 SHOULDER DIAM.-1/2"

2985



(21035345)
BLACK PLASTIC PUSH RIVET
MOULDING RETAINER
GM (SATURN)- '93 & UP

UNIT PKG.-10

HOLE SIZE-7 MM
 HD.DIAM.-16 MM
 STEM LENGTH- 12 MM

2986

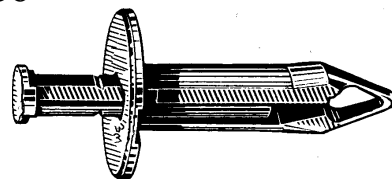

(21077131)
PLASTIC DRIVE RIVET
BUMPER FASCIA
GM-'91 & UP
UNIT PKG.-10

HOLE SIZE-7/16"
 HD.DIAM.-1-3/16"
 STEM LENGTH- 2"

PLASTIC RETAINERS- PUSH TYPE

2987

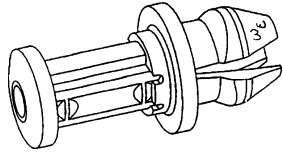

(XL3Z-17E971-AA; XL34-17E971-AA)
**PLASTIC DRIVE RIVET
 FRONT BUMPER COVER
 FORD TRUCKS
 '99 & UP
 UNIT PKG.-25**

HOLE SIZE-10 MM; HD.DIAM.-16 MM
 STEM LENGTH-12.5 MM

2991

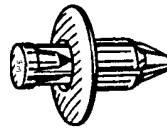

(TOYOTA-90467-07076-CO)
**REPL.(GEO 96057846)
 PUSH RIVET-COWL &
 EXTERIOR TRIM
 TOYOTA AVALON-2000 & UP
 SIENNA-1998 & UP
 GEO METRO/TRACKER-'89 & UP
 UNIT PKG.-10**

HEAD DIAMETER-15 MM
 STEM LENGTH-13 MM
 FOR 6.3 MM HOLE

3018

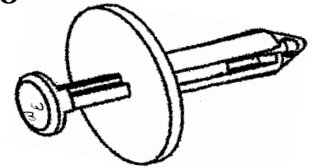

(622A2-9E000;11561874)
**PLASTIC PUSH RIVET
 BUMPER COVER RETAINER
 NISSAN ALTIMA; GM-'97 & UP
 UNIT PKG.-10**

HOLE SIZE-7 MM
 HEAD DIAM-25 MM
 OVERALL LENGTH-32 MM

3019

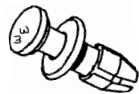

(HONDA-90657-SBO-0030)
**(REPL.91533-SG0-0000)
 PLASTIC PUSH RIVET
 BUMPER COVER,
 SPLASH SHIELD & FENDER SEAL
 HONDA - ACCORD, ODYSSEY,
 PRELUDE; ACURA - LEGEND
 1991 & UP
 UNIT PKG.-10**

HOLE SIZE-8 MM
 FLANGE O.D.-11 MM
 STEM LENGTH-10 MM

3023

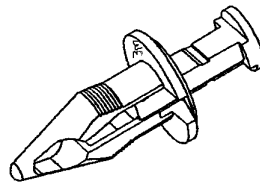

(11519444;11517803)
**PLASTIC PUSH RIVET
 BUMPER COVER RETAINER
 GM-'97 & UP
 UNIT PKG.-25**

HOLE SIZE-10 MM
 HEAD. DIAM.-18 MM
 STEM-26 MM
 PANEL RANGE-6.2-8.7 MM

3038

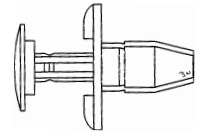

(10301966;10425306)
**NYLON PUSH RIVET
 COWL PANEL RETAINER
 GM "U" VAN, CHEVY,
 PONTIAC, OLDSMOBILE
 & BUICK -2001 & UP
 UNIT PKG.-10**

HOLE SIZE-8 MM
 HEAD DIAM.-18 MM

3040

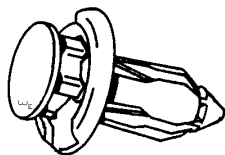

(01553-09241)
**(Repl. SUBARU-57728-AC-090)
 PLASTIC PUSH
 RIVET RETAINER
 FRONT GRILLE AND BUMPER
 NISSAN- '94 & UP
 UNIT PKG.-10**

HOLE SIZE-10 MM
 HEAD DIAM-18 MM
 STEM LENGTH-15 MM

3078

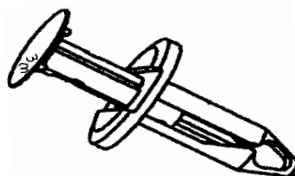

(GM-11518017)
**(FORD-W 708530-S300)
 PLASTIC PUSH RIVET
 BUMPER COVER & FENDER SHIELD
 GM & FORD-'97 & UP
 UNIT PKG.-25**

HOLE SIZE-8 MM
 FLANGE DIAM.-20MM
 PANEL RANGE-3- 12 MM

3079

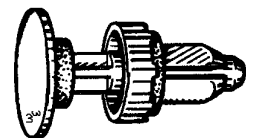

(91508-SM4-003)
**PLASTIC PUSH RIVET
 COWL PANEL
 HONDA ACCORD-'90 & UP
 ACURA- '96 & UP
 UNIT PKG.-10**

HOLE SIZE-8 MM
 HEAD DIAM.-18 MM

PLASTIC RETAINERS- PUSH TYPE

3093

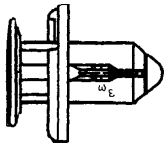

(01553-09611)
PLASTIC PUSH RIVET
GRILLE & BUMPER FASCIA
NISSAN- '94 AND UP
UNIT PKG.-15

HOLE SIZE-8 MM
HEAD DIAMETER-18 MM
STEM LENGTH-10 MM

3109

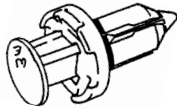

(MR 200300)
PLASTIC PUSH RIVET
BUMPER COVER &
TRIM RETAINER
HONDA, MITSUBISHI,
CHRYSLER-'97 & UP

UNIT PKG.-15

HOLE SIZE-9 MM
FLANGE DIAMETER-18 MM
STEM LENGTH-13 MM

3132



(25695687)
REUSABLE PLASTIC PUSH RIVET
RADIATOR SUPPORT
& SIGHT SHIELD
CADILLAC 2000 & UP
UNIT PKG.-10

HOLE SIZE-9 MM
HD.DIAM.-27 MM
PIN LENGTH-26 MM

3133

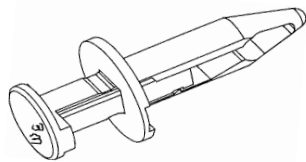

(15994165)
PLASTIC PUSH RIVET
BUMPER & REAR WHEEL SKIRT
GM- SATURN "L" SERIES-2000-UP
UNIT PKG.-25

HOLE SIZE-8 MM
HD.DIAM.-16.5 MM
STEM LENGTH-27 MM

3171

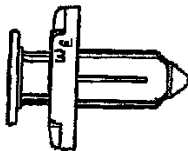

(11296-AG000)
PLASTIC PUSH RIVET
BUMPER & RADIATOR
NISSAN- 2002 & UP
UNIT PKG.-25

HOLE SIZE-8 MM
HD. DIAM.-20 MM
STEM:-13 MM

3182

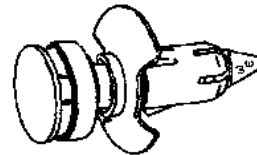

(W704958-S300)
PLASTIC PUSH RIVET
LOWER DOOR TRIM
FORD/LINCOLN TOWN CAR
1998 & UP
UNIT PKG.-10

HOLE SIZE-9 MM
FLANGE-23 MM
OVERALL LENGTH-33 MM

3187

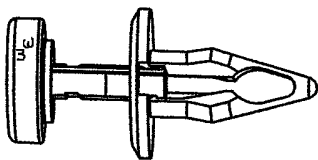

(4857345-AA)
PLASTIC PUSH RIVET
TAIL LAMP HOUSING RETAINER
CHRYSLER-DODGE MINIVANS
2002 & UP

UNIT PKG.-25

HOLE SIZE-9.5 MM
BASE HD.DIAM.-21 MM
STEM LENGTH-23 MM

3194

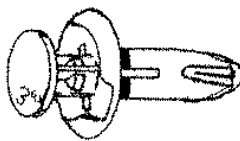

(90505-SX0-003)
PLASTIC PUSH TYPE RIVET
GARNISH MOULDING
RETAINER
HONDA-CRV & ODYSSEY
2002 & UP

UNIT PKG.-20

HOLE SIZE-8 MM
HEAD DIAM.-18 MM
STEM LENGTH-15 MM

3202

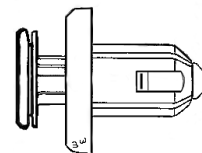

(91505-S9A-0032)
PLASTIC BUMPER
COVER RETAINER-
(WITH METAL INSERT)
HONDA-ACCORD, CIVIC,
CRV & ELEMENT-
ACURA 2006 & UP

UNIT PKG.-10

HOLE SIZE-10 MM
FLANGE DIAM.-20 MM
PIN LENGTH-25.5 MM

PLASTIC RETAINERS— PUSH TYPE

3210

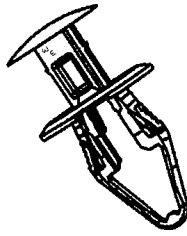

(11561368, 6508712)
**PLASTIC PUSH RIVET
 FENDER LINER RETAINER
 GM, CHRYSLER- 2006 & UP
 UNIT PKG.-25**

HOLE SIZE-9.5 MM
 HEAD DIAM.-18 MM
 BASE STEM LENGTH-20 MM

3212

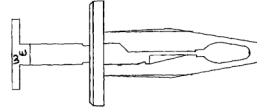

(GM-15681408, 25642453)
 (FORD-N803709)
 (CHRYSLER-4857108)
**PLASTIC FASCIA RETAINER
 GM, FORD & CHRYSLER
 1986 & UP
 UNIT PKG.-25**

HOLE SIZE-6.3 MM
 HEAD DIAM.-15 MM
 STEM LENGTH-23 MM

3214

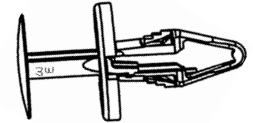

(11589290)
**PLASTIC PUSH RIVET
 COWL VENT &
 BUMPER FASCIA RETAINER
 GM- 2002 & UP
 UNIT PKG.-50**

HOLE SIZE-6.5 MM
 HEAD DIAM.-18 MM
 STEM LENGTH-20 MM

3215

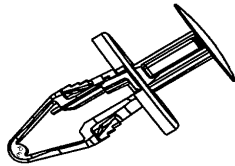

(11589293;W712916-
 S300;68003844AA)
**PLASTIC PUSH RIVET
 COWL VENT &
 FENDER LINER RETAINER
 GM;FORD;CHRYSLR- 2004 & UP
 UNIT PKG.-25**

HOLE SIZE-8.5 MM
 HEAD DIAM.-20 MM
 STEM LENGTH-22 MM

3216

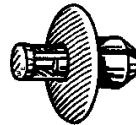

(90467-07117)
**PLASTIC PUSH RIVET
 SEAL RETAINER,
 RADIATOR, BUMPER & COWL
 TOYOTA-LEXUS
 1990 & UP
 UNIT PKG.-10**

HOLE SIZE-7 MM
 HEAD DIAM.-17 MM
 STEM LENGTH-8 MM

3224

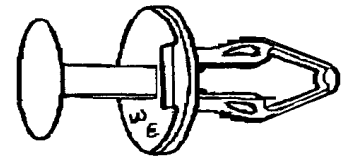

(11589294)
**PLASTIC PUSH RIVET
 RADIATOR SITE SHIELD
 RETAINER, HOOD BRACKET
 GM-2007 & UP
 UNIT PKG.-25**

HOLE SIZE-8.5 MM
 HEAD DIAM.-20 MM
 STEM LENGTH-24 MM

3229

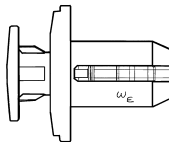

(91503-S0K-A01)
**PLASTIC PUSH RIVET GRILLE &
 AIR DEFLECTOR RETAINER
 HONDA CIVIC, PILOT, &
 ELEMENT-'03-'08
 UNIT PKG.-15**

HOLE SIZE-10 MM
 HD. DIAM.-20 MM; STEM-14 MM

3232



(53879-60010)
**PLASTIC PUSH RIVET
 FENDER LINER
 TOYOTA-LAND CRUISER, RAV 4
 LEXUS-LX 470- 1998 & UP
 UNIT PKG.-10**

HOLE SIZE-7 MM
 HEAD DIAMETER-18 MM
 STEM LENGTH-7 MM

3235



(52161-20010)
**PLASTIC PUSH RIVET
 BUMPER COVER
 TOYOTA-2000 & UP
 (LONGER THAN W&E #2885)
 UNIT PKG.-10**

HOLE SIZE-9 MM
 FLANGE DIAMETER-18 MM
 BASE LENGTH-35 MM

PLASTIC RETAINERS- PUSH TYPE

3242



(OE-91505-ST7-003ZA)
(OE 90467-08180)
PLASTIC PUSH RIVET
HONDA 2000 & UP
TOYOTA 2004 & UP
UNIT PKG.- 10

HOLE SIZE-8 MM
FLANGE DIAM.-17 MM
PIN LENGTH-26 MM

3244

(6506132AA)

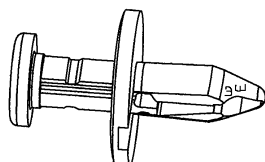

PLASTIC PUSH RIVET-FENDER
LINER & RADIATOR SHIELD
RETAINER, CHRYSLER-300,
SEBRING & STRATUS-2001 & UP
UNIT PKG.- 25

HOLE SIZE-7 MM
FLANGE-20 MM
OVERALL LENGTH-33 MM

3245

(11589289)
(6508863AA)
(W610713S300)

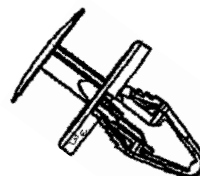

PLASTIC PUSH RIVET-INTERIOR
TRIM, RADIATOR, SIDE SHIELD,
& AIR DEFLECTOR RETAINER
GM, FORD, CHRYSLER-2002 & UP
UNIT PKG.- 25

HOLE SIZE-6.5 MM
FLANGE-18 MM
OVERALL LENGTH-31 MM

3246

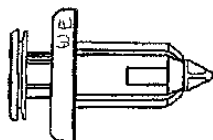

(91506-S9A-003)
PLASTIC PUSH RIVET
W/METAL INSERT GRILLE,
BUMPER COVER, FENDER
LINER & SPLASH SHIELD
(LONGER THAN W & E # 3202)
HONDA/ACURA-2006 & UP
UNIT PKG.- 10

HOLE SIZE-10 MM
HEAD DIAM.-20 MM
PIN LENGTH-30 MM

3254



(90467-07211)
PLASTIC PUSH RIVET
RADIATOR SEAL, SIGHT
SHIELD, & GRILLE RETAINER
TOYOTA/LEXUS-2005 & UP
UNIT PKG.-10

HOLE SIZE-7 MM
FLANGE-19 MM
OVERALL PIN LENGTH-18 MM

3260

(5116530AA)
(GM-15296830)
(W714415-S300)

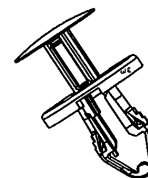

PLASTIC PUSH RIVET
BUMPER COVER & DOOR
GM, FORD, CHRYSLER-'07 & UP
UNIT PKG.- 25

HOLE SIZE-8 MM
HEAD DIAM.-19 MM
STEM LENGTH-16 MM

3263

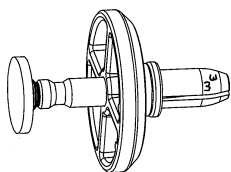

(4806334AA)
PLASTIC PUSH RIVET
W/SEALER, BUMPER
COVER RETAINER
CHRYSLER, JEEP
'07 & UP
UNIT PKG.- 10

HOLE SIZE-8.5 MM
HEAD DIAMETER-34 MM
STEM -17 MM, SHOULDER-11 MM

3273

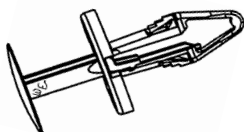

(11589291)
(W713331-S300)
PLASTIC PUSH RIVET
ROCKER MOULDING,
RADIATOR SIGHT SHIELD,
BUMPER COVER
GM, FORD 2006 & UP
UNIT PKG.- 25

HOLE SIZE-6.5 MM
HEAD DIAM.-18 MM
STEM LENGTH- 22 MM

3275



(91561-SJD-003)
PLASTIC PUSH RIVET
INTERIOR TRIM, PILLAR, FLOOR,
ROCKER PANEL RETAINER
HONDA CIVIC & PILOT
ACURA-MDX-2004 & UP
UNIT PKG.- 10

HOLE SIZE-8.5 MM
TOP HEAD DIAM.-15 MM
OVERALL PIN LENGTH- 38 MM

PLASTIC RETAINERS- PUSH TYPE

3285

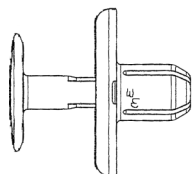

(90467-07214)
**BLACK PLASTIC PUSH RIVET
 RADIATOR SPLASH SHIELD
 RETAINER
 TOYOTA CAMRY-2007 & UP
 UNIT PKG.- 20**

HOLE SIZE-7 MM
 HEAD DIAM.-20 MM
 OVERALL BASE HEIGHT- 12 MM

3295



(90467-07201)
**PLASTIC PUSH RIVET
 ENGINE UNDER COVER
 TOYOTA/LEXUS
 2002 & UP
 UNIT PKG.-10**

HOLE SIZE-7 MM
 HEAD DIAM.-20 MM
 STEM LENGTH- 10 MM

3304



(90467-07164)
**PLASTIC PUSH RIVET
 FENDER LINER, &
 SPLASH SHIELD
 TOYOTA/LEXUS- 2002 & UP
 UNIT PKG.-10**

HOLE SIZE-7 MM
 HEAD DIAM.-20 MM
 STEM LENGTH- 10 MM

3306

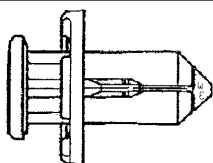

(90914-0007)
**PLASTIC PUSH RIVET RETAINER
 FENDER LINER, BUMPER COVER
 & GRILLE
 SUBARU-2005 & UP
 UNIT PKG.-10**

HOLE SIZE-10 MM
 HEAD DIAM.-21 MM
 OVERALL LENGTH- 29 MM

3307

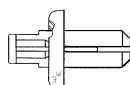

(90914-0059)
**PLASTIC PUSH RIVET
 RETAINER, BUMPER COVER
 SUBARU FORESTER &
 IMPREZA- 2008 & UP
 UNIT PKG.-10**

HOLE SIZE-5 MM
 HEAD DIAM.-10 MM
 OVERALL BASE HT.- 11 MM

3326

(GM 11589295)
 (FORD
 W712665-S300)



**PLASTIC PUSH RIVET-FUEL
 TANK SHIELD, BUMPER COVER,
 FENDER SHIELD, & INT. PANELS
 GM & GMC PICK-UP'S
 CHEVY-COBALT & HHR
 C/K TRUCKS-PONTIAC G5 & G6
 UNIT PKG.- 25**

HOLE SIZE-10.5 MM
 25 MM HEAD DIAMETER
 3-6 MM PANEL THICKNESS

3327

(11589296)

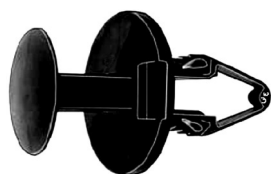

**BLACK PLASTIC PUSH RIVET
 BUMPER COVER & GENERAL
 PANEL ATTACHMENT
 GM-BUICK ENCLAVE
 GMC-ACADIA- 2008 & UP
 UNIT PKG.-25**

HOLE SIZE-10.5 MM
 HEAD DIAM.-25 MM
 6-9 MM PANEL THICKNESS

3367



(11609417)
**PLASTIC PUSH RIVET
 FENDER LINER RETAINER
 GM-CADILLAC & SUV'S
 2003-UP
 UNIT PKG.-25**

HOLE SIZE-8.5 MM
 HEAD DIAM.-19 MM
 STEM LENGTH- 14 MM

3369

(W710250-S300)



**PLASTIC SCREW RIVET
 BUMPER COVER & ROCKER
 MOULDING RETAINER
 FORD EDGE & EXPLORER
 LINCOLN MKS, MKT & MKX
 2008-UP
 UNIT PKG.-20**

HOLE SIZE-8 MM
 HEAD DIAM.-18 MM
 STEM LENGTH- 18 MM

PLASTIC RETAINERS- PUSH/ SCREW TYPE

3308



(90467-10183), (88970767)
PLASTIC PUSH RIVET
FENDER LINER
TOYOTA/LEXUS- 2007 & UP
GM-PONTIAC VIBE
UNIT PKG.-10

HOLE SIZE-7 MM
 HEAD DIAM.-18 MM
 STEM LENGTH- 7 MM

3346

(01553-05323)



PLASTIC PUSH RIVET
ROCKER MOULDING, FENDER LINER,
RADIATOR SPLASH SHIELD,
& INTERIOR TRIM PANEL
INFINITY & NISSAN 2003 & UP
UNIT PKG.-10

HOLE SIZE-8 MM
 HEAD DIAM.-20 MM
 STEM LENGTH- 12 MM

3362

(90467-07188)



PLASTIC PUSH RIVET
FENDER LINER AND
MUD FLAP RETAINER
TOYOTA-CAMRY,
4-RUNNER & TACOMA-2002-UP
UNIT PKG.-15

HOLE SIZE-7 MM
 HEAD DIAM.-15 MM
 STEM LENGTH- 17 MM

3371

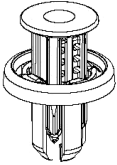

(91505-TM8-0030)
PLASTIC PUSH RIVET-GRILLE
& BUMPER COVER RETAINER
HONDA-ACCORD, INSIGHT
& CROSSTOUR-2012-UP
UNIT PKG.-15

HOLE SIZE-10 MM
 FLANGE DIAM.-20 MM
 STEM LENGTH-14 MM

3372

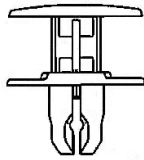

(91501-TR0-003)
PLASTIC PUSH RIVET
FENDER LINER & GRILLE CLIP
HONDA/ACURA-RDX, CIVIC
& ACCORD-2012-UP
UNIT PKG.-25

HOLE SIZE-8 MM
 HD.DIAM.-20 MM
 STEM LENGTH-10 MM

3382



(75867-06030)
PLASTIC PUSH RIVET
ROCKER MOLDING RETAINER
TOYOTA/LEXUS
AVALON, CAMRY, CAMRY HYBRID,
ES, & IS CONVERTIBLE-2012-UP
UNIT PKG.-10

HOLE SIZE-9 MM
 FLANGE DIAM.-20 MM
 STEM LENGTH-17 MM

2237

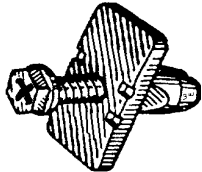

(GM-14013241;12337831)
 (CHRYSLER-4216535)
 (VW-175-853-695)
GRILLE ATTACHING SCREW
AND NUT-PLASTIC
UNIT PKG.-25

HOLE SIZE-9 MM (3/8")
 HEAD-14 X 26 MM

2361

(63844-01A00)

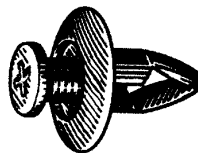

EXPANSION SCREW RIVET
INNER FENDER SHIELD
NISSAN & UNIVERSAL
UNIT PKG.-15

HOLE SIZE-8 MM; HD.DIAM.-20

2366

(90467-06017-20)

(9926-50-625)

(repl.90607-SA5-003)



EXPANSION SCREW RIVET
PANEL RETAINER
TOYOTA, MAZDA, & HONDA
UNIT PKG.-15

HOLE SZ-7 MM; FLANGE
 -15 MM; STEM- 12 MM

2405

(N803494S)

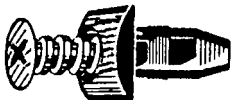

PLASTIC SCREW RIVET
FASCIA/GRILLE
FORD - '85 & UP
UNIT PKG.-25

HOLE SIZE-6 MM

2460

(GM-20664092)

(FORD- 804570S)

(W705848-S300)

(CHRYSLER-
 06502790)

TRIM RETAINER
GM, FORD, CHRYSL
UNIT PKG.-25

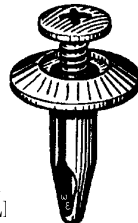

HOLE SIZE-6.3MM
 HD.DIAM.-18 MM

2415

(6502871), (N803946S)



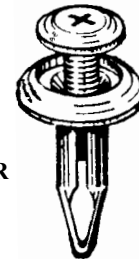

(W706350-S300), (20664091)

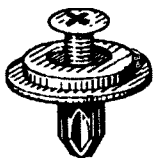
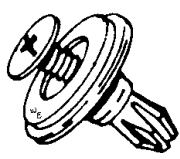
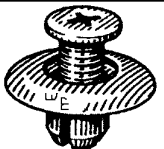
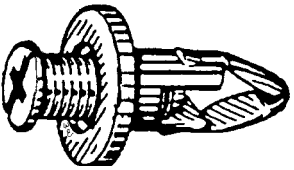
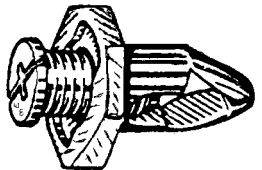
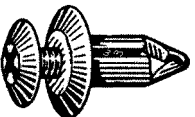
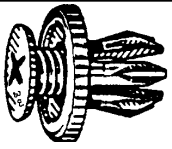
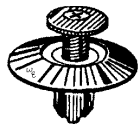
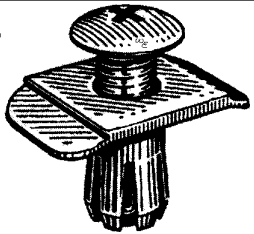

PLASTIC SCREW RIVET
EXT. COMPONENT RETAINER
FORD, GM & CHRYSLER
UNIT PKG.-25

HOLE SIZE-6.3 MM
 HD.DIAM.-16 MM

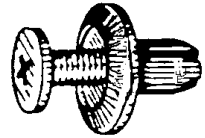
PLASTIC RETAINERS- SCREW TYPE

<p>2475</p>  <p>(90688-SB0-003) PLASTIC SCREW RIVET & COWL VENT HONDA UNIT PKG.-15</p> <div style="border: 1px solid black; padding: 2px; margin-top: 5px;"> <p>HOLE SIZE-6 MM;FLANGE-18 MM PANEL RANGE-2-6 MM</p> </div>	<p>2477</p>  <p>(01553-03101) BUMPER FASCIA RETAINER NISSAN- '86 & UP UNIT PKG.-15</p> <div style="border: 1px solid black; padding: 2px; margin-top: 5px;"> <p>HOLE SIZE-8 MM; HD.DIAM.-22 MM PANEL RANGE-2-10 MM SHOULDER DIAM.-11 MM</p> </div>	<p>2491</p>  <p>(90675-SB3-003), (90675-SB0-003) (63876-D5596), (FB01-56-964) NYLON SCREW RIVET HONDA, NISSAN, MAZDA UNIT PKG.-10</p> <div style="border: 1px solid black; padding: 2px; margin-top: 5px;"> <p>HOLE SIZE-8 MM HEAD DIAM.-20 MM</p> </div>
<p>2548</p>  <p>(91502-SM4-000) SCREW RIVET-BUMPER FASCIA HONDA -'90 & UP UNIT PKG.-10</p> <div style="border: 1px solid black; padding: 2px; margin-top: 5px;"> <p>HOLE SIZE-10 MM HD.DIAM.-20 MM; STEM-27 MM</p> </div>	<p>2549</p>  <p>(91504-SM4-000) SCREW RIVET-BUMPER FASCIA OCTAGONAL HEAD HONDA -'90 & UP UNIT PKG.-10</p> <div style="border: 1px solid black; padding: 2px; margin-top: 5px;"> <p>HOLE SIZE-10 MM</p> </div>	<p>2592 (66860-01W01)</p>  <p>SCREW RIVET- COWL PANEL TO REINFORCEMENT PLATE NISSAN UNIT PKG.-25</p> <div style="border: 1px solid black; padding: 2px; margin-top: 5px;"> <p>HOLE SIZE-6 MM HD.DIAM.-14 MM</p> </div>
<p>2609</p>  <p>(91503-SP0-00300;REPL. SUBARU-57728-FA020,-060) SCREW RIVET/BUMPER STRIP RETAINER ACURA-'91 & UP UNIT PKG.-10</p> <div style="border: 1px solid black; padding: 2px; margin-top: 5px;"> <p>HOLE SIZE-10MM; HD.DIAM.-20MM;STEM LENGTH-15MM</p> </div>	<p>2619</p>  <p>(NISSAN-80915-29A66, 23270-3895) (NISSAN-75775-41300) (MAZDA-1395-68-676, 9926-50-635) (ISUZU-8942431900, 8941690750) PLASTIC SCREW RIVET NISSAN, MAZDA, ISUZU UNIT PKG.-15</p> <div style="border: 1px solid black; padding: 2px; margin-top: 5px;"> <p>HOLE SIZE-6 MM HEAD DIAM.-20 MM</p> </div>	<p>2624</p>  <p>(01553-01393), (BF-82-50-233) BUMPER COVER CLIP NISSAN & MAZDA UNIT PKG.-5</p> <div style="border: 1px solid black; padding: 2px; margin-top: 5px;"> <p>HOLE SIZE-10 MM HEAD SIZE-20 X 30 MM</p> </div>
<p>2613 (90505-SM4-003) SCREW RIVET SILL PLATE MOULDING HONDA ACCORD '90 & UP</p>  <p>UNIT PKG.-10</p> <div style="border: 1px solid black; padding: 2px; margin-top: 5px;"> <p>HOLE SIZE-8 MM HEA DIAM.-18 MM</p> </div>	<p>2627 (10998-3880) (8942981190) (90684-SA5-0030)</p>  <p>PLASTIC SCREW RIVET NISSAN, HONDA, ISUZU UNIT PKG.-25</p> <div style="border: 1px solid black; padding: 2px; margin-top: 5px;"> <p>HOLE SIZE-6 MM; HEAD DIAM.-15 MM</p> </div>	<p>2655</p>  <p>(90467-09145) BUMPER COVER RETAINER-PUSH RIVET TOYOTA CAMRY UNIT PKG.-10</p> <div style="border: 1px solid black; padding: 2px; margin-top: 5px;"> <p>HOLE SIZE-9 MM; HD DIAM. 15 MM; STEM - 12 MM</p> </div>

PLASTIC RETAINERS- SCREW TYPE

2682

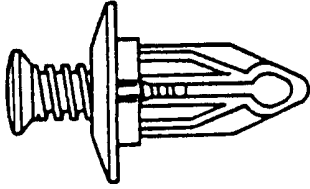

(GM-10140480)
(CHRY-06502625)
(FORD-309414, W708325S300)
SCREW RIVET-BUMPER/GRILLE
TRUCKS & VANS-'90 & UP
UNIT PKG.-25

FOR 6.4-6.9 MM HOLE
HEAD DIAMETER-18 MM
3-5 MM THICK PANEL

2686

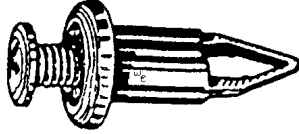

(90467-09093)
RETAINER- BUMPER COVER
TOYOTA & LEXUS
UNIT PKG.-10

HOLE SIZE-9 MM
HD.DIAM.-15 MM
STEM- 27 MM

2716



(OE-90657-SA6-0030)
(OE-N304-13-356A)
PLASTIC SCREW RIVET
HONDA, MAZDA
UNIT PKG.-25

HOLE SIZE-7 MM; HD.DIAM.-14 MM
STEM LENGTH-11 MM

2718

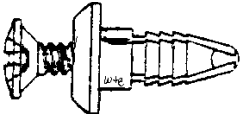

(GM-10195515)
(FORD-N805026S)
(CHRYSLER-4696488)
PLASTIC SCREW RIVET
UNIT PKG.-25

HOLE SIZE-17/64"; HD.DIAM.-1/2"
PANEL RANGE-17/32"-21/32"
LENGTH UNDER HEAD-1-13/64"

2719

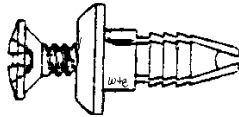

(6502573)
PLASTIC SCREW RIVET
CHRYSLER-'93 & UP
UNIT PKG.-15

HOLE SIZE-1/4" (SQUARE HOLE)
HEAD DIAM.-15/32"
LENGTH UNDER HEAD-37/64"

2758

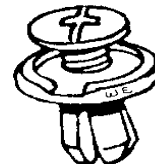

(91512-SM4-003)
SCREW RIVET
FENDER SPLASH SHIELD
HONDA ACCORD '90 & UP
UNIT PKG.-15

HOLE SIZE-8 MM
HD.DIAM.-20 MM
STEM LENGTH- 9 MM

2882

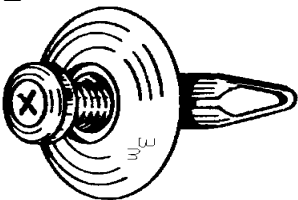

(N804837S)
PLASTIC SCREW RIVET
INTERIOR PANEL RETAINER
FORD-TAURUS/SABLE
UNIT PKG.-25

HOLE SIZE-1/4"; HD. DIAM.-1"

2884

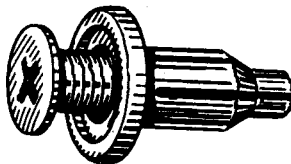

(91502-SPO-003)
PLASTIC SCREW RIVET
FRONT AND REAR BUMPER
HONDA-'90 & UP
UNIT PKG.-5

HOLE SIZE-10 MM
HD. DIAM.-20 MM

2897

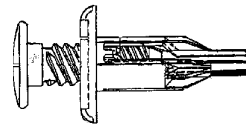

(91561-S84-A00-M1)
PLASTIC SCREW RIVET
HONDA
UNIT PKG.-10

HOLE SIZE-8MM
HD.DIAM.-16MM
P.R.3-7 MM
OVERALL LENGTH-24MM

PLASTIC RETAINERS— SCREW TYPE

2942

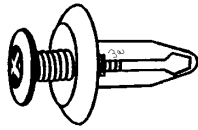

(96FG16K262AA)
SCREW RIVET
WHEELHOUSE LINER/ GRILLE
FORD FOCUS-2000-2001

UNIT PKG.-25

HOLE SIZE-6 MM
HD. DIAM.-16 MM; STEM-18 MM

2977

(10053182)
(W706264S300)
(6503163)

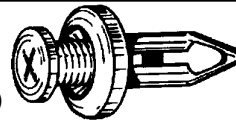

PLASTIC SCREW RIVET
COWL, DOOR TRIM, BUMPER
COVER, SPLASH SHIELD
GM, FORD & CHRYSLER-'88 & UP
UNIT PKG.-25

HOLE SIZE-8- 8.5 MM
HEAD DIAM.-15 MM

3013

(W706713-S300)

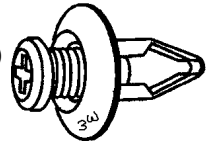

PLASTIC SCREW RIVET
BUMPER COVER RETAINER
FORD ESCAPE-2001 & UP
UNIT PKG.-25

HOLE SIZE-8 MM
HD. DIAM.-18 MM; STEM-18 MM

3024



(10246149)
PLASTIC SCREW RIVET
ROCKER PANEL MOULDING
GM- "N" BODIES-'99 & UP
UNIT PKG.-25

HOLE SIZE-6 MM
FLANGE DIAM.-11 MM
PANEL RANGE-4.5- 7.5 MM
STEM LENGTH-18 MM

3112

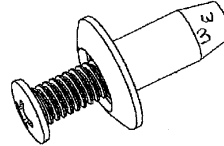

(W706494-S300)
PLASTIC SCREW RIVET
CLOSED END FENDER
WELL LINER RETAINER
FORD-TAURUS & SABLE-'99 & UP

HOLE SIZE-8 MM
HEAD DIAM.-18 MM; STEM-8 MM

3113

(N811283-S)

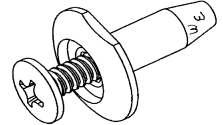

PLASTIC SCREW RIVET
CLOSED END INTERIOR
TRIM & MAT RETAINER
FORD-EXPEDITION &
NAVIGATOR-'97 & UP
UNIT PKG.-25

HOLE SIZE-6.3 MM
HEAD DIAM.-18 MM
STEM-18 MM; SHOULDER- 9.5 MM

3226



(BC1D-56-145)
PLASTIC PUSH RIVET
BUMPER COVER
FENDER LINER, MUD GUARDS
MAZDA-2004 & UP
UNIT PKG.-15

FOR 8 MM HOLE
HEAD DIAMETER-20 MM
STEM LENGTH-9 MM,

3241



(90467-09166)
PLASTIC SCREW RIVET
(PHILLIPS HEAD)
FENDER LINER CLIP
TOYOTA-2007 & UP
UNIT PKG.-15

HOLE SIZE-9 MM SQUARE HOLE
FLANGE DIAM.-20 MM
PIN LENGTH-20 MM

3272

(0G032-50037A)



PLASTIC SCREW RIVET
BUMPER COVER,
LOWER AIR DEFLECTOR
GRILLE, INTERIOR AND
EXTERIOR TRIM
KIA- 2000 & UP
UNIT PKG.-15

FOR 8.5 MM HOLE
FLANGE O.D.-18 MM
OVERALL BASE LENGTH-15 MM

3274

(6508197AA),(W706092-S300)

PLASTIC SCREW RIVET
GRILLE, FENDER LINER
REAR QUARTER PANEL
CHRYSLER, FORD-2007 & UP
UNIT PKG.- 25

FOR 6.4-6.9 MM HOLE
HEAD DIAMETER-18 MM
3-5 MM THICK PANEL

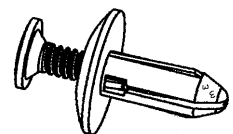

RETAINERS—PUSH/ SCREW TYPE, DOOR PANEL, BUMPER

3277

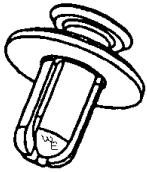

(86590-28000)
PLASTIC SCREW RIVET
FENDER LINER, BUMPER
COVER, GRILLE, & SPLASH
SHIELD RETAINER
 HYUNDAI- KIA- 2005 & UP
UNIT PKG.- 15

FOR 8 MM HOLE
FLANGE O.D.-18 MM
OVERALL LENGTH-18 MM

3287



(90467-05090-B1)
BLACK PLASTIC
SCREW RIVET
BUMPER COVER RETAINER
 TOYOTA—COROLLA, MATRIX,
 & SCION - 2008 & UP
UNIT PKG.- 10

FOR 5 MM HOLE
HEAD DIAMETER-18 MM
OVERALL BASE LENGTH-10 MM

3398

(90913-0051)



PUSH RIVET RETAINER
COWL GRILLE, FENDER LINER
& MOULDINGS
 (FOR 7 MM HOLE; 13 MM HD
 DIAM.; 20 MM FLANGE; 15 MM
 OVERALL LENGTH)
 SUBARU— FORESTER, LEGACY,
 OUTBACK, IMPREZA , XV CROSS-
 TREK & B9 TRIBECA
 2005-UP
UNIT PKG.-15

3347



(90467-05063-C0)
PLASTIC SCREW RIVET
HOOD SEAL RETAINER
 TOYOTA CELICA, CO-
 ROLLA & SCION TC
 2000 & UP
UNIT PKG.-15

FOR 5 MM HOLE
HEAD DIAM.- 11 MM
STEM LENGTH- 8 MM

999



WIRE ATTACHING CLIP-
GENERAL USE
UNIT PKG.-50

1210



(OE- 388033-S101)
DOOR PANEL FASTENER
REGULAR LONG THROAT
 FORD & UNIVERSAL
UNIT PKG.-50

1212



(OE- 1629341, 4114785)
DOOR PANEL FASTENER
CHRYSLER &
UNIVERSAL
UNIT PKG.-50

3356

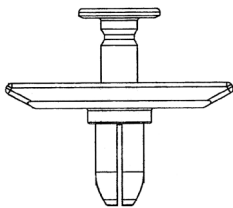

(55157112-AB,-AA)
PLASTIC PUSH RIVET
BMPR COVER RETAINER
 JEEP GRAND CHEROKEE
 2005 & UP

UNIT PKG.-15

FOR 9.5 MM HOLE
HEAD-25X45 MM
SHOULDER-3 MM

1213

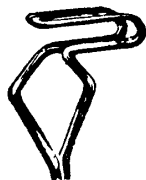

DOOR PANEL
FASTENER REGULAR
LONG THROAT
 FORD, CHRYSLER &
 RAMBLER
UNIT PKG.-50

1220



HOG RINGS- #5 SIZE
TO ATTACH SEAT
CUSHIONS AND SEAT
BOTTOMS
ALSO CLIP FOR
CUSHION SPRING
UNIT PKG.-500

3359



90914-0055
PLASTIC PUSH RIVET
W/SEALER-ROCKER
MOULDING RETAINER
 SUBARU-B9 TRIBECA,
 FORRESTER, LEGACY
 OUTBACK & IMPREZA
 2008 & UP
UNIT PKG.-5





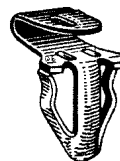

2200

(VW-N143893, 3100005)
(VOLVO-3104426)
DOOR PANEL FASTENER
 VW & OTHER FOREIGN CARS
UNIT PKG.-25

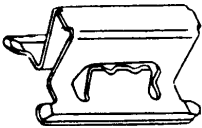

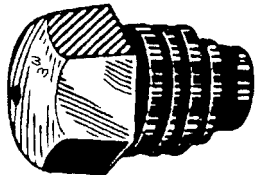
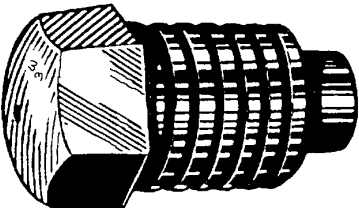
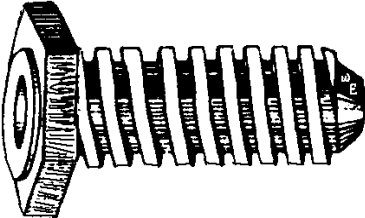
FOR 11 MM HOLE
FLANGE DIAM.-25 MM
O/A LENGTH-19 MM

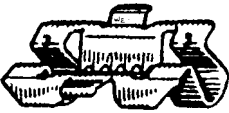
RETAINERS— DOOR PANEL, BUMPER, HOOD, TRUNK

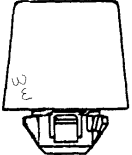
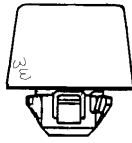
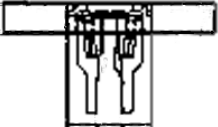
<p>2387</p>  <p>(OE-90183-03001) BUMPER CUSHION RETAINER TOYOTA- '82 & UP UNIT PKG.-10</p>	<p>2440</p>  <p>(OE-90468-04030) BUMPER STRIP RETAINER (STAINLESS STEEL) 15 MM WIDE X 27 MM LONG TOYOTA UNIT PKG.-25</p>	<p>2441</p>  <p>(388378), (1717924) RUBBER TRUNK LID/BUMPER FORD & GM- '79 & UP UNIT PKG.-5</p> <div style="border: 1px solid black; padding: 2px; text-align: center;"> <p>DIAMETER-11/16" OVERALL LENGTH-1-1/4"</p> </div>
<p>2442</p>  <p>(472450) RUBBER HOOD BUMPER-GM UNIT PKG.-5</p> <div style="border: 1px solid black; padding: 2px; text-align: center;"> <p>DIAMETER-15/16" OVERALL LENGTH- 1-29/32"</p> </div>	<p>2443 (34201347), (4103165)</p>  <p>NYLON HOOD BUMPER CHRYSLER- '81 & UP UNIT PKG.-5</p> <div style="border: 1px solid black; padding: 2px; text-align: center;"> <p>DIAMETER-18 MM OVERALL LENGTH- 47 MM</p> </div>	<p>2560</p>  <p>(6501352) DOOR PANEL FASTENER CHRYSLER UNIT PKG.-50</p>
<p>2607</p>  <p>(62228-61A00) BUMPER CUSHION RETAINER NISSAN UNIT PKG.-10</p>	<p>2767</p> <p>(53455-14020) HOOD PROP ROD CLIP TOYOTA UNIT PKG.- 15</p>  <div style="border: 1px solid black; padding: 2px; text-align: center;"> <p>HOLE SIZE-14 MM ROD DIAMETER-8 MM</p> </div>	<p>2676</p>  <p>(FORD-N803749-S32B) (REPLACES GM-22520702, 15594541) (REPLACES- CHRYSLER 6032268) RETAINER-DOOR & QUARTER PANEL TRIM, COWL VENT COVER, INSTRUMENT PANEL & CENTER CONSOLE TRIM UNIT PKG.-25</p>
<p>3206</p>  <p>(90084-54011) RUBBER HOOD BUMPER TOYOTA-CAMRY & AVALON 2004 & UP UNIT PKG.-10</p> <div style="border: 1px solid black; padding: 2px; text-align: center;"> <p>HOLE SIZE-9 MM OVERALL HEIGHT- 20 MM</p> </div>	<p>3209</p>  <p>(90084-54012) RUBBER DOOR & TRUNK LID BUMPER TOYOTA 2003 & UP UNIT PKG.-10</p> <div style="border: 1px solid black; padding: 2px; text-align: center;"> <p>HOLE SIZE-9 MM OVERALL HEIGHT- 17 MM</p> </div>	<p>3343</p>  <p>(11609697, REPL. 11588643) DOOR PANEL & COWL TRIM RETAINER WITH SEALER GM-CADILLAC SRX, CHEVY EQUINOX, GMC TERRAIN 2010 & UP UNIT PKG.-10</p> <div style="border: 1px solid black; padding: 2px; text-align: center;"> <p>FOR 6X20 MM HOLE HEAD 15X30 MM STEM LENGTH-17 MM</p> </div>

DOOR LOCK ROD END CLIPS/ RETAINERS

<u>PART #</u>	<u>SIDE</u>	<u>DESCRIPTION</u>
2505	RH	(3454220) CHRYSLER-'71 & UP
2506	LH	(3454221) CHRYSLER-'71 & UP
2507	RH	(N805350S) FORD-'69 & UP; (2945108) CHRYSLER-'69 & UP (16601263) GM-'69 & UP; (4003672) AMC-'69 & UP
2508	LH	(N804344S) FORD-'69 & UP; (2945109) CHRYSLER-'69 & UP (4003673) AMC-'69 & UP
2509	RH	(20582532)-GM (SUB FOR CHRYSLER-4717165)
2625	RH	(5257478, 4658676)-CHRYSLER (16630688)-GM



EACH NUMBER UNIT PKG.-25

1290
(2811852)

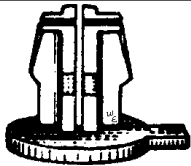

RETAINER FOR
GLASS GUIDE-PLASTIC
CHRYSLER & UNIVERSAL
UNIT PKG.-25

2538



(16606936), (166066936)
DOOR LOCK CLIP
BUICK, CADILLAC, OLDSMOBILE
PONTIAC & SATURN
UNIT PKG.-50

2273



(4234830), (9711304)
METAL DOOR LOCK CLIP
GM, GENERAL USE
UNIT PKG.-25

2951

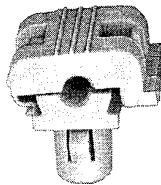
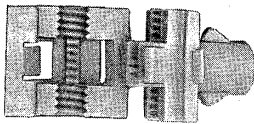

(16675980), (REPLACES-16629990)
ROD END CLIP
DOOR & TAIL GATE LOCKS
GM, FORD, FORD TRUCKS-'90 & UP
UNIT PKG.-10

2956

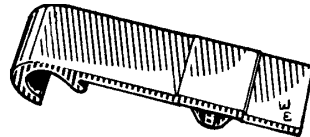

(91512-SEO-003)
WINDSHIELD WASHER
HOSE CLIP
HONDA ACCORD-'86 & UP
UNIT PKG.-15

3012

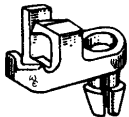

REPLACES-(3081052, 469716)
DOOR LOCK ROD END CLIP
GM, CHEV VANS-'77 & UP
UNIT PKG.-25

3080

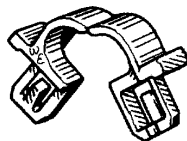

(90652-SB2-023)
RETAINER- WINDSHIELD
WASHER HOSE
FOR 7 MM SQUARE HOLE
5 MM OD HOSE
HONDA-'86 & UP
UNIT PKG.-15

3328

(91558-SE3-003)

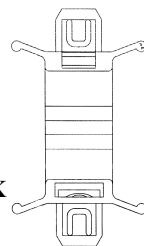
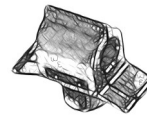

RELEASE CABLE RE-
TAINER-BLACK
PLASTIC; HOOD, FUEL DOOR, TRUNK
LID, & SLIDING SIDE DOOR
FOR 7 MM HOLE
FITS 5 MM CABLE DIAMETER
HONDA-ACURA, ACCORD,
CIVIC & CRV- 1991 & UP
UNIT PKG.-25

WINDSHIELD AND REAR WINDOW MOULDING CLIPS

3335
(69293-30030)



DOOR LOCK ROD END CLIP
(FOR 8 MM HOLE; 6 MM ROD)
TOYOTA-LEXUS-'93 & UP
UNIT PKG.-10

353

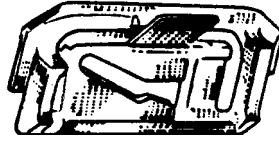

(OE-9731301, 4005540)
PLASTIC CLIP-WINDSHIELD,
REVEAL MOULDING
GM-'74 & UP; AMC '75 & UP
UNIT PKG.-50

354



(OE-1654048)
WINDSHIELD REVEAL
MOULDING CLIP
GM '75 & UP
UNIT PKG.-50

355

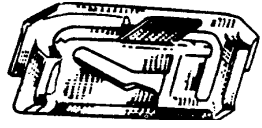

(OE-1654047)
PLASTIC WINDSHIELD REVEAL
MOULDING CLIP- GM
COMPACTS
(SMALLER SIZE THAN W&E #353)
UNIT PKG.-50

371



(OE-9808241)
REVEAL MOULDING CLIP
WINDSHIELD OR BACK
WINDOW-CHEVY CAMARO,
PONTIAC TEMPEST, BUICK
AND CADILLAC- '70-'71
UNIT PKG.-50

373

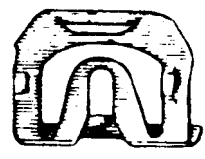

(OE-9854717, 8717859)
REVEAL MOULDING CLIP
WINDSHIELD (UPPER) &
REAR WINDOW
GENERAL MOTORS
UNIT PKG.-50

378



(OE-9662950, 20603072)
REVEAL MOULDING CLIP
WINDSHIELD (UPPER)-GM
UNIT PKG.-100

379

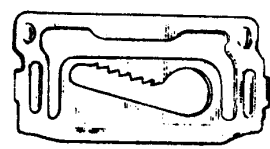

(OE-9895598)
WINDSHIELD REVEAL
MOULDING CLIP-GM
UNIT PKG.-50

384



(OE-4422660, 4474354)
(OE-8736588, 8736589)
(OE-8736590)
WINDSHIELD AND
REAR WINDOW-GM
UNIT PKG.-100

385



(OE-4506041, 4533669)
WINDSHIELD & REAR
WINDOW-GM
UNIT PKG.-50

386



(OE-7634583)
REAR WINDOW- GM
UNIT PKG.-50

387

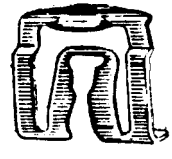

(OE-D1AB-6542413-AB)
(OE-C5ZZ-6542413-B)
WINDSHIELD & REAR
WINDOW
FORD MUSTANG & DATSUN
UNIT PKG.-100

WINDSHIELD MOULDING CLIPS/ GLASS GUIDES

389



(7693140, 8736586)
**REVEAL MOULDING CLIP
 WINDSHIELD AND
 BACK GLASS
 GM**
 UNIT PKG.-50

390

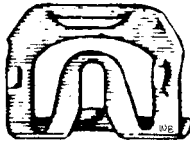

(OE-7698976)
**UPPER & LOWER REVEAL
 MOULDING CLIP
 WINDSHIELD & REAR
 WINDOW; USED WITH
 ALUM. MOULDINGS
 CHEVELLE, F-85
 TEMPEST, BUICK SPECIAL
 UNIT PKG.-50**

672



#8 X 3/8"
**PHILLIPS HEAD SHEET
 METAL SCREW
 (LOW PROFILE HEAD)
 USED FOR ATTACHING
 WINDSHIELD &
 WINDOW REVEAL
 MOULDING CLIPS**
 UNIT PKG.-100

2176

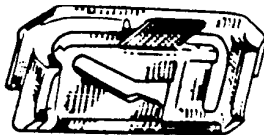

(OE-20169887)
**PLASTIC WINDSHIELD
 REVEAL MOULDING CLIP
 GM- '80 & UP
 (SIZED BETWEEN W&E #353
 AND W& E #355)
 UNIT PKG.-50**

2298



(OE-E3SB-6342413AB)
**BACK WINDSHIELD
 REVEAL MOULDING CLIP
 FORD T-BIRD '83 & UP**
 UNIT PKG.-50

2371

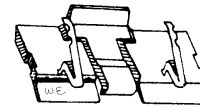

(PICTURE NOT ACTUAL SIZE)
 (OE-90674-SA6-0030)
**PLASTIC WINDSHIELD REVEAL
 MOULDING CLIP- SELF ADHESIVE
 HONDA-(LIGHT BLUE)**
 UNIT PKG.-10

2376

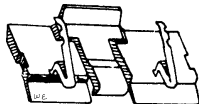

(PICTURE NOT ACTUAL SIZE)
 (OE-90674692-0030)
**PLASTIC WINDSHIELD REVEAL
 MOULDING CLIP- SELF
 ADHESIVE
 HONDA-BLACK**
 UNIT PKG.-10

2280

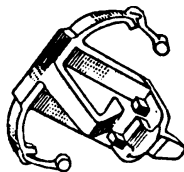

(OE-3066259)
 (PICTURE NOT EXACT SIZE)
**GARNISH MOULDING CLIP
 REAR GLASS- LOWER- GM**
 UNIT PKG.-15

2703

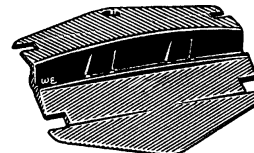

(PICTURE NOT ACTUAL SIZE)
 (10051034, 10114597,
 12338011, 20123070,
 20328600)
**WINDOW GUIDE
 FRONT DOOR -GM-'80& UP**
 UNIT PKG.-25

2908

(10142872)
**GLASS GUIDE
 FRONT DOOR WINDOW
 GM-"A" BODIES-'90 & UP**
 UNIT PKG.-10

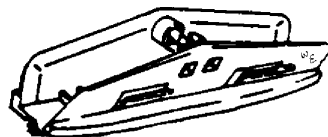

DOOR GLASS GUIDES, WINDOW REGULATOR, HANDLE PARTS

2955

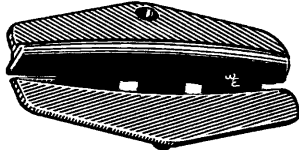

(PICTURE NOT ACTUAL SIZE)
(20747509, 20478732)
GLASS GUIDE
FRONT DOOR WINDOW
(REAR GUIDE)
GM-"C" & "H" BODY
'85&UP
UNIT PKG.-25

2975

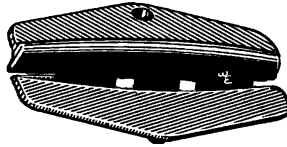

(PICTURE NOT ACTUAL SIZE)
(20162174, 22543363)
WINDOW GUIDE
FRONT DOOR
GM-"J" BODIES-'92 & UP
UNIT PKG.-25

2979

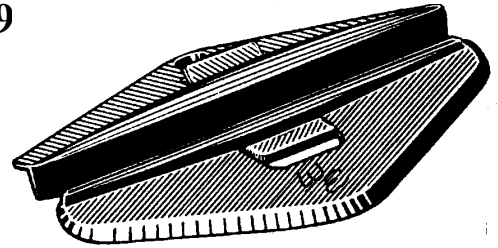

(PICTURE NOT ACTUAL SIZE)
(12353912, 20487630, 20712172, 20712176)
FRONT DOOR WINDOW GUIDE
(FRONT GUIDE)
GM-"C" BODIES-'85 & UP
"U" MINIVANS-'90 & UP
UNIT PKG.-15

3045

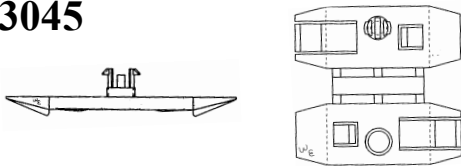

(10274778)
(PICTURES NOT ACTUAL SIZE)
PLASTIC FRONT SIDE DOOR WINDOW
GUIDE:GM MINIVANS, OLDS
SILHOUETTE, PONTIAC
MONTANA,TRANSPORT, CHEVY
VENTURE & LUMINA-1997 & UP
UNIT PKG.-10

3002

(20369894)
RIGHT SIDE

3003

(20369895)
LEFT SIDE

(PICTURES NOT ACTUAL SIZE)
WINDOW REGULATOR
GUIDE
ASSEMBLY-FRONT DOOR
"C" & "N" BODY STYLES
GM-'85 & UP

EACH UNIT PKG.-2

**WINDOW RISER KNOB
STUD & WASHER**

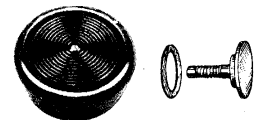

PART #	COLOR	MFG.
2249	CLEAR	GM
2250	BLACK	GM
2251	CLEAR	FORD

EACH UNIT PKG.-4

2579

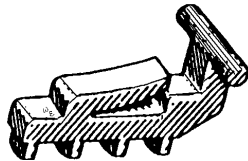

WINDOW REGULATOR
TAPE DRIVE BLOCK-GM-'80 & UP
UNIT PKG.-25

2938

*SAVE THE PRICE
OF A MOTOR, CHANGE PINS!*



(NOT SUPPLIED BY OE)
NYLON TORQUE PINS FOR
WINDOW REGULATOR
GEARS
PIN DIAMETER-.492"
PIN LENGTH-.432"
FORD & CHRYSLER-'64 & UP

UNIT PKG.-15

2954

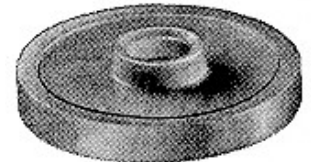

(D9AZ-54234A46-AA)
WINDOW GLASS RETAINER
FRONT/REAR DOORS;
TAIL GATE BRACKET
FORD/ LINCOLN-'79 & UP

UNIT PKG.-25

1262



INSIDE DOOR HANDLE
RETAINING CLIP-GM & FORD

UNIT PKG.-100

GLASS, WINDOW REGULATOR, SPECIALIZED RIVETS

2121

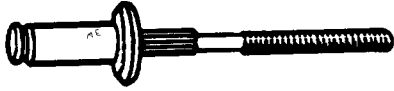

(9436175-GM), (385189-FORD),
(6031115-CHRYSLER)
SUPER SPLIT
ALUM. RIVET/ STEEL MANDREL
WINDOW REGULATOR RIVET 1/4"
DIAMETER
.032-.140" GRIP RANGE
.257-.261" HOLE REQUIRED
GM, FORD, CHRYSLER-'76 & UP
UNIT PKG.-25

2122

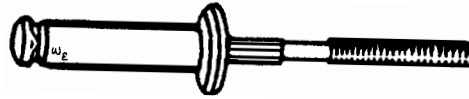

(385323-S100-FORD)
(6031091-CHRYSLER)
SUPER-SPLIT "GLASS STOP" RIVET
ALUM. RIVET/ STEEL MANDREL
1/4" DIAMETER
.520-.620" GRIP RANGE
.257-.261" HOLE REQUIRED
FORD, CHRYSLER-'76 & UP
UNIT PKG.-25

2123

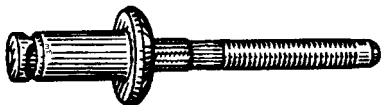

(388047-S100)
SUPER-SPLIT OUTSIDE DOOR
HANDLE RIVET- 1/4" DIAM.
ALUM. RIVET/
STEEL MANDREL
.090-.115" GRIP RANGE
257-.261" HOLE REQUIRED
FORD, LINCOLN/MERC.-'78 & UP
UNIT PKG.-25

2452

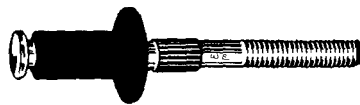

(OE-388047-S102)
DOOR HANDLE RIVET
PEEL TYPE-1/4" DIAMETER
.090-.115" GRIP RANGE
ZINC & BLACK PHOS.-FORD
UNIT PKG.-25

2563

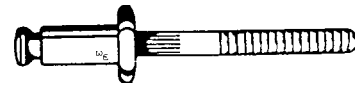

(9437552)
3/16" SUPER SPLIT RIVET
ALUM. RIVET/ STEEL
MANDREL
DOOR LATCH ASSEMBLY
.079-.109" GRIP RANGE-GM
UNIT PKG.-50

2622



(20184399, 389268-S100)
WINDOW REGULATOR RIVET
1/4" DIAMETER; 1/2" FLANGE
.638-.75" GRIP RANGE
(ALUM. RIVET/STEELMANDREL)
GM & FORD
UNIT PKG.-25

2728

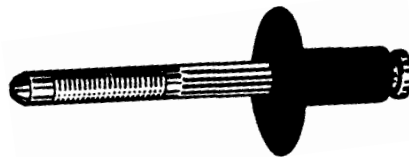







(N804193-S100)
DOOR HANDLE & LOCK
RIVET
1/4" DIAM., 3/4" HEAD, .03-.14"
GRIP RANGE
ALUM. RIVET/ STEEL
MANDREL
FORD-'84 & UP, BLACK
UNIT PKG.-25

2774

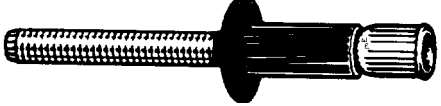

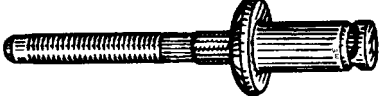
(15715058), (22643056)
WINDOW REGULATOR
RIVET
(1/4" STEEL RIVET/
MANDREL)
1/2" FLANGE DIAMETER
.057"-.157" GRIP RANGE
GM- '95 & UP
UNIT PKG.-25

GLASS, WINDOW REGULATOR, SPECIALIZED RIVETS

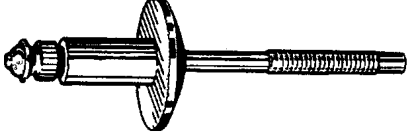
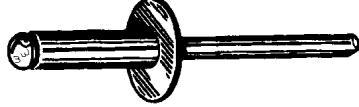
<p>2775</p>  <p>(22578214), (25630258) 1/4" DOOR HANDLE & WINDOW REGULATOR RIVET STEEL RIVET/STEEL MANDREL 1/2" FLANGE DIAMETER .08-.375" GRIP RANGE GM-'91 & UP BLACK UNIT PKG.-15</p>	<p>2776</p>  <p>(22579423), (22569178) 3/16" DOOR WINDOW/ SASH ATTACHMENT RIVET ALUM. RIVET/STEEL MANDREL 7/16" FLANGE DIAMETER .312"-.437" GRIP RANGE GM-'92 & UP UNIT PKG.-25</p>	<p>2890</p>  <p>(W525170-S417) 3/16" SPLIT ALUMINUM RIVET/STEEL MANDREL DOOR HANDLE/WINDOW REGULATOR 1/2" FLANGE DIAM. .031-.250" GRIP RANGE FORD-'95 & UP BLACK UNIT PKG.-25</p>
<p>2891</p>  <p>(REPL. W525172-S417) 1/4" ALUMINUM RIVET STEEL MANDREL-ZINC PLATED (DOOR HANDLE & MISC.) 1/2" FLANGE DIAM.; .031-.219" GRIP FORD-'95 & UP UNIT PKG.-15</p>	<p>3027</p>  <p>(22641917, 22585836) 3/16" DOOR HANDLE RIVET ALL STEEL 3/8" FLANGE O.D. .063-.266" GRIP RANGE GM-'J' & "K" BODIES-'94 & UP BLACK UNIT PKG.-25</p>	<p>2321</p>  <p>(GM-9432137) (CHRYSLER-6032138) 5/32" ALUMINUM RIVET/ STEEL MANDREL COUNTERSUNK HEAD TRUNK LOCK-SEALED END SWIVEL EMBLEM UNIT PKG.-25</p>
<p>2330</p>  <p>(372820-S36, S40) 1/4" RIVET -1/2" FLANGE FORD STEEL BUMPER RIVET ZINC/YELLOW UNIT PKG.-50</p>	<p>2353</p>  <p>(REPL. 388442-S100, 6032881) 1/4" RIVET- BUMPER ASSEMBLY ALL STEEL- 3/4" FLANGE O.D. .125-.250" GRIP RANGE FORD-'81 & UP, CHRYSLER ZINC PLATED UNIT PKG.-20</p>	<p>2354</p>  <p>(388664-S100) 3/16" RIVET GRILLE RETAINING ALL ALUMINUM 3/8-1/2" GRIP RANGE 9/16" LARGE FLANGE FORD-'79 & UP BLACK UNIT PKG.-25</p>

SPECIALIZED BLIND RIVETS

2480

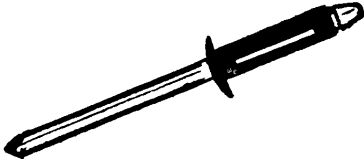

(N805592-S100)
(GM-25618730)
3/16" RIVET-ALL ALUMINUM
(SCUFF PLATE TO SILL)
(7/16" FLANGE)-.078-.236"
GRIP RANGE-BLACK
GM, FORD-LINCOLN-'89 & UP
UNIT PKG.-20

2630

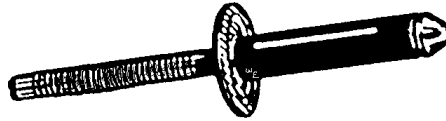

CHRYSLER-(6035201), FORD-(N806830-S100)
1/4" ALL ALUMINUM RIVET
BUMPER COVER AND
LICENSE PLATE BRACKET
11/16" FLANGE DIAM., .187-.375" GRIP RANGE
BLACK
UNIT PKG.-15

2688



REPLACES-(N805759-S100)
1/8" ALL ALUMINUM RIVET
FOR WINDSHIELD
SIDE RAIL
3/8" FLANGE DIAMETER
.063-.125" GRIP RANGE
FORD-'89 & UP
BLACK
UNIT PKG.-50



PART #

DESCRIPTION

2749 (N803933-S101) 1/8" CLOSED END
ALL ALUMINUM RIVET-BLACK
(15/64" HEAD DIAMETER)
(3/16-1/4" GRIP RANGE)
LUGGAGE RACK ATTACHMENT
FORD & UNIVERSAL
UNIT PKG.-50

2750 (390428-S100) 3/16" CLOSED END
ALL ALUMINUM RIVET-BLACK
(3/8" HEAD DIAMETER)
(3/8-1/2" GRIP RANGE)
LUGGAGE RACK ATTACHMENT
FORD & UNIVERSAL
UNIT PKG.-25

2852



(N804851-S100)
1/4" ALL ALUMINUM RIVET
9/16" FLANGE; UP TO .250" GRIP RANGE
TAURUS-SABLE '96 & UP
BLACK
UNIT PKG.-15

2858

(N808426-S100)

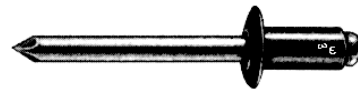

1/4" ALL ALUMINUM RIVET
(1/2" FLANGE DIAMETER)
(1/16-1/4" GRIP RANGE)
BUMPER FASCIA
FORD- BLACK
UNIT PKG.-25

2888



(15022087)
HEADLIGHT RETAINER
1/4" ALL STEEL
SHOULDER RIVET
(19/32" FLANGE DIAM., 25/64"
SHOULDER DIAM.)
(.047-.079" GRIP RANGE)
GM BLAZER- '98 & UP
ZINC
UNIT PKG.- 10

3332

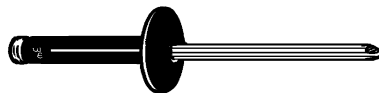

(11516807)
3/16"-BLACK- ALL ALUMINUM
SPLIT TYPE- RIVET
BMFR FASCIA/LICENSE PLATE
BRACKET-5/8" FLANGE
.047-.359" GRIP RANGE
GM '90 & UP-UNIVERSAL
UNIT PKG.-25

3422



(REPL.MERCEDES 003-990-94-97)
5/32"(4MM)-ALL ALUMIUM
SPLIT RIVET
5/16"(8MM) FLANGE;
.126-.187"(1-7MM) GRIP RANGE
MERCEDES & UNIVERSAL
UNIT PKG.-25

SPECIALIZED BLIND RIVETS

3190

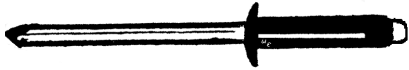

(GM-10131511)
(REPL. FORD-N807620-S100)
(CHRYSLER-6034212)
(REPL.NISSAN-01515-0009U)

5/32" ALL ALUMINUM SPECIAL
SPLIT RIVET-5/16" FLANGE, .04-
.275" GRIP RANGE
WHEEL OPENINGS, BUMPERS,
ROOF RACKS

BLACK
UNIT PKG.-25

3192

(10125439)



3/16" ALL ALUMINUM SPECIAL
SPLIT RIVET
BODY PANEL & MOULDINGS
3/8" FLANGE
.04-.354" GRIP RANGE
GM VANS-1990 & UP
BLACK
UNIT PKG.-25

3193



(10201332)

3/16" ALL ALUMINUM SPECIAL
SPLIT RIVET
3/8" FLANGE;.150-.472"GRIP RANGE
DOOR LOCK, MOULDINGS, DASH
INSULATION BLACK
GM -1990 & UP
UNIT PKG.-25

3217

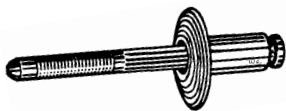

(N803138-S), (REPL-N804523S,
9442361, 25609048)
3/16" SPLIT RIVET
LARGE FLANGE
(ALUMINUM RIVET/ STEEL
MANDREL)
(9/16" FLANGE DIAMETER)
(.046-.203" GRIP RANGE)
FORD, GM
UNIT PKG.-25

3219

(N900-845-01)

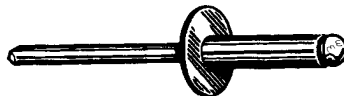

5/32" ALUMINUM RIVET/
STEEL MANDREL
LARGE FLANGE (15/32"DIAM.)
1/4"-3/8" GRIP RANGE
WHEELHOUSE MOULDING
RETAINER-BLACK
VW & UNIVERSAL
UNIT PKG.-25

3220



(11610383)

1/4" STEEL RIVET/
STEEL MANDREL
1/2" DOME HEAD, 1/64"-1/8" GRIP
RANGE
GM & UNIVERSAL
ZINC PLATED
UNIT PKG.-25

3289



(20325696)
1/8" RIVET

ALUMINUM RIVET/
STEEL MANDREL
.325" FLANGE DIAMETER
.125-.187" GRIP RANGE
REAR WINDOW GASKET
RETAINER-GM
UNIT PKG.-50

3298

(979878-6)



ALL ALUMINUM RIVET- SPECIAL
SPLIT TYPE- BLACK PLASTIC HD
BUMPER COVER &
WHEELHOUSE MOULDING
5 MM RIVET, 12 MM FLANGE
VOLVO
UNIT PKG.-15

3288



(9439719)
3/16" LARGE FLANGE RIVET
STEEL RIVET/STEEL MANDREL
5/8" FLANGE DIAMETER
.250-.375" GRIP RANGE
BUMPER FASCIA RETAINER
GM
BLACK
UNIT PKG.-50

3424



(REPL. FORD 378527)
1/8" DIAMETER ALL ALUMINUM BLIND RIVET
1/4" HEAD DIAM.; 1/8-3/16" GRIP RANGE
FORD & UNIVERSAL
UNIT PKG.-50

**PLASTIC CAPPED BLIND RIVETS ALUMINUM RIVET/ STEEL MANDREL
TOYOTA/ LEXUS 1998 AND UP**

3247

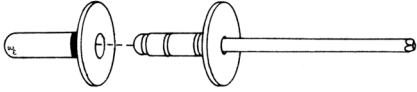

**(90269-04006)
DOOR DRIP MOULDING RETAINER**

UNIT PKG.- 15

DIAMETER-3.2 MM (1/8")
HOLE SIZE-4 MM (5/32")
FLANGE-8 MM (5/16")
GRIP RANGE-1.2- 4 MM (3/64-5/32")

3248

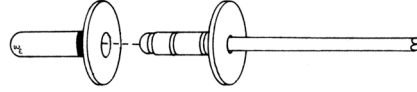

**(90269-04050)
WINDSHIELD/ TRUNK MOULDING RETAINER
GS & SC MODELS**

UNIT PKG.- 15

DIAMETER-3.2 MM (1/8")
HOLE SIZE-4.3 MM (11/64")
FLANGE-8 MM (5/16")
GRIP RANGE-1.4- 3.2 MM (1/16-1/8")

3249

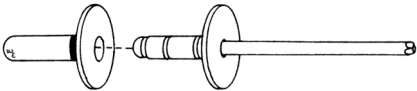

**(90269-04051)
(REPLACES-90269-A0006)
DOOR WINDOW MOULDING RETAINER
CAMRY / ES & IS
UNIT PKG.- 15**

DIAMETER-3.2 MM (1/8")
HOLE SIZE-4.4 MM (11/64")
FLANGE-6 MM (15/64")
GRIP RANGE-TO 3.4 MM (9/64")

3250

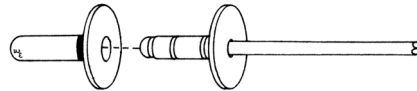

**(90269-04053)
MOULDING RETAINER
LAND CRUISER / LX-470
BLACK RIVET
UNIT PKG.- 10**

DIAMETER-3.2 MM (1/8")
HOLE SIZE-4.3 MM (11/64")
FLANGE-8 MM (5/16")
GRIP RANGE-1- 3.2 MM (1/32-1/8")

3251

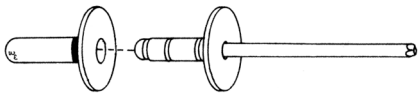

**(90269-05054)
GAS FILLER DOOR/WINDSHIELD
SIDE MOULDING CAMRY & SIENNA
UNIT PKG.- 10**

DIAMETER-4 MM (5/32")
HOLE SIZE-5.2 MM (13/64")
FLANGE-14 MM (9/16")
GRIP RANGE-1-4 MM (1/32-11/64")

3252

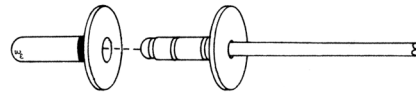

**(90269-05065)
BUMPERS / GENERAL USE ALL MODELS 2004 & UP**

UNIT PKG.- 10

DIAMETER-4 MM (5/32")
HOLE SIZE-5.2 MM (13/64")
FLANGE-12 MM (15/32")
GRIP RANGE-4- 6.5 MM (5/32-7/64")

3253

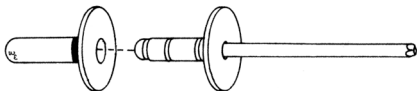

**(90269-06013)
GAS FILLER DOOR, CAMRY/ IS-300
UNIT PKG-15**

DIAMETER-4.8 MM (3/16")
HOLE SIZE-6.2 MM (1/4")
FLANGE-14 MM (35/64")
GRIP RANGE-1- 3 MM (1/32-1/8")

STANDARD BLIND RIVETS



<u>PART #</u>	<u>UNIT PKG.</u>	<u>HEAD</u>	<u>MATERIAL</u>	<u>RIVET</u>	<u>PANEL DIAM.</u>	<u>THICKNESS</u>
1250 (ABA 4-3N)	250	*Narrow Flange	Aluminum Rivet/Aluminum Mandrel		1/8"	Up to 3/16"
2130 (SBS 4-2)	250	Dome	Steel Rivet/Steel Mandrel		1/8"	Up to 1/8"
2131 (SBS 4-4)	250	Dome	Steel Rivet/Steel Mandrel		1/8"	1/8 to 1/4"
2132 (SBS 4-6)	100	Dome	Steel Rivet/Steel Mandrel		1/8"	1/4 to 3/8"
2133 (SBS 5-6)	100	Dome	Steel Rivet/Steel Mandrel		5/32"	1/4 to 3/8"
2134 (SCS 4-2)	100	Countersunk	Steel Rivet/Steel Mandrel		1/8"	Up to 1/8"
2135 (SCS 4-4)	100	Countersunk	Steel Rivet/Steel Mandrel		1/8"	1/8 to 1/4"
2136 (FBS 4-3)	100	*Narrow Flange	Stainless Steel Rivet/Steel Mandrel		1/8"	Up to 3/16"
2137 (ABA 6-2)	100	Dome	Aluminum Rivet/Aluminum Mandrel		3/16"	Up to 1/8"
2138 (ABA 6-4)	100	Dome	Aluminum Rivet/Aluminum Mandrel		3/16"	1/8 to 1/4"
2139 (ABA 6-6)	100	Dome	Aluminum Rivet/Aluminum Mandrel		3/16"	1/4 to 3/8"
2162 (ABA 66L)	100	Large Flange	Aluminum Rivet/Aluminum Mandrel		3/16"	1/4 to 3/8"
2928 (ABA68L)	50	Large Flange	Aluminum Rivet/Aluminum Mandrel		3/16"	3/8 to 1/2"
2263 (ABA 610L)	50	Large Flange	Aluminum Rivet/Aluminum Mandrel		3/16"	1/2 to 5/8"
2470 (ABA 44L)	250	Large Flange	Aluminum Rivet/Aluminum Mandrel		1/8"	1/8 to 1/4"
2537(OE9432552)	100	Large Flange	Aluminum Rivet/Steel Mandrel		1/8"	1/8 to 3/16"
2471 (ABA 4-6)	250	Dome	Aluminum Rivet/Aluminum Mandrel		1/8"	5/16 to 3/8"
2472 (ABA 4-8)	100	Dome	Aluminum Rivet/Aluminum Mandrel		1/8"	3/8 to 1/2"
2536 (ABA 4-4)	250	Dome	Aluminum Rivet/Aluminum Mandrel		1/8"	3/16 to 1/4"
2792 (SCS43)	100	Countersunk	Stainless Steel Rivet/Steel Mandrel		1/8"	Up to 3/16"
2856 (ABA 64L)	50	Large Flange	Aluminum Rivet/Aluminum Mandrel		3/16"	1/8 to 1/4"
2929 (SBS68L)	50	Large Flange	Steel Rivet/Steel Mandrel (OE-547609)		3/16"	3/8 to 1/2"
2857 (SBS 8-8)	25	Dome	Steel Rivet/Steel Mandrel		1/4"	3/8 to 1/2"

*Use to Replace Welded Studs on Body- For plastic Clips(Flange O.D. 0.208")

BLACK RIVETS- ALUMINUM RIVET/ ALUMINUM MANDREL



<u>PART #</u>	<u>DESCRIPTION</u>	<u>UPKG</u>
2688 (ABA42L)BA	1/8" DOME HEAD (3/8" FLANGE DIAM.) (1/16 - 1/8" PANEL THICKNESS)	50
2590 (ABA46) BA	1/8" DOME HEAD (5/16 - 3/8" PANEL THICKNESS)	100
2588 (ABA66L) BA	3/16" DOME HEAD (LARGE FLANGE-5/8" DIAM.) (1/4- 3/8" PANEL THICKNESS)	50
2589 (ABA66) BA	3/16" DOME HEAD (1/4 - 3/8" PANEL THICKNESS)	50

STEEL RIVET BACKUP WASHERS- PLATED

<u>Part #</u>	<u>Size</u>	<u>Upkg.</u>	<u>Part #</u>	<u>Size</u>	<u>Upkg.</u>
985	1/8"	500	2194	3/16"	500
986	1/8"	1000	2521	13/64"(.734"-O.D.;.047"THICK)	250

NYLON BLIND RIVETS

(FOR PLASTIC RIVET TOOL SEE PRG-30 (PG. 140) (FOR PLASTIC RIVET ASSORTMENTS SEE NRA-60-(PG.156)

2264

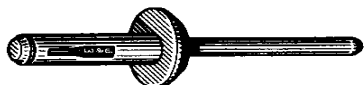

(FORD-8048635), (GM-20432975)
(CHRYSLER-6500899,6500859)
(VW-175-853-577), (AMC-34202855)
NYLON BLIND RIVET
HOLE DIAM: 5 MM (3/16")
PANEL RANGE- 3 MM- 6 MM
(1/8-1/4")
HEAD DIAM.- 12 MM (1/2")
UNIT PKG.-25

2266

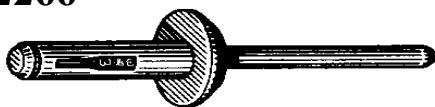

(KA01500Z1)
(GM-15506827, 15506921)
(14063981; REPL. GM-15614746)
(CHRY.-6500911; REP-34201631)
(AMC-8934-201-631)
NYLON BLIND RIVET
HOLE DIAM: 6.3 MM (1/4")
PANEL RANGE- 4 MM- 10 MM (5/32-8")
HEAD DIAM.- 17 MM (11/16")
UNIT PKG.-25

2267

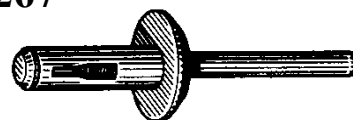

(GM-20433026, 14070914)
(CHRYSLER-4370132)
(VW-175-853-577A)
NYLON BLIND RIVET
HOLE DIAM: 7.0MM (17/64")
PANEL RANGE- 2.5 MM- 5 MM
(3/32-3/16")
HEAD DIAM.- 18 MM (45/64")
UNIT PKG.-25

2265

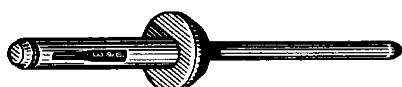

(CHRYSLER-6500898)
NYLON BLIND RIVET
HOLE DIAM: 5 MM (3/16")
PANEL RANGE- 6 MM- 10 MM
(1/4-3/8")
HEAD DIAM.- 12 MM (1/2")
UNIT PKG.-25

2641

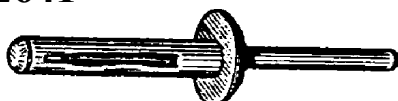

(GM-25524005)
NYLON BLIND RIVET
HOLE DIAM: 6 MM (1/4")
PANEL RANGE- 4 MM- 8.5 MM
(5/32-21/64")
HEAD DIAM.- 13 MM (1/2")
UNIT PKG.-25

2640



(GM-20465395, 20612732)
(CHRY-6004212),
FORD-W712991S300)
NYLON BLIND RIVET
HOLE DIAM: 5 MM (3/16")
PANEL RANGE- 3 MM- 4 MM
(1/8-5/32")
HEAD DIAM.- 9 MM (23/64")
UNIT PKG.-25

2642

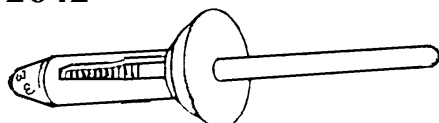

(15732202), (4630088)
(REPLACES-4630660)
COUNTERSUNK NYLON BLIND RIVET
HOLE DIAM: 6.3 MM (1/4")
PANEL RANGE-.07 MM-4.5 MM
(1/32-11/64")
2 MM SHOULDER
HEAD DIAM.- 17 MM (11/16")
UNIT PKG.-25

2485

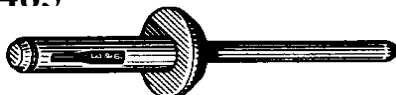

(GM-20452072, 10184895)
(FORD-N803862S, W70432-S300)
(CHRY-6501559,6506007AA)
NYLON BLIND RIVET
HOLE DIAM: 6.3 MM (1/4")
PANEL RANGE- 4 MM- 10 MM
(5/32-3/8")
HEAD DIAM.- 13 MM (1/2")
UNIT PKG.-25

2653

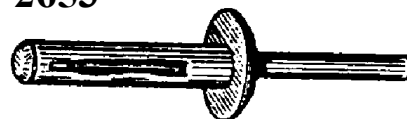

(CHRYSLER-6503860,
4370138)(FORD-N804675S)
NYLON BLIND RIVET
HOLE DIAM: 6.3 MM (1/4")
PANEL RANGE- 8 MM- 12 MM
(5/16-1/2")
HEAD DIAM.- 16.8 MM (21/32")
UNIT PKG.-25

2270



(PICTURE SMALLER THAN ACTUAL SIZE)
(GM-20421672, 15955172)
NYLON BLIND RIVET
HOLE DIAM: 6.3MM (1/4")
PANEL RANGE- 2.5 MM- 5 MM
(3/32-3/16")
HEAD DIAM.- 13.08 MM (1/2")
UNIT PKG.-25

2439

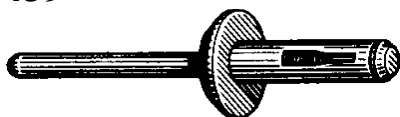







GM-10109689)
NYLON BLIND RIVET
HOLE DIAM: 7 MM (9/32")
PANEL RANGE- 2.5 MM- 6 MM
(3/32-15/64")
HEAD DIAM.- 18 MM (45/64")
UNIT PKG.-25

2355

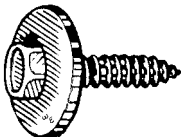
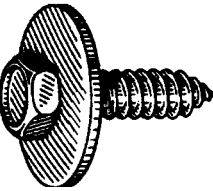
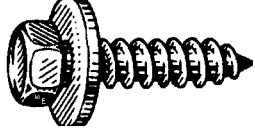
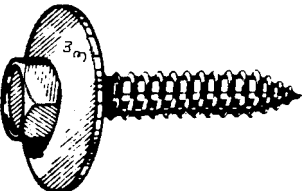
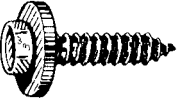
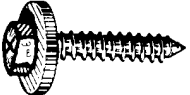

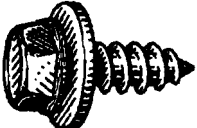
(PICTURE SMALLER THAN ACTUAL SIZE)
(N804583-S)
NYLON BLIND RIVET
HOLE DIAM.-3.96MM(5/32")
PANEL RANGE- 6 MM-10.5 MM
RECTANGULAR HD-8X15MM
COWL VENT GRILLE
FORD AEROSTAR-'86 & UP
UNIT PKG.-25

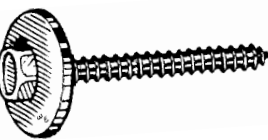
HEX HEAD SCREWS-LOOSE WASHER

<p>2193</p>  <p>(11503892), (11503403) (sub for 11514314) 4.2-1.41 X 20 MM UNSLOTTED-INDENTED HEX HD SCREW WITH LOOSE WASHER (16 MM WASHER; 7 MM HEX) PANEL TO FRAME, ALSO GRILLE GM AND UNIVERSAL BLACK PHOSPHATE UNIT PKG.-50</p>	<p>2256</p>  <p>(11507083) 6.3 MM X 25 MM HEX HD SCREW (24 MM LOOSE WASHER) GM & UNIVERSAL BLACK UNIT PKG.-25</p>	<p>HEX HEAD SHEET METAL SCREW (11/16" LOOSE WASHER; 3/8" HEAD)-AB</p>  <p>2328-1/4 X 3/4" 2329-1/4 X 1" ZINC PLATED EACH UNIT PKG.-50</p>
<p>2287</p>  <p>(REPLACES- 11503436) 6.3 X 35 MM (1/4 X 1-3/8") HEX HEAD SCREW WITH 24 MM (15/16") LOOSE WASHER BLACK GM & UNIVERSAL UNIT PKG.-25</p>	<p>2322</p>  <p>(11504056), (11503396) (11503483) 4.2-1.41 X 20 MM (#8 X 3/4") UNSLOTTED HEX HD SCREW (7 MM HEX; WITH 12 MM LOOSE WASHER) GM- "J" & "X" BODIES BLACK UNIT PKG.-100</p>	<p>2514</p>  <p>(6033801) #8 X 1" INDENTED HEX HEAD PHILLIPS TAPPING SCREW WITH 7/16" LOOSE WASHER CHRYSLER & UNIVERSAL BLACK PHOSPHATE UNIT PKG.-50</p>
<p>2342</p>  <p>#8 X 3/4" HEX HEAD SCREW WITH 1/2" LOOSE WASHER "HI-LOW" THREAD (USE FOR PLASTIC OR FIBERGLASS) UNIT PKG.-50</p>	<p>2423</p>  <p>(11505022) 6.3 X 20 MM HEX WASHER HEAD SCREW WITH 17 MM LOOSE WASHER (10 MM HEX) GM & UNIVERSAL-BLACK UNIT PKG.-25</p>	<p>2489</p>  <p>(11503397, 11514377) (REPLACES 11514845) 4.2 X 25 MM HEX HEAD SCREW WITH 12.5 MM LOOSE WASHER (7 MM HEX) GM AND UNIVERSAL-BLACK UNIT PKG.-50</p>
<p>3317 (11518755)</p>  <p>4.2-1.4 X 35 MM INDENTED HEX HEAD SCREW-AB (7 MM HEX) WITH 17 MM LOOSE WASHER-BLACK UNIT PKG.-50</p>	<p>3373</p>  <p>6.3-1.81 X 20 MM PHILLIPS HEX SCREW WITH 13 MM FREE SPINNING WASHER-(10 MM HEX) BLACK ZINC UNIT PKG.-50</p>	

HEX HEAD SCREWS-LOOSE WASHER

2634

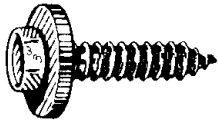

(11505023), (11500996)
**6.3 X 25 MM HEX HEAD SCREW
 WITH 17 MM LOOSE WASHER
 (10 MM HEX)
 BLACK
 GM & UNIVERSAL
 UNIT PKG.-50**

2684



(11513895)
**6.3 X 35 MM HEX HEAD SCREW
 WITH 12 MM LOOSE WASHER
 (10 MM HEX)
 GM & UNIVERSAL
 BLACK PHOSPHATE
 UNIT PKG.-25**

2730



**#10 X 1"
 HEX HEAD SCREW-AB
 WITH 5/8" LOOSE WASHER
 BLACK
 UNIT PKG.-50**

2746



(11505204)
**4.2 X 20 MM TORX PAN HEAD
 SEMS SCREW
 STAINLESS STEEL
 (8 MM LOOSE FLAT WASHER)
 BLACK
 UNIT PKG.-50**

2782

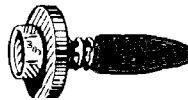

(25640776)
**4.2-1.41 X 20 MM
 UNSLOTTED-INDENTED
 HEX HEAD SCREW
 LOOSE WASHER
 (15 MM WASHER; 7 MM HEX)
 GM-BLACK WITH SEALER
 UNIT PKG.-50**

2800

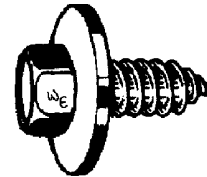

(GM 11501003)
**8 MM X 20 MM HEX HD
 SHEET METAL SCREW WITH
 24 MM LOOSE WASHER
 (13 MM HEX)
 BLACK
 UNIT PKG.-25**

2853



**5 MM X 16 MM PHILLIPS
 TRUSS HEAD SCREW
 16 MM LOOSE WASHER
 JAPANESE CARS/ UNIVERSAL
 BLACK/ ZINC
 UNIT PKG.-50**

2920

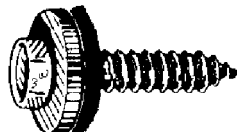

(10016640)
**6.3 X 25 MM HEX HEAD
 SEMS-AB
 WITH SEALER 10 MM HEX
 16.5 MM WASHER-BLACK
 UNIT PKG.-50**

2940



**4.2 X 30 MM (#8 X 1-3/16")
 PHILLIPS (POZI) PAN HEAD SHEET METAL
 SCREW WITH 8 MM LOOSE WASHER
 MARKER LENS, TAIL LENS
 GM & UNIVERSAL-FOR EXTERNAL USE
 BLACK
 UNIT PKG.-50**

3316



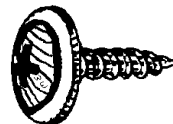

**4.2-1.4 X 13 MM
 PHILLIPS PAN HEAD-SCREW-AB
 WITH 12 MM ATTACHED
 FREE SPINNING WASHER
 (#8 X 1/2"; 1/2" WASHER)-BLACK
 UNIT PKG.-100**

3416

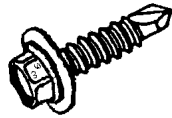
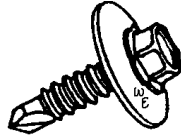
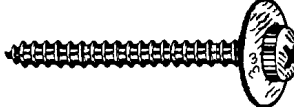
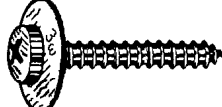

**M5-2.12 X 20 MM
 PHILLIPS TRUSS HEAD SCREW WITH 16 MM LOOSE WASHER
 BLACK/ZINC
 JAPANESE CARS & UNIVERSAL
 UNIT PKG.-25**

HEX HEAD SCREWS-LOOSE WASHER-BLACK

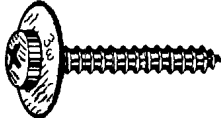
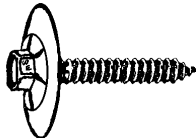
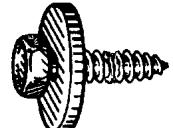
<p>2981</p>  <p>(GM 11514415) 4.2-1.41 X 35 MM UNSLOTTED INDENTED HEX HEAD SCREW WITH 7 MM HEX; 12 MM LOOSE WSHR BLACK UNIT PKG.-50</p>	<p>3015</p>  <p>4.2-1.41 X 20 MM INDENTED HEX WASHER HEAD SELF DRILLING SCREW WITH ATTACHED 12 MM LOOSE WASHER 7 MM HEX BLACK UNIT PKG.-50</p>	<p>3016</p>  <p>4.2-1.41 X 20 MM INDENTED HEX WASHER HEAD SELF DRILLING SCREW WITH ATTACHED 16 MM LOOSE WASHER; 7 MM HEX BLACK UNIT PKG.-50</p>
<p>3050</p>  <p>(FORD-W707484-S900) 4.2-1.41 X 35 MM (#8 X 1-3/8") PHILLIPS POZIDRIVE SCREW AB WITH 16 MM FREE SPINNING WASHER ZINC/BLACK UNIT PKG.-50</p>	<p>3051</p>  <p>(GM-15967438) 4.8-1.59 X 35 MM (#10 X 1-3/8") PHILLIPS POZIDRIVE SCREW AB WITH 12 MM FREE SPINNING WASHER ZINC/BLACK UNIT PKG.-50</p>	<p>3101</p>  <p>(N806088-S58) (4.2-1.41 X 25 MM) (#8 X 1") PHILLIPS PAN HEAD SHEET METAL SCREW-AB WITH ATTACHED FREE SPINNING WASHER (11 MM WASHER O.D) FORD BLACK UNIT PKG.-50</p>
<p>3110</p>  <p>(N808592-S100) 4.2-1.41 X 25 MM (#8 X 1") PHILLIPS PAN HEAD SCREW-AB WITH 16 MM ATTACHED FREE SPINNING WASHER FORD BLACK UNIT PKG.-50</p>	<p>3111</p>  <p>(W710441-S) 4.2-1.41 X 25 MM UNSLOTTED-INDENTED HEX WASHER HEAD SCREW WITH LOOSE WASHER (22 MM WASHER; 7 MM HEX) FORD & UNIVERSAL BLACK UNIT PKG.-50</p>	<p>3117</p>  <p>4.8-1.59 X 16 MM (#10 X 5/8") HEX HEAD SHEET METAL SCREW-AB WITH 19 MM LOOSE WASHER 8 MM HEX FORD & UNIVERSAL ZINC/BLACK UNIT PKG.-50</p>

SHEET METAL SCREWS-BLACK

3118

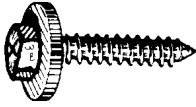

(11588286)
4.2-1.4 X 20 MM (#8 X 3/4")
PHILLIPS INDENTED HEX HEAD
SHEET METAL SCREW-AB
17 MM LOOSE WASHER; 7 MM HEX
GM
BLACK
UNIT PKG.-50

3238

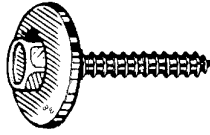

(25655545), (REPL.-11515354)
4.2-1.4 X 25 MM
HEX HEAD SCREW-AB
(17 MM LOOSE WASHER)
(7 MM HEX)- BLACK
UNIT PKG.- 50

3257

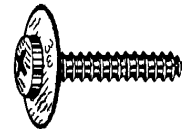

(FORD W710921-S; repl.N801603-S2)
4.2-1.41 X 20 MM
(#8 X 3/4"; 5/8" WASHER)
PHILLIPS-POZI DR- PAN HD
SCREW-AB;W/ 16 MM WASHER
BLACK
UNIT PKG.- 50

PHILLIPS FLAT HEAD SCREWS-BLACK



<u>PART#</u>	<u>SIZE</u>
2557	#8 X 1/2"
2558	#8 X 3/4"
2584 (# 6 HEAD)	#8 X 3/4"

EACH NUMBER UNIT PKG.-100

2225



(OE-11501903)
PHILLIPS FLAT WASHER HD. SCREW
POZIDRIVE
4.2 MM X 10 MM (11 MM, 7/16" WASHER)
GM & UNIVERSAL
BLACK
UNIT PKG.-100

2859

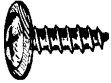

(REPLACES-
GM-11505104, 11514970)
4.2 X 13 MM (#8 X 1/2")-AB
(11 MM WASHER DIAMETER)
PHILLIPS FLAT WASHER HEAD
SHEET METAL SCREW
POZIDRIVE
NICKEL/ BLACK
UNIT PKG.-50

2226

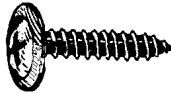

(OE-11501884)
PHILLIPS FLAT WASHER
HEAD SCREW
4.2 MM X 20 MM-POZIDRIVE
(7/16" WASHER)
GM & UNIVERSAL
BLACK
UNIT PKG.-100

2881



(GM-11514281)
4.2-1.41 X 25 MM
(11 MM WASHER O.D.)
PHILLIPS FLAT WASHER HEAD
SHEET METAL SCREW
BLACK
UNIT PKG.-100

2777

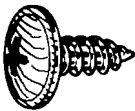

4.8-1.59 X 15 MM (#10 X 5/8")
PHILLIPS WASHER HEAD
(14 MM WASHER O.D.)
SHEET METAL SCREW-AB
NISSAN BUMPER &
UNIVERSAL-BLACK
UNIT PKG.-50

2778

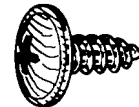

6.3-1.81 X 16 MM (#14 X 5/8")
PHILLIPS WASHER HEAD
(15.5 MM WASHER DIAM.)
SHEET METAL SCREW-AB
JAPANESE CARS & UNIVERSAL- BLACK
UNIT PKG.-50

SHEET METAL SCREWS-BLACK

ROUND (FLAT TOP) WASHER HEAD SHEET METAL SCREWS- AB-BLACK



<u>PART #</u>	<u>OE #</u>	<u>DESCRIPTION</u>	<u>UPKG.</u>
2325	(FORD-56901-S2) (GM-11503569)	4.2 X 10 MM (#8 X 3/8") (25/64" WASHER O.D.) POZI DRIVE	100
2585	(FORD-56902-S2)	#8 X 1/2" (3/8" WASHER O.D.)	100
2227	(FORD-56902) (GM-11501896)	4.2 X 13 MM(#8 X 1/2") (21/64" WASHER O.D.) POZI DRIVE	100
2665	(GM-11503421) (CHRYSLER-9422202)	4.2 X 13 MM (#8 X 1/2") POZIDRIVE (10 MM/25/64" WASHER O.D.)	100
3256	(FORD-59303-S2)	#8-18-5/8" (3/8" WASHER O.D.)	100
2787	(FORD-56912-S2)	#8-18 X 3/4" (1/2" WASHER O.D.)	100
2345	(CHRYSLER 9428738, 6032723) (FORD-56904-S2)(GM-11504766)	#8-15 X 3/4" (13/32" WASHER O.D.)	100
3255		#8-18 X 3/4" (3/8" WASHER O.D.)	100
2840	(FORD-56913-S2)	#8-18 X 7/8" (1/2" WASHER O.D.)	100
2575	(GM-11509237)	#8 X 1"(4.2 X 25MM) (11/32" WASHER O.D.) POZI DRIVE	100
2623		#8 X 1" (27/64" WASHER O.D.)	100
2841	(FORD-56914-S2)	#8-18 X 1" (1/2" WASHER O.D.)	100
2586	(FORD-56916-S2)	#8 X1-1/2" (1/2" WASHER O.D.)	50
2921		#10-16 X 3/4" (1/2" WASHER O.D.)	50
2922		#10-16 X 1" (1/2" WASHER O.D.)	50

SHEET METAL SCREWS-BLACK

PHILLIPS OVAL HEAD- A



<u>PART</u>	<u>SIZE</u>	<u>UPKG.</u>
673	#8 X 1/2" (#6 HD)	100
2331	#8 X 1/2"	100
674	#8 X 3/4" (#6 HD)	100
2332	#8 X 3/4"	100
675	#8 X 1" (#6 HD)	100
2333	#8 X 1"	100
676	#8 X 1-1/4" (#6 HD)	100
2334	#8 X 1-1/4"	100
2762	#8 X 1-1/2"	100
(11503555)	(4.2-1.41X 40MM)	
2715	#8 X 2-1/2" (#6 HD)	50
2335	#10 X 3/4"	100
2149	#10 X 1"	100
2743	#10 X 1" (#8 HD)	100

PHILLIPS PAN HEAD- AB



<u>PART #</u>	<u>SIZE</u>
2742	#6 X 1"
2838	#8 X 3/8" (OE-55926-S424)
2148	#8 X 1/2"
2319	#8 X 3/4"(type A)
2320	#8 X 1"
2839	#8 X 1-1/4" (OE-55930-S2)
2804	#10 X 1/2" (OE-154804)
2805	#10 X 5/8" (OE-6032899,W504262)
2424	#10 X 3/4"
2401	#10 X 1"
2905	#14 X 1" (6.3 X 25 MM) (OE-11514331)

EACH UNIT PKG.-100

PHILLIPS OVAL HEAD FINISHING SCREWS-SEMS-AB-BLACK (All #6 Head)



<u>PART #</u>	<u>SIZE</u>	<u>WASHER TYPE</u>	<u>UPKG.</u>
2343	#8 X 1/2"	FLUSH	50
2296	#8 X 3/4"	COUNTERSUNK	100
2297	#8 X 1"	COUNTERSUNK	100
2528	#10 X 3/4"	COUNTERSUNK	50
2529	#10 X 1"	COUNTERSUNK	50

2685



#8 X 1/2" SELF DRILLING
SHEET METAL SCREW
PHILLIPS ROUND
WASHER HEAD
(3/8" WASHER O.D.)
BLACK OXIDE

UNIT PKG.-100

2340



#8 X 1/2" PHILLIPS FLAT WASHER HEAD SCREW-SELF DRILLING
(4.2MM X 13MM), (7/16" WASHER O.D.)
GM, FORD, CHRYSLER, FOREIGN & UNIVERSAL
ZINC/BLACK
UNIT PKG.-100

SHEET METAL SCREWS-BRIGHT

PHILLIPS OVAL HEAD NICKEL PLATED-A



<u>PART NO.</u>	<u>SIZE</u>	<u>UNIT PACKAGE</u>
629	#4 X 3/4"	100
628	#6 X 1"	100
631	#8 X 1/2"	100
2411	#8 X 1/2" (#6 HD)	100
633	#8 X 5/8" (#6 HD)	100
635	#8 X 3/4"	100
636	#8 X 1" (#6 HD)	100
637	#8 X 1"	100
638	#8 X 1-1/4"	100
639	#8 X 1-1/4" (#6 HD)	100
641	#8 X 1-3/4" (#6 HD)	100
643	#8 X 2" (#6 HD)	100
646	#8 X 2-1/2" (#6 HD)	50
654	#10 X 3/4"	100
2597	#10 X 3/4" (#6 HD)	100
655	#10 X 3/4" (#8 HD)	100
656	#10 X 1"	100
657	#10 X 1-1/4" (#6 HD)	100
658	#10 X 1" (#6 HD)	100
659	#10 X 1" (#8 HD)	100
660	#10 X 1-1/2" (#6 HD)	100
2412	#10 X 1-3/4" (#6 HD)	100
663	#10 X 2-1/2" (#8 HD)	50
670	#12 X 1"	100

PHILLIPS PAN HEAD-ZINC-A/AB



<u>PART NO.</u>	<u>SIZE</u>	<u>UNIT PACKAGE</u>
680	#6 X 1/2"	100
2389	#6 X 1"	100
682	#8 X 1/2"	100
2390	#8 X 3/4"	100
2802	#8 X 3/4"	50
	(CHROME PLATED WITH SEALER)	
667	#8 X 1"	100
2454	#8 X 1"	100
	(CHROME PLATED)	
2260	#8 X 1-1/8" (#6 HD.)	100
	(CHROME PLATED)	
2781	#10 X 3/8"	100
	(4.8 X 9.5MM) POZIDRIVE	
	(OE-W504260) ZINC/YELLOW	
684	#10 X 1/2"	100
685	#10 X 5/8"	100
686	#10 X 3/4"	100
689	#10 X 1"	100
2391	#10 X 1-1/2"	100
3096	#10 X 1-3/4"	100
2392	#10 X 2"	100
687	#12 X 1/2"	100
2393	#12 X 3/4"	100
2394	#12 X 1"	100
2395	#12 X 1-1/2"	100
2396	#14 X 3/4"	100
2397	#14 X 1"	100
683	#14 X 1-3/4"	50

PHILLIPS FLAT HEAD NICKEL PLATED-A



<u>PART NO.</u>	<u>SIZE</u>	<u>UNIT PACKAGE</u>
620	#6 X 3/8" (#5 HD)	100
621	#6 X 1/2"	100
622	#8 X 3/8" (#5 HD)	100
	(ZINC PLATED)	

SLOTTED PAN HEAD-ZINC PLATED-A



<u>PART NO.</u>	<u>SIZE</u>	<u>UNIT PACKAGE</u>
501	#6 X 3/8"	100
505	#6 X 1"	100
509	#8 X 3/8"	100
537	#14 X 3/4"	100

SHEET METAL SCREWS-BRIGHT

**PHILLIPS OVAL FINISHING SEMS-AB
SHEET METAL SCREWS-CHROME PLATED
COUNTERSUNK WASHER (All #6 Head)**



<u>PART #</u>	<u>SIZE</u>
1651	#8 X 5/8"
1652	#8 X 3/4"
1653	#8 X 1"
1659	#10 X 1"

EACH NUMBER UNIT PKG.-100

**PHILLIPS OVAL CHROME
SHEET METAL SCREWS**



<u>PART #</u>	<u>SIZE</u>	<u>UPKG.</u>
2498	#8 X 3/4" (#6 HD.)-AB	100
2499	#8 X 3/4"-A	100
2500	#8 X 1" (#6 HD.)-AB	100
2763	#8 X 1"-AB (OE-11501867)	100
2513	#8 X 1-1/4" (#6 HD.)-A	100
2501	#8 X 1-1/2" (#6 HD.)-A	100

METRIC TORX HEAD TAPPING SCREWS-AB

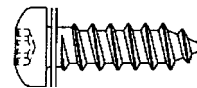

<u>PART #</u>	<u>SIZE</u>	<u>HEAD STYLE</u>	<u>OE NUMBER</u>	<u>FINISH</u>	<u>UPKG.</u>
2744	4.2 X 13MM	PAN	11504646	BRIGHT (STAINLESS STEEL)	50
2745	4.2 X 16MM	PAN	11508879	BLACK (STAINLESS STEEL)	50
2184	4.2 X 20MM	OVAL	11504069	CHROME	50
2185	4.2 X 20MM	OVAL	11504659	BLACK OXIDE	50
2186	4.2 X 20MM	PAN	11504647	CHROME	50
2187	4.2 X 20MM	PAN	11504665	BLACK OXIDE	50
2746	4.2 X 20MM	PAN	11505204	BLACK	50
3314	4.2 X 30MM	OVAL	11504522	CHROME (STAINLESS STEEL)	50
2189	4.2 X 30MM	OVAL	11504656	BLACK OXIDE	50
2240	4.2 X 50MM	PAN	11504654	BLACK OXIDE	25
3236	#10-16 X 3/4"	PAN	6034912	BLACK	100

SHEET METAL SCREWS STAINLESS STEEL

3052



M6.3-2.54 X 16 MM (#14 X 5/8")
PHIL. OVAL HEAD
SHEET METAL SCREW
TYPE "A"
STAINLESS STEEL-BLACK
UNIT PKG.-50

2842



#8 X 1"
PHIL. OVAL HEAD
SHEET METAL SCREW-TYPE "AB"
STAINLESS STEEL
CHROME
UNIT PKG.-50

2843



#8 X 1-1/2"
PHIL. OVAL HEAD
SHEET METAL SCREW
TYPE "AB"
STAINLESS STEEL
CHROME
UNIT PKG.-50

SHEET METAL SCREWS - SELF DRILLING

**UNSLOTTED HEX WASHER HEAD
SELF DRILLING, SELF TAPPING
ZINC PLATED**



<u>PART #</u>	<u>SIZE</u>	<u>UPKG.</u>
2409	#8 X 1/2"	100
2150	#8 X 3/4"	100
2659	#8 X 1"	100
3379	#8 X 1-1/2"	50
2620	#10 X 1/2"	100
2660	#10 X 3/4"	100
2275	#10 X 1"	50
2764	#12 X 3/4"	100
2765	#14 X 3/4"	100
2486	#14 X 1"	25
3068	#14 X 1-1/4"	25
3069	#14 X 1-1/2"	25

**PHILLIPS OVAL HEAD-SELF DRILLING
FINISHING SCREWS WITH LOOSE
COUNTERSUNK WASHER**

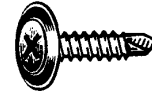

<u>PART #</u>	<u>SIZE</u>	<u>FINISH</u>
2996	#8 X 3/4"	CHROME
2997	#8 X 3/4"	BLACK
2998	#8 X 1"	CHROME
2999	#8 X 1"	BLACK
3000	#10 X 1"	CHROME
3001	#10 X 1"	BLACK

EACH NUMBER UNIT PKG.-50

**PHILLIPS PAN HEAD
SELF DRILLING POINT
ZINC**

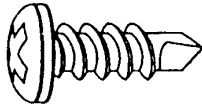

<u>PART #</u>	<u>SIZE</u>	<u>UPKG.</u>
2657	#8 X 1/2"	100
2658	#8 X 1"	100

**PHILLIPS FLAT TOP
WASHER HEAD
SELF DRILLING-BLACK
(11 MM WASHER DIAM.)**

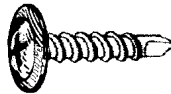

<u>PART #</u>	<u>SIZE</u>	<u>UPKG.</u>
2796	4.2 X 16	100
2797	4.2 X 19	100
2798	4.2 X 25	100

**PHILLIPS OVAL HEAD-SELF DRILLING
FINISHING SCREWS
WITH LOOSE FLUSH-TYPE WASHER**



2463-4.2 x 20 MM -ZINC(OE11502470)
(NOTE: 4.2 X 20MM = #8 X 3/4")
2484-4.2 X 20 MM-BLACK(OE11509707)
2733- #8 X 1-1/2" (#6 HD.)- BLACK
2734- #8 X 1-1/2" (#6 HD.)- ZINC
2735- #10 X 3/4" (#6 HD.)- BLACK
2736- #10 X 3/4" (#6 HD.)- ZINC
2738- #10 X 1" (#6 HD.)- ZINC

EACH NUMBER UNIT PKG.-50

2482



(9436165)
#8 X 7/8" PHILLIPS ROUND WASHER HEAD SCREW
(13/32" WASHER O.D.)
TEKS POINT-ZINC, CHRYSLER & UNIVERSAL
UNIT PKG.-100

3015



4.2-1.41 X 20 MM
INDENTED HEX WASHER HEAD-SELF
DRILLING SCREW WITH ATTACHED 12 MM
LOOSE WASHER; 7 MM HEX-BLACK
UNIT PKG.-50

3016

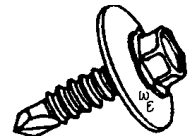

4.2-1.41X20MM
INDENTED HEX WASHER HEAD-
SELF DRILLING SCREW WITH ATTACHED 16 MM
LOOSE WASHER; 7 MM HEX-BLACK
UNIT PKG.-50

SHEET METAL SCREWS

HEX HEAD-A ZINC PLATED



<u>PART #</u>	<u>SIZE</u>	<u>UPKG.</u>
575	#8 X 1/2"	100
593	#10 X 1-1/2" (5/16" HD)	100
579	#12 X 3/4"	100
580	1/4" X 3/4" (7/16" HD)	100
582	1/4" X 1" (7/16" HD)	100
586	1/4" X 1-1/2" (7/16" HD)	100
587	#14 X 2" (3/8" HD)	100
588	5/16" X 3/4" (1/2" HD)	50
590	5/16" X 1" (1/2" HD)	50

UNSLOTTED HEX WASHER HEAD-AB BLACK

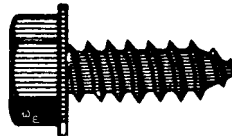

<u>PART #</u>	<u>DESCRIPTION</u>	<u>UPKG.</u>
2488	4.2 X 20 MM (7MM HEX) (9MM WASHER;OE-11503552, 11502836, 11509737)	100
598	#14X 5/8" (3/8" HD)	100
596	5/16" X 5/8"	50
597	5/16" X 7/8"	50

SLOTTED HEX WASHER HEAD-AB ZINC PLATED



<u>PART #</u>	<u>SIZE</u>	<u>UPKG.</u>
601	#8 X 3/8"- 1/4" HD A/F	100
602	#8 X 3/4"- 1/4" HD A/F	100
599	#10 X 5/8"- 5/16" HD A/F	100
603	#10 X 1"- 5/16" HD A/F	100
2203	#14 X 3/4"- 3/8" HD A/F	50

UNSLOTTED HEX WASHER HEAD-A ZINC PLATED

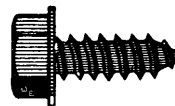

<u>PART #</u>	<u>DESCRIPTION</u>	<u>UPKG.</u>
2520	#8 X 3/8" (1/4" HD-A/F) (OE-9415191) (21/64" WASHER O.D.)	100
2783	4.2 X 13MM (7MM HEX) (OE-11509185) (STAINLESS STEEL; 9MM WASHER O.D.)	50
2803	#10 X 5/8" (3/32" HEAD) (OE-9417855)	100
2591	#10 X 1-1/2" (5/16" HD A/F) (13/32" WASHER O.D.)	100

2519
(6033006)







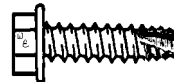





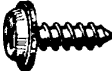

#10 X 5/8" UNSLOTTED HEXWASHER HD
SCREW W/SEALER(5/16" HEX; 7/16" WASHER)
CHRYSLER & UNIVERSAL
BLACK PHOSPHATE
UNIT PKG.-50

2271
(OE-943355)

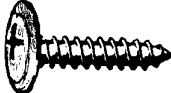

#10 X 3/4"
HEX WASHER HEAD THREAD CUTTING SCREW-TYPE 25
FRONT FASCIA, HDLMP&GRILLE MOUNTING
CHRYSLER-BLACK
UNIT PKG.-50

SHEET METAL SCREWS

<p>625 </p> <p>#8 X 3/8" (#6 HEAD) (3/8" WASHER DIAMETER) PHILLIPS OVAL WSHR HEAD SELF TAPPING SCREW WHEEL OPENING MOULDING SCREW UNIVERSAL ZINC UNIT PKG.-100</p>	<p>671 </p> <p>#5-20 X 3/8" (7/32" HEAD) PHILLIPS FLAT HD SCREW USE WITH PLASTIC MOULDING CLIPS, LANDAU CLIPS (W&E #345) UNIVERSAL ZINC UNIT PKG.-100</p>	<p>672 </p> <p>#8 X 3/8" PHILLIPS WASHER HEAD SCREW FOR ATTACHING WINDSHIELD & REAR WINDOW REVEAL MOULDING CLIPS (LOW PROFILE HEAD; 9/32" WASHER O.D.) CHRYSLER & UNIVERSAL- ZINC UNIT PKG.-100</p>
<p>2222 </p> <p>(6030539), (9616231), (38439 S47) #8 X 1/2" (3/8" WASHER DIAMETER) PHILLIPS OVAL WASHER HEAD SELF DRILLING SCREW WHEEL OPENING MOULDING SCREW GM & UNIVERSAL ZINC UNIT PKG.-100</p>	<p>2259 </p> <p>(11501794) 4.2 X 12 MM (#8 X 1/2") (25/64" WASHER DIAM.) PHILLIPS OVAL WASHER HEAD SCREW BODY SIDE MOULDING SCREW/ FRONT END ORNAMENT, WHEELHOUSE CHROME PLATED UNIT PKG.-100</p>	<p>2403 </p> <p>#8 X 1/2" PHILLIPS ROUND WASHER HEAD SHEET METAL SCREW WITH SEALER (23/64" WASHER OD) ZINC UNIT PKG.-50</p>
<p>2382 </p> <p>#8 X 1/2" PHILLIPS TRUSS HEAD (TYPE 17 PT.) THREAD CUTTING WHEELHOUSE SCREW ZINC UNIT PKG.-100</p>	<p>2404 </p> <p>#10 X 1/2" PHILLIPS ROUND WASHER HEAD SHEET METAL SCREW WITH SEALER (27/64" WASHER OD) ZINC UNIT PKG.-50</p>	<p>2341 </p> <p>4.2 X 20 MM (#8 X 3/4") PHILLIPS FLAT WASHER HEAD SCREW (7/16" WASHER OD) ZINC UNIT PKG.-100</p>
<p>2860 </p> <p>(REPLACES GM-11501883) PHILLIPS FLAT WASHER HEAD, SHEET METAL SCREW-AB POZIDRIVE 4.2 X 13 MM (#8 X 1/2")-11 MM WASHER DIAMETER ZINC UNIT PKG.-100</p>	<p>2450 </p> <p>#8 X 5/16" PHILLIPS ROUND WASHER HEAD SCREW (27/64" WASHER OD) CHROME PLATED UNIT PKG.-100</p>	<p>2447 </p> <p>#6 X 1/2" PHILLIPS FLAT HEAD SCREW (#4 HEAD SIZE)-ZINC UNIT PKG.-100</p>

CLIP NUTS

2346



"U" TYPE CLIP NUT
#6 SCREW SIZE
GENERAL PURPOSE-BLACK
PANEL RANGE-.025-.150"
UNIT PKG.-50

811



"U" TYPE CLIP NUT
#8 SCREW SIZE
GENERAL PURPOSE
PANEL RANGE-.025-.150"
UNIT PKG.-50

814

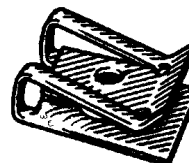

"U" TYPE CLIP NUT
#14 SCREW SIZE
GENERAL PURPOSE
PANEL RANGE-.025-.150"
UNIT PKG.-50

846



"U" TYPE CLIP NUT
#8A SCREW SIZE
GENERAL PURPOSE
PANEL RANGE-.055-.080"
UNIT PKG.-100

858

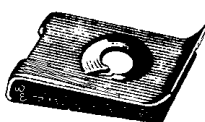

"U" TYPE CLIP NUT
#10A SCREW SIZE
GENERAL PURPOSE
PANEL RANGE-.025-.064"
UNIT PKG.-100

859



"U" TYPE CLIP NUT
#10A SCREW SIZE
HEADLAMP TO FENDER
PANEL RANGE-.025-.040"
BUICK
UNIT PKG.-50

852

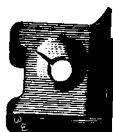

"U" TYPE CLIP NUT
#8A SCREW SIZE
HEADLAMP TO FENDER
PANEL RANGE-.025-.040"
FORD
UNIT PKG.-100

853

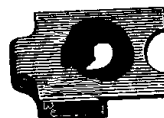

"J" TYPE CLIP NUT
#8A SCREW SIZE
FRONT FENDER ASSEMBLY
AND HEADLAMP TO FENDER
PANEL RANGE-.025-.040"
FORD
UNIT PKG.-50

860



"J" TYPE CLIP NUT
#14A (1/4") SCREW SIZE
FRONT END ASSEMBLY
PANEL RANGE-.051-.062"
GM, CHRYSLER, FORD
UNIT PKG.-100

861







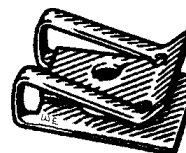

"U" TYPE CLIP NUT
#1/4-20 SCREW SIZE
LICENSE PLATE
PANEL RANGE-.064-.125"
ALL CARS
UNIT PKG.-100

2164

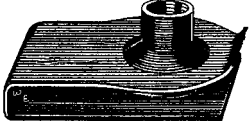
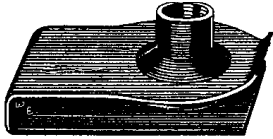

"U" TYPE CLIP NUT
#10A SCREW SIZE
GENERAL PURPOSE
WIDE PANEL RANGE
PANEL RANGE-.025-.150"
UNIVERSAL
UNIT PKG.-50

CLIP NUTS/ USS FOLD OVER NUTS & UNIVERSAL

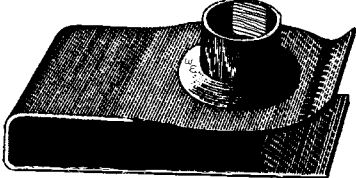
<p>2220</p>  <p>(10005510) CLIP NUT BUMPER IMPACT STRIP PONTIAC- '78 & UP GM "X" CARS- '80 & UP UNIT PKG.-50</p>	<p>2255</p>  <p>(9433155) "U" TYPE CLIP NUT LONG THROAT, WIDE RANGE #8A OR 4.2 MM SCREW SIZE PANEL RANGE-.025-.150" GM, FORD & UNIVERSAL UNIT PKG.-50</p>	<p>2708</p>  <p>(9433159) "U" TYPE CLIP NUT #14 SCREW SIZE WIDE RANGE (.125-.250") GM & UNIVERSAL UNIT PKG.-50</p>
<p>2751</p>  <p>(N 802538-S301) SPECIAL CLIP NUT #8 SCREW SIZE 1/16"- 5/32" PANEL RANGE FORD TAURUS/ WINDSTAR SILVER DACROMET PLATING UNIT PKG.-50</p>	<p>910 (FORD- 45263-S2)</p>  <p>1/4-20 USS "U" TYPE SPEED NUT SHORT THROAT GENERAL PURPOSE PANEL RANGE-.025-.150" UNIT PKG.-50</p>	<p>911</p>  <p>(45267) 1/4"-20 USS "U" TYPE SPEED NUT LONG THROAT GENERAL PURPOSE PANEL RANGE-.025-.150" UNIT PKG.-50</p>
<p>915</p>  <p>(GM-1494253) (FORD-45264-S2) 5/16"-18 USS "U" TYPE SPEED NUT GENERAL PURPOSE PANEL RANGE-.025-.150" UNIT PKG.-25</p>	<p>916</p>  <p>(1494258) 5/16"-18 USS "U" TYPE SPEED NUT LONG THROAT GENERAL PURPOSE PANEL RANGE-.025-.150" UNIT PKG.-25</p>	<p>2926</p>  <p>(CHRYSLER-6023168) "J" TYPE SPEED NUT 1/4-20 USS THREAD, 1/2" THROAT .04-.08" PANEL THICKNESS GENERAL PURPOSE UNIT PKG.-50</p>
<p>917</p>  <p>(FORD-45269) 3/8"-16 USS "U" TYPE NUT LONG THROAT PANEL RANGE-.050-.200" CENTER HOLE TO EDGE- 1-1/8" UNIT PKG.-10</p>	<p>3340</p>  <p>(90189-06131) PLASTIC U-CLIP ENGINE SHIELD RETAINER (18 X 30 MM O/A DIMENSIONS) (FOR #12 SCREW) TOYOTA PRIUS-'06 & UP UNIT PKG.-10</p>	

METRIC FOLD OVER NUTS-OEM & UNIVERSAL

5901

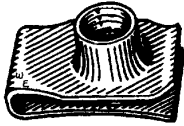

(11500658)
(11502785)
6.3-1.0 MM FOLDOVER NUT
GM CARS - '77 & UP
UNIT PKG.-50

5902

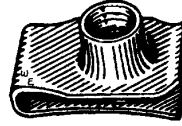

(GM-11508925), (GM-11500660)
(FORD-N623333-S2, N623333-S100)
8-1.25 MM METRIC FOLDOVER NUT
GM, FORD & UNIVERSAL
UNIT PKG.-25

5903

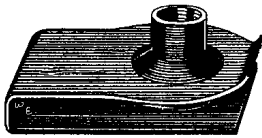

(11500661)
8-1.25 MM LONG THROAT METRIC
FOLDOVER NUT
GM- '77 & UP- UNIVERSAL
UNIT PKG.-25

5904

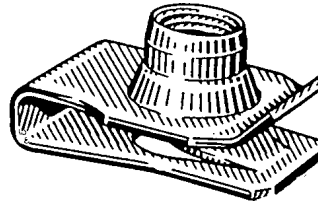

(11500662)
10-1.5 MM METRIC SPEED NUT
GM- '77 & UP- UNIVERSAL
UNIT PKG.-25

5920

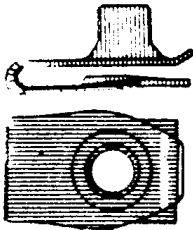

(1016937, 11503957, N623332)
6-1.0 MM METRIC SPEED NUT
LONG THROAT
GM- '79 & UP
FORD & UNIVERSAL
UNIT PKG.-50

5924

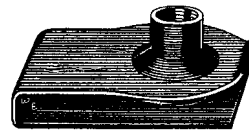

(11506099, 11503715, 11508241)
6-1.0 MM METRIC SPEED NUT
LONG THROAT
GM- "X" & "J" CARS &
UNIVERSAL
UNIT PKG.-25

5936

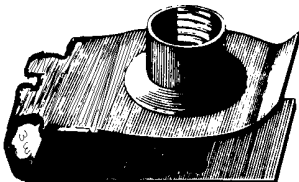



(6500626)
10-1.5 MM "U" NUT -"HEAVY DUTY"
ENGINE SUPPORT TO FRONT SIDE RACK
CHRYSLER & UNIVERSAL
UNIT PKG.-10

5989



(GM-11500656, 11505596)
(FORD-N623331-S2)
(CHRYSLER-6100040)
M5-0.8 METRIC FOLDOVER NUT
(0.6-3.8 MM PANEL RANGE)
(11.5 MM THROAT)
UNIT PKG.-25

METRIC BODY BOLTS-OEM & UNIVERSAL

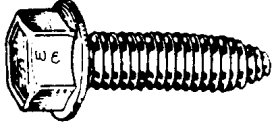
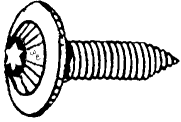
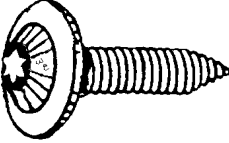
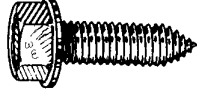
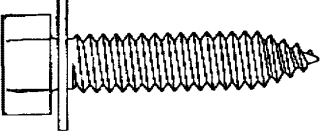
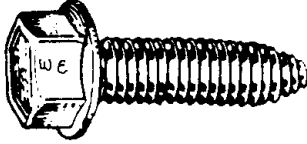
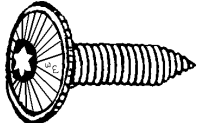
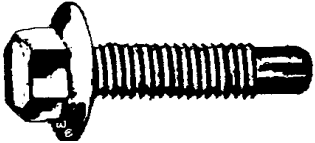
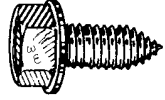
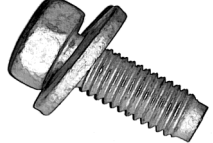
<p>3088</p>  <p>(GM 20033049) 8-1.25 X 35 MM INDENTED HEX WASHER HEAD BOLT 13 MM HEX 17 MM WASHER CAPTIVE POINT UNIT PKG.-25</p>	<p>5905</p>  <p>(11500961) 6.3-1.0 X 20 MM HEX WASHER HEAD BODY BOLT- CA PT. 10 MM HEX 13 MM WASHER GM & UNIVERSAL '77 & UP UNIT PKG.-50</p>	<p>5906 (11500970) (11503632)</p>  <p>8-1.25 X 25 MM BODY BOLT HEX WASHER HEAD; CA POINT 13 MM HEX 16 MM WASHER O.D. GM & UNIVERSAL- '77 & UP UNIT PKG.- 50</p>
<p>5953</p>  <p>6-1.0 X 20 MM TORX WASHER HEAD BODY BOLT- CA POINT 18 MM WASHER ZINC UNIT PKG.- 25</p>	<p>5954</p>  <p>6-1.0 X 30 MM TORX WASHER HEAD BODY BOLT- CA POINT 18 MM WASHER ZINC UNIT PKG.- 25</p>	<p>5967</p>  <p>(11503800) 6-1.0 X 20 MM HEX WASHER HEAD BODY BOLT- CA PT. 10 MM HEX 13 MM WASHER GM & UNIVERSAL '77 & UP UNIT PKG.-50</p>
<p>5980</p>  <p>(11515425) 8-1.25 X 35 MM INDENTED HEX HEAD BODY BOLT 17 MM LOOSE WASHER 13 MM HEX; CA POINT GM & UNIVERSAL-BLACK UNIT PKG.-25</p>	<p>5985</p>  <p>10-1.5 X 30 MM HEX WASHER HEAD BODY BOLT-CA POINT (15 MM HEX; 19 MM WASHER) BLACK UNIT PKG.-25</p>	<p>5987</p>  <p>6-1.0 X 20 MM TORX WASHER HEAD BOLT-CA POINT 16 MM WASHER O.D. BLACK UNIT PKG.-25</p>
<p>5988 (11515791)</p>  <p>8-1.25 X 35 MM HEX FLANGE HEAD (13 MM HEX; 17.5 MM FLANGE O.D.) BODY BOLT-DOG POINT GRADE 10.9 UNIT PKG.-15</p>	<p>3258 (16600199)</p>  <p>6-1.0 X 13 MM INDENTED HEX WASHER HEAD BODY BOLT-CA POINT (10 MM HEX; 13 MM WASHER O.D) GM-ZINC UNIT PKG.- 50</p>	<p>3401 (6505145AA)</p>  <p>8-1.25 X 23 MM BODY BOLT W/ ATTACHED LOOSE WASHER (13 MM HEX; 20 MM WASHER) HIGH CORROSION RESISTENCE DOG POINT-ALUM./ZINC CHRYSLER/DODGE- '05-UP UNIT PKG.-25</p>

METRIC BODY BOLTS-OEM & UNIVERSAL

3053

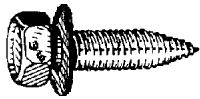

(11509440)
6-1.0 X 20 MM
UNSLOTTED HEX HD BODY BOLT
(12 MM LOOSE WSHR; 10 MM HEX)
CA POINT; GM
BLACK
UNIT PKG.-25

5947

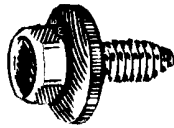

(11503941), (11503823)
6-1.0 X 20 MM BODY BOLT
INDENTED HEX HEAD
(17 MM LOOSE WSHR; 10MM HEX)
CA POINT- UNIVERSAL
GM-'82 & UP
UNIT PKG.-25

5976

(11509033)

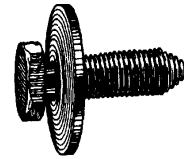

6-1.0 X 20 MM BODY BOLT
INDENTED HEX HEAD
(24 MM WASHER; 10 MM HEX)
CA POINT -BLACK
GM & UNIVERSAL
UNIT PKG.- 25

5923

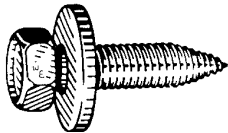

(11503834), (20351035)
6-1.0 X 25 MM BODY BOLT
INDENTED HEX HD; (17 MM LOOSE
WASHER; 10 MM HEX) CA POINT
(SMALLER WASHER THAN 5921)
GM, HONDA, NISSAN & TOYOTA
UNIT PKG.-25

5921

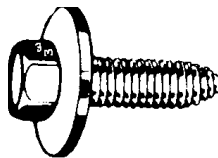

(11503982), (11504493)
6-1.0 X 25 MM BODY BOLT
INDENTED HEX HD WITH
24 MM LOOSE WASHER
CA POINT
GM & UNIVERSAL
UNIT PKG.-25

5962

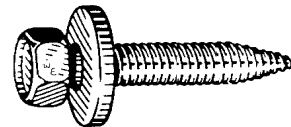

(11505044)
6-1.0 X 35 MM BODY BOLT
INDENTED HEX HEAD
17 MM WASHER; 10 MM HEX
CA POINT
GM & UNIVERSAL
UNIT PKG.- 25

5927

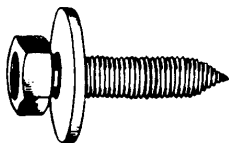

(11502970)
6.3-1.0 X 25 MM BODY BOLT
INDENTED HEX HEAD
WITH 16.5 MM LOOSE WASHER
CA POINT
GM-'77 & UP AND UNIVERSAL
UNIT PKG.-50

5910

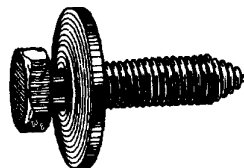

(11501188)
8-1.25 X 30 MM BODY BOLT
INDENTED HEX HEAD
WITH 24 MM LOOSE WASHER
CA POINT
GM-'77 & UP AND UNIVERSAL
UNIT PKG.-25

5955

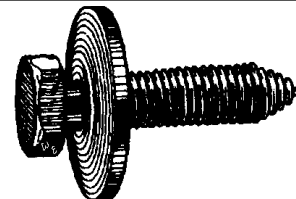

(11501189)
8-1.25 X 35 MM BODY BOLT
INDENTED HEX HEAD WITH 24
MM LOOSE WASHER; CA POINT
GM AND UNIVERSAL
BLACK
UNIT PKG.-15

5932

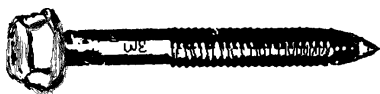

(PICTURE NOT ACTUAL SIZE)
(6500369)
8-1.25 X 55 MM BODY BOLT
HEX WASHER HEAD; CA POINT
CHRYSLER AND UNIVERSAL
UNIT PKG.-10

5911

(11501193)

10-1.50 X 40 MM BODY BOLT
INDENTED HEX HEAD
(15 MM HEX) WITH 28 MM
LOOSE WASHER ; CA POINT
GM-'77 & UP AND UNIVERSAL
UNIT PKG.-15

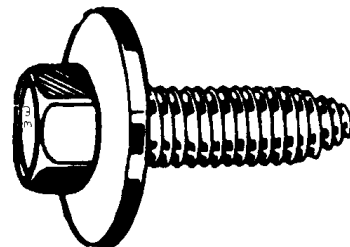

METRIC BODY BOLTS-OEM & UNIVERSAL

3102

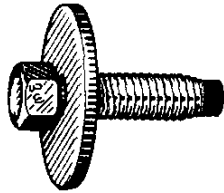

6-1.0 X 20 MM UNSLOTTED
INDENTED HEX HEAD BOLT
WITH 24 MM LOOSE WASHER
8 MM HEAD- DOG POINT

SILVER DACROMET

UNIT PKG.-25

5940

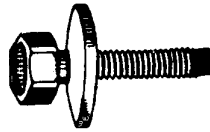

6-1.0 X 20 MM BODY BOLT
INDENTED HEX HEAD
WITH LOOSE WASHER 10 MM
HEX; 17 MM WASHER DIAM.
DOG POINT
UNIT PKG.-25

3259

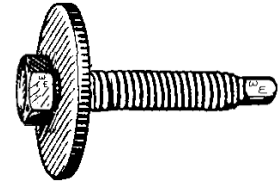

6-1.0 X 30 MM INDENTED
HEX BOLT (10 MM HEX)
WITH 24 MM LOOSE WASHER
DOG POINT (THREAD STARTER)

BLACK

UNIT PKG.- 25

3120

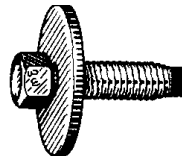

(GM-11516908)
6-1.0 X 20 MM
HEX HEAD BODY BOLT
24 MM LOOSE WASHER
10 MM HEX; DOG POINT
ZINC/ OLIVE PLATING
UNIT PKG.-25

3054

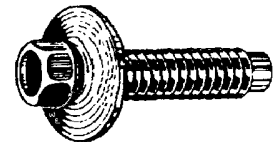

(FORD W503925-S36)

6-1.0 X 25 MM UNSLOTTED HEX
HEAD BODY BOLT WITH 19 MM
LOOSE WASHER; (8 MM HEX)
DOG POINT

ZINC/YELLOW

UNIT PKG.-50

5963

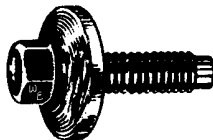

(N606676-S2)

6-1.0 X 22 MM BODY BOLT
INDENTED HEX HEAD 8 MM HEX
19 MM (3/4") WASHER DOG PT

FORD, CHRYSLER &
UNIVERSAL

UNIT PKG.- 50

3089

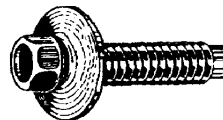

(GM 11515655)
6-1.0 X 25 MM
HEX HEAD BOLT
WITH 17 MM LOOSE
WASHER; 10 MM HEX
GM- BLACK
UNIT PKG.-25

5968

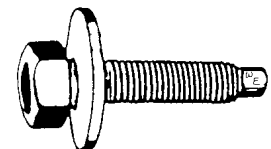

(6100568)

6-1.0 X 30 MM BODY BOLT
INDENTED HEX HEAD
(10 MM HEX); (19 MM LOOSE
WASHER)
DOG POINT
BLACK

CHRYSLER & UNIVERSAL

UNIT PKG.- 25

3319

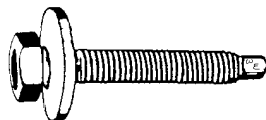

(W505416)
5-0.8 X 25 MM INDENTED HEX
HEAD BOLT (8 MM HEX) WITH 14.5
MM ATTACHED LOOSE WASHER
PILOT POINT
FORD & UNIVERSAL
BLACK
UNIT PKG.-25

5952

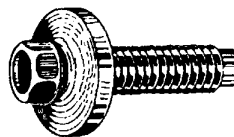

(N606677-S36)
6-1.0 X 28 MM BODY BOLT
INDENTED HEX HEAD (8 MM HEX)
WITH 19 MM LOOSE WASHER
DOG POINT-ZINC/YELLOW
PLATED; -FORD
UNIT PKG.-25

METRIC BODY BOLTS-OEM & UNIVERSAL

5991

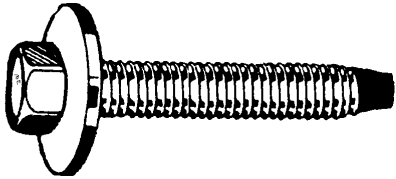

(11515923)
8-1.25 X 50 MM BODY BOLT
INDENTED HEX HD; (24 MM LOOSE
WASHER; 13 MM HEX) -DOG POINT
GM & UNIVERSAL
ZINC/ORGANIC PLATED

UNIT PKG.- 25

5977

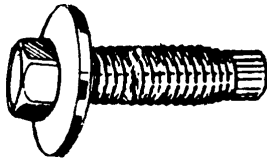

(20729795)
10-1.5 X 29 MM BODY BOLT
INDENTED HEX HD 28 MM
WASHER 15 MM HEX
GM & UNIVERSAL
BLACK

UNIT PKG.- 25

3121

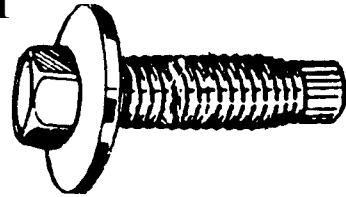

(GM11900338)
10-1.50 X 35 MM
HEX HEAD BODY BOLT
28 MM LOOSE WASHER
16 MM HEX; DOG-POINT
ZINC ORGANIC
UNIT PKG.-10

3321

(11517372)

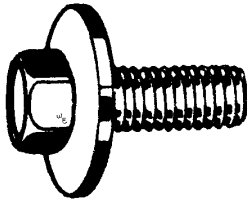

10-1.5 X 25 MM
HEX HEAD BODY BOLT (15 MM HEX)
WITH 28 MM LOOSE WASHER-ZINC PHOSPHATE-GM &
UNIVERSAL
UNIT PKG.-25

3320

(W505435)

8-1.25 X 30 MM
HEX HEAD BODY BOLT
(13 MM HEX) WITH 24 MM
LOOSE WASHER
PILOT POINT
FORD & UNIVERSAL
ZINC PHOSPHATE
UNIT PKG.-25

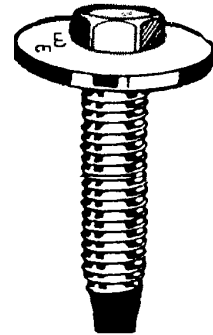

HEX HEAD BODY BOLTS- USS

940



1/4"-20 X 5/8" USS
5/8" WASHER O.D.
HEX WASHER HEAD
"GRIP LOCK" BOLT BLACK
GENERAL PURPOSE
UNIT PKG.-100

942

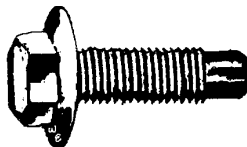

5/16"-18 X 1" USS HEX WASHER
HEAD "GRIP LOCK" BOLT
(51/64" WASHER O.D)
DOG POINT-BLACK
UNIT PKG.-25

943



(3960314)
5/16"-18 X 13/16" USS
HEX WASHER HEAD BOLT
(21/32" WASHER O.D.)
CA POINT
BLACK
UNIT PKG.-50

944

(3986997)
(14011722)

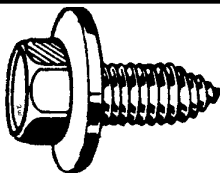

3/8-16 X 1" USS HEX HEAD BOLT
WITH 1" LOOSE WASHER; CA
PT HOOD HINGE TO FENDER
GM- '71-'76
UNIT PKG.-25

945

(407217),
(1564180)

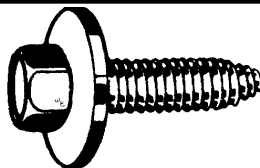





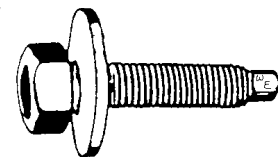

3/8"-16 X 1-1/2" USS HEX HEAD BOLT
CA POINT WITH 1-1/8" LOOSE
WASHER; 9/16" HEX
HOOD HINGE TO FENDER-GM- '71-'76
UNIT PKG.-25

2747

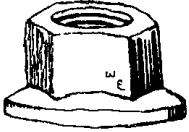

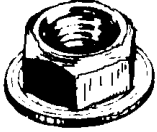
(06025334)
1/4"-20 X 1-1/4" BODY BOLT
(7/16" HEX; 3/4" LOOSE
WASHER)-DOG POINT
UNIT PKG.-50

FLANGE NUTS "GRIP LOCK" -BLACK FINISH

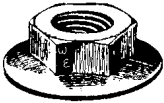
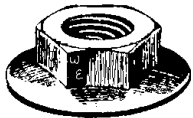
<p>5909 (11501850)</p>  <p style="text-align: center;">10-1.5 MM HEX FLANGE NUT (15 MM HEX); (21 MM FLANGE) GM & UNIVERSAL UNIT PKG.-25</p>	<p>5941</p>  <p style="text-align: center;">6-1.0 MM HEX FLANGE NUT (10 MM HEX) (13.5 MM FLANGE) UNIT PKG.-25</p>	<p>5931 (6500165) (11501889) (11514596)</p>  <p style="text-align: center;">8-1.25 MM HEX FLANGE NUT (13 MM HEX); (17 MM FLANGE) CHRYSLER, GM AND UNIVERSAL UNIT PKG.-25</p>
<p>5938 (11502702)</p>  <p style="text-align: center;">5-0.8 MM HEX FLANGE NUT (8 MM HEX); (11.5 MM FLANGE) GM & UNIVERAL UNIT PKG.-50</p>	<p>797</p>  <p style="text-align: center;">10-24 HEX FLANGE NUT (31/64" FLANGE) UNIT PKG.-100</p>	<p>798</p>  <p style="text-align: center;">1/4"-20 HEX FLANGE NUT (37/64" FLANGE) UNIT PKG.-100</p>
<p>799</p>  <p style="text-align: center;">5/16"-18 HEX FLANGE NUT (21/32" FLANGE) UNIT PKG.-100</p>	<p>800</p>  <p style="text-align: center;">3/8"-16 HEX FLANGE NUT (3/4" FLANGE) UNIT PKG.-50</p>	

FREE SPINNING WASHER NUTS

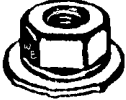
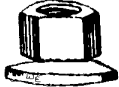
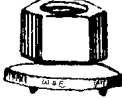
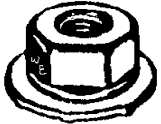
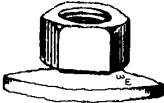
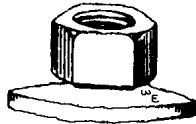
<p>5975</p>  <p style="text-align: center;">(N621901-S36) 4-0.7 MM NUT WITH FREE SPINNING 16 MM WASHER; 9 MM HEX-ZINC/YELLOW PLATING FORD & UNIVERSAL UNIT PKG.-25</p>	<p>5965</p>  <p style="text-align: center;">(N621903), (4200408) (11501099) 5-0.8 MM NUT WITH FREE SPINNING 15 MM WASHER; 10 MM HEX PHOS & OIL GM, FORD & UNIV. UNIT PKG.-25</p>	<p>5922</p>  <p style="text-align: center;">(VW-N90100001) (11503752), (11505329) 6-1.0 MM NUT WITH FREE SPINNING 16 MM WSHR 10 MM HEX PHOS & OIL VW, GM-'79 & UP UNIT PKG.-25</p>	<p>5948</p>  <p style="text-align: center;">(11503754), (11503756) (11505214), (6100049) 6-1.0 MM NUT WITH FREE SPINNING 19 MM WSHR 10 MM HEX PHOS & OIL GM & CHRYSLER UNIT PKG.-25</p>
<p>5983 (N621907-S55)</p>  <p style="text-align: center;">6-1.0 MM NUT WITH FREE SPIN. 24 MM WASHER; 11 MM HEX ZINC & BLACK FORD PRODUCTS UNIT PKG.-25</p>	<p>5908</p>  <p style="text-align: center;">(11500401), (11503695), (N621940) 8-1.25 MM NUT WITH FREE SPINNING 24 MM WASHER; 13 MM HEX- PHOS & OIL GM- '77 & UP; - FORD UNIT PKG.-25</p>		

BUMPER BOLTS LOCKING NUTS, RETAINERS

728 UNIT PKG.-25
729 UNIT PKG.-100

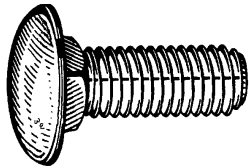

BUMPER BOLTS
3/8"-16 X 1"; ROUND HEAD
STAINLESS STEEL CAPPED
RAMBLER, CORVAIR, VALIANT

730 UNIT PKG.-20
731 UNIT PKG.-100

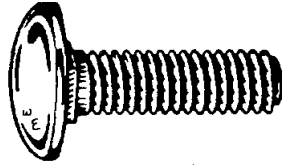

BUMPER BOLTS
7/16"-14 X 1" PAN HEAD
STAINLESS STEEL CAPPED
FALCON AND COMET

732 UNIT PKG.-20
733 UNIT PKG.-100

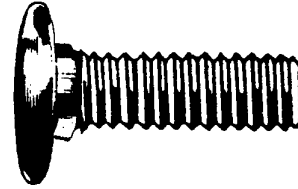

BUMPER BOLTS
7/6"-14 X 1-3/8" PAN HEAD
STAINLESS STEEL CAPPED
FALCON AND COMET

740 UNIT PKG.-25
741 UNIT PKG.-100

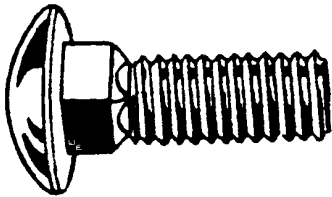

BUMPER BOLTS
1/2-13 X 1-1/2"; ROUND HEAD
STAINLESS STEEL CAPPED

5945
(14003784)
(N800744-S)

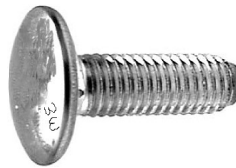

BUMPER BOLTS
8-1.25 X 25 MM
STAINLESS STEEL CAPPED
GM, FORD & UNIVERSAL

UNIT PKG.-15

2231

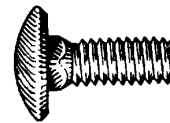

BUMPER BOLTS
1/4"-20 X 3/4"
STAINLESS STEEL CAPPED
USE FOR FOREIGN AND
U.S. COMPACT CARS

UNIT PKG.-25

REVERSIBLE HEX LOCKING NUTS- PLATED (ESPECIALLY ADAPTED FOR BUMPER BOLTS)

<u>PART NO.</u>	<u>SIZE</u>	<u>UNIT PKG.</u>	<u>PART NO.</u>	<u>SIZE</u>	<u>UNIT PKG.</u>
760	5/16-18	25	764	7/16"-14	25
761	5/16-18	100	765	7/16"-14	100
762	3/8-16	25	766	1/2"-13	25
763	3/8-16	100	767	1/2"-13	100

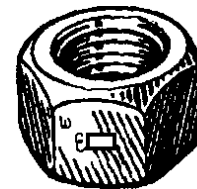

PUSH NUT BOLT RETAINERS

<u>PART NO.</u>	<u>OE #</u>	<u>BOLT SIZE</u>	<u>O.D.</u>	<u>UPKG.</u>
1050	6026648	3/8"	25/32"	100
1051	6026647	7/16"	27/32"	100
1052		1/2"	15/16"	100
5961	6501178, 6501792, N801192S36	6 MM	17 MM	100
5916		6.3 MM	13 MM	100
5917	11502504, 11502853	8 MM	16 MM	100
5925	10009923	8 MM	24 MM	100
5918		10 MM	20 MM	100
5919		12 MM	22 MM	100
5982	11504119	14 MM	25 MM	50



HEX MACHINE SCREW NUTS-PLATED

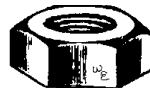
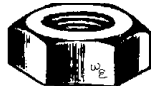

<u>PART #</u>	<u>SIZE</u>	<u>UNIT PKG.</u>
775	6-32	100
776	8-32	100
777	10-24	100
778	10-32	100
779	12-24	100
780	1/4-20	100

"E" CLIPS EXTERNAL RETAINING RINGS



<u>PART #</u>	<u>SHAFT DIAM</u>	<u>OUTSIDE DIAMETER</u>
2645	3/16"	.335
2646	1/4"	.527
2647	5/16"	.500
2648	3/8"	.660

EACH UNIT PKG.-100

3067

STUD CAP-WASHER STYLE
FOR 1/4" STUD, CAP DIAM.-9/32"
CAP HEIGHT-13/64", WASHER DIAM.-9/16"
BLACK PHOSPHATE
UNIT PKG.-100



FLAT NUTS (FOR USE WITH SHEET METAL SCREWS)



<u>PART NO</u>	<u>SCREW SIZE</u>
2572	#6
2573	#8
2574	#10

EACH UNIT PKG.-100

WASHER LOCKNUTS-PLATED



<u>PART NO.</u>	<u>SIZE</u>	<u>HEX HEAD</u>	<u>O.D.</u>
786	8-32	11/32"	5/8"
787	10-24	3/8"	1/2"
788	10-24	3/8"	3/4"
789	10-32	3/8"	1/2"
793	1/4-20	7/16"	13/16"

EACH UNIT PKG.-100

929

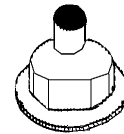

(6026686)
HEX WASHER HEAD
SELF THREADING NUT
1/4" STUD SIZE (3/4" FLANGE)
CHRYSLER & UNIVERSAL
UNIT PKG.-25

UNTHREADED STUD RETAINERS ZINC PLATED



<u>PART NO.</u>	<u>SIZE</u>	<u>(MM)</u>	<u>O.D.</u>	<u>(MM)</u>
2464	3/32"	(2.4)	3/16"	(4.8)
2465	1/8"	(3.2)	3/8"	(9.5)
2466	5/32"	(4.0)	7/16"	(11.1)
2467	3/16"	(4.8)	7/16"	(11.1)
2791	15/64"	(6.0)	17/32"	(13.5)
2468	1/4"	(6.4)	17/32"	(13.5)
2469	3/8"	(9.5)	3/4"	(19.0)

EACH UNIT PKG.-100



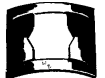







PUSH-ON CLIPS (FOR NAME PLATES, DUMMY BUMPER BOLTS, ETC.)







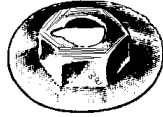
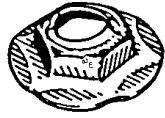
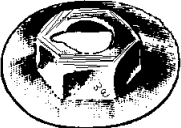

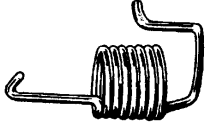
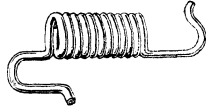

<u>PART NO</u>	<u>STUD SIZE</u>
885	1/16"
886	3/32"
887	1/8"
888	5/32"
889	3/16"
890	1/4"

EACH UNIT PKG.-100

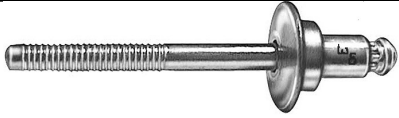
THREAD CUTTING NUTS/WASHER TYPE LOCK NUTS

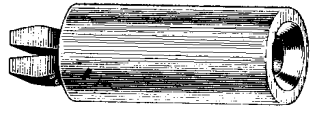
<p>920</p>  <p style="text-align: center;"> THREAD CUTTING NUT 1/8" STUD (17/32" FLANGE) UNIT PKG.-100 </p>	<p>921</p>  <p style="text-align: center;"> THREAD CUTTING NUT 3/16" STUD (9/16" FLANGE) UNIT PKG.-100 </p>	
<p>922</p>  <p style="text-align: center;"> THREAD CUTTING NUT 1/4" STUD (19/32" FLANGE) UNIT PKG.-100 </p>	<p>923</p>  <p style="text-align: center;"> THREAD CUTTING NUT 5/32" STUD (9/16" FLANGE) UNIT PKG.-100 </p>	
<p>2562 (REPLACES OE 11501836)</p>  <p style="text-align: center;"> THREAD CUTTING NUT 1/4" (6.3 MM) STUD; 7/16" HEX 11/16" (17.5 MM) WASHER O.D. (WIDER WASHER THAN W&E #922) ZINC PLATED UNIT PKG.-100 </p>	<p>2980 (20625733)</p>  <p style="text-align: center;"> WASHER LOCKNUT M5-1.6 THREAD DACROMET FINISH-GM 10 MM HEX 14 MM WASHER O.D. UNIT PKG.-50 </p>	<p>2790</p>  <p style="text-align: center;"> 6 MM WASHER TYPE LOCK NUT WITH SEALER 18 MM FLANGE DIAMETER BLACK UNIT PKG.-50 </p>
<p>5913</p>  <p style="text-align: center;"> (11502540) THREAD CUTTING NUT 4 MM STUD 15 MM FLANGE DIAMETER UNIT PKG.-100 </p>	<p>5914 (11501835,10062,11501932; SUB FOR 11508900)</p>  <p style="text-align: center;"> THREAD CUTTING NUT 5 MM STUD 15 MM FLANGE DIAMETER UNIT PKG.-100 </p>	<p>3184 (GM-15709267)</p>  <p style="text-align: center;"> M5-.8 WASHER TYPE LOCK NUT 10 MM HEX 18 MM WASHER DIAMETER BLACK UNIT PKG.-50 </p>
<p>5946</p>  <p style="text-align: center;"> (11502507) THREAD CUTTING NUT 8 MM STUD (20 MM FLANGE DIAMETER) BLACK UNIT PKG.-100 </p>	<p>5928</p>  <p style="text-align: center;"> (11503691) 6 MM WASHER TYPE LOCK NUT; (18 MM FLANGE) GM CARS UNIT PKG.-50 </p>	<p>5990</p>  <p style="text-align: center;"> THREAD CUTTING NUT FOR 3.2 MM (1/8") STUD 8 MM HEX 14 MM FLANGE DIAMETER UNIT PKG.-100 </p>

HEADLAMP SPRINGS, RETAINERS

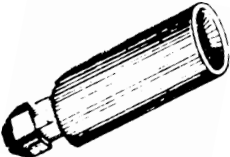
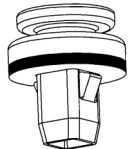
<p>1024</p>  <p>(555388, 554459) HEADLAMP ADJUSTING SPRING OLDSMOBILE: CUTLASS, DELTA 88 NINETY-EIGHT, TORONADO-'75-'77 UNIT PKG.- 10</p>	<p>2178</p>  <p>(D4ZZ-13031A) HEADLAMP ADJUSTING SPRING FORD: MUSTANG, GRANDA, TORINO-'74-'75 UNIT PKG.-10</p>	
<p>840</p>  <p>(E25B-13B160AA) HEADLAMP ADJUSTING RING BEARING FORD-'74-'76 UNIT PKG.-25</p>	<p>2888 (15022087)</p>  <p>HEADLIGHT RETAINER 1/4" ALL STEEL SHOULDER RIVET-ZINC (19/32" FLANGE DIAM., 25/64" SHOULDER DIAM.) (.047-.079: GRIP RANGE) GM BLAZER- '98 & UP UNIT PKG.- 10</p>	
<p>2179 (D5UZ-13031-A)</p>  <p>HEADLAMP ADJUSTING SPRING FORD: PINTO & MAVERICK-'75 UNIT PKG.-10</p>	<p>829 (3863669)</p>  <p>HEADLAMP TO GRILLE RETAINING NUT CHEVROLET UNIT PKG.-50</p>	
<p>830</p>  <p>(2524526) HEADLAMP DOOR RETAINING NUT (FOR #8-#10 SCREW) GM AND CHRYSLER UNIT PKG.-50</p>	<p>2383</p>  <p>(D5UB13B-160-AA) HEADLAMP ADJUSTING RING BEARING FORD-'75 & UP UNIT PKG.-50</p>	<p>842</p>  <p>(411847) HEADLAMP DOOR FASTENER & COVER, SPACER- TOGGLE TYPE .312 SQUARE HOLE, 1/2" COLLAR GM & UNIVERSAL UNIT PKG.-25</p>
<p>2143</p>  <p>(152867) HEADLAMP SPACER NYLON-1" LONG CHRYSLER PRODUCTS- '78 & UP UNIT PKG.-25</p>	<p>3392 (W713579-S300)</p>  <p>TAIL LAMP ASSEMBLY RETAINER WITH SEALER; (FOR 8MM SQ.HOLE; 15MM TOP HD DIAM.; 20MM O/A HT) FORD ESCAPE, EXPLORER & FOCUS;- LINCOLN MKS-'06& UP UNIT PKG.-10</p>	

HEADLAMP PARTS-NUTS, SCREWS AND RETAINERS

1011

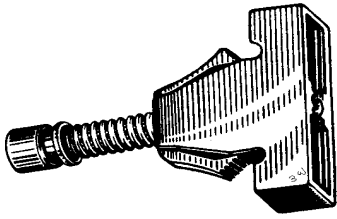

(556359, 557057, 556196)
**HEADLAMP ADJUSTING
 NUT AND SCREW**
 #12-28 X 1-3/4"
 GM- '77 & UP
 UNIT PKG.-10

1012

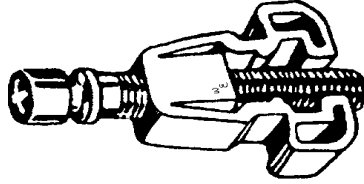

(1600375, 1606642)
**HEADLAMP ADJUSTING
 NUT AND SCREW**
 1/4"-28 X 2"
 GM-CADILLAC-'72 & UP
 UNIT PKG.-10

1013

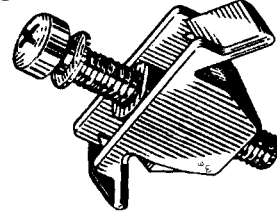

**HEADLAMP ADJUSTING
 NUT AND SCREW**
 CHRYSLER- '72 & UP
 UNIT PKG.-10

2116

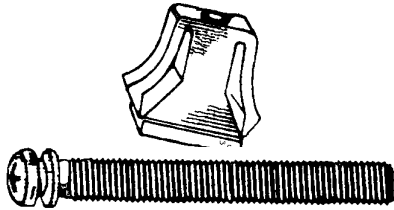

(365266, 365270)
**HEADLAMP ADJUSTING
 NUT AND SCREW**
 1/4"-28 X 2"
 (USE ON FIBERGLASS BUCKETS)
 GM- '75 & UP
 UNIT PKG.-10

2119

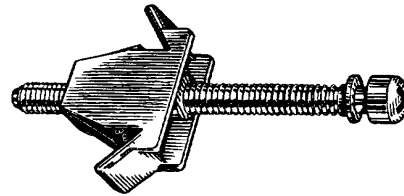

(5201359, 5201269, 3868985)
**HEADLAMP ADJUSTING
 NUT AND SCREW**
 #12-28 X 1-3/4"
 CHRYSLER- '77 & UP
 UNIT PKG.-10

2144

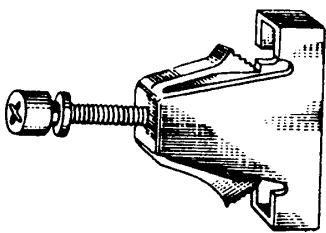

(D8BB-13A093AB)
**HEADLAMP ADJUSTING
 NUT AND SCREW**
 FORD- '78 & UP
 UNIT PKG.-10

1025

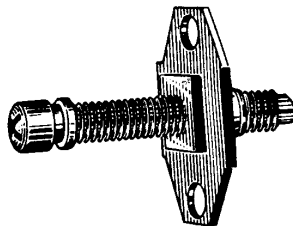

(D3AB-138093-AC)
**HEADLAMP ADJUSTING
 NUT AND SCREW**
 FORD- '73 & UP
 UNIT PKG.-10

1010



(3691599)
**HEADLAMP ADJUSTING
 NUT AND SCREW**
 (FIBERGLASS HDLMP BUCKETS)
 CHRYSLER- '74 & UP
 UNIT PKG.-10

1034

(1493541)
**HEADLAMP ADJUSTING
 NUT AND SCREW**
 GM- '69 & UP
 UNIT PKG.-10

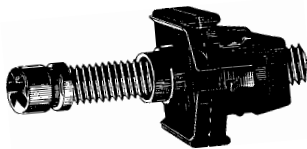

PLEASE CONTACT US
 WITH ANY QUESTIONS

WWW.WESALES.COM

HEADLAMP PARTS-NUTS, SCREWS AND RETAINERS

2456

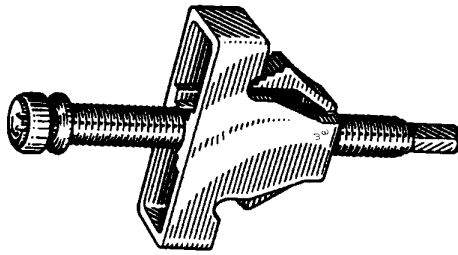

(4388249)
**HEADLAMP ADJUSTING
 NUT AND SCREW- TORX DRIVE 12-28 X 2-3/8"**
 CHRYSLER-VANS, MINIVANS '88 & UP
 UNIT PKG.-10

2535

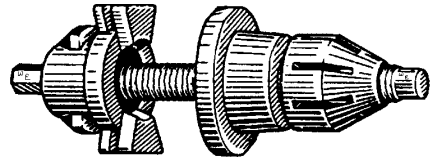

(F24B-13A093-BA)
 (E9DB-13A093-AA)
**REPLACES (E9DZ-13032-A)
 HEADLAMP ADJUSTING
 NUT AND SCREW**
 TAURUS & SABLE- '89 & UP
 UNIT PKG.-5

2235

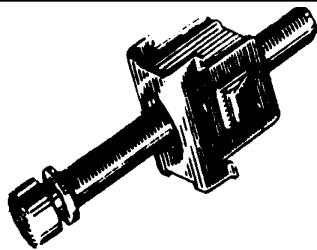

(E1EB 13A093AA)
 (E1TB 13A093AA)
**HEADLAMP ADJUSTING
 NUT AND SCREW**
 FORD BRONCO, ECONOLINE,
 LT TRUCKS, ESCORT, RANGER,
 & LYNX-'77 & UP
 UNIT PKG.-10

2268

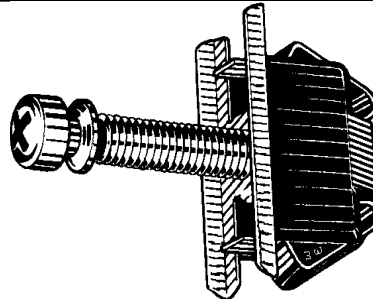

(E3DB-13A093AF), (E3DZ-13032A, 13032C)
**HEADLAMP ADJUSTING
 NUT AND SCREW**
 T-BIRD, COUGAR, FORD LTD,
 MERCURY MARQUIS, TEMPO & TOPAZ
 -'83 & UP
 UNIT PKG.-5

835

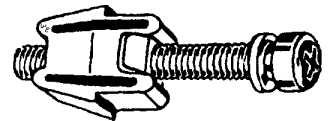

**HEADLAMP ADJUSTING
 NUT AND SCREW**
 CHRYSLER PRODUCTS
 UNIT PKG.-10

2124
 (365270)

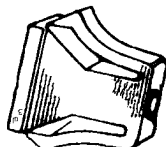

**HEADLAMP
 ADJUSTING NUT**
 USE ON FIBERGLASS BUCKETS
 NYLON-GREEN
 GM- '75 & UP
 UNIT PKG.-50

839

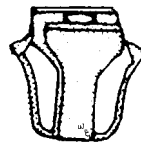

(354076, 343541, 343542)
HEADLAMP ADJUSTING NUT
 USE WITH W&E #1040
 GM- '75 & UP
 UNIT PKG.-25

837

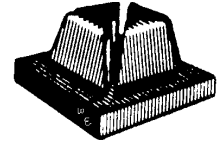

(3921446)
HEADLAMP ADJUSTING NUT
 THREAD SIZE 1/4-28
 GM
 UNIT PKG.-50

1040



(343543, 354076)
HEADLAMP ADJUSTING SCREW
 1/4-28 x 2" (GM & UNIVERSAL)
 USE WITH W&E #S 837, 839 & 2124
 UNIT PKG.-25

1041



HEADLAMP ADJUSTING SCREW
 #12-28 x 1-3/4"
 (GM, CHRYSLER & UNIVERSAL)
 UNIT PKG.-25

HEADLAMP PARTS-NUTS, SCREWS AND RETAINERS

2534

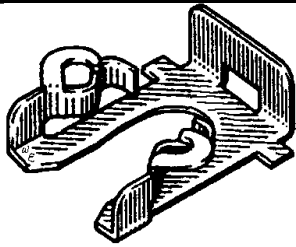

(E9DZ-13N129-A
F2AB-13N020-AA
(REPLACES-E9DB-13N020-AA)
HEADLAMP RETAINER
TAURUS, SABLE, T-BIRD, TEMPO,
TOPAZ, ECONOVAN
UNIT PKG.-15

2580



(PICTURE NOT ACTUAL SIZE)

(16508139, 16504937,
16505374,16506582)
HEADLAMP ADJUSTING
GEAR ASSEMBLY
GM:CHEV.,OLDS,PONT.-'86 & UP
UNIT PKG.-1

3237

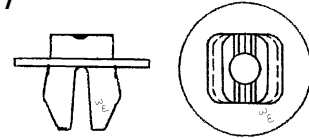

(90189-05142)
PLASTIC SCREW GROMMET
HEADLAMP ASSEMBLY
GRILLE RETAINER
FOR 9 MM HOLE
17 MM FLANGE DIAMETER
TAKES 4.2 MM (#8) SCREW
TOYOTA LEXUS-2001 & UP
UNIT PKG.-25

2700

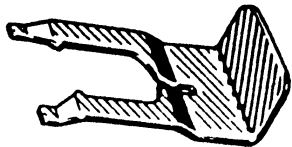

(F37-13N129A)
HEADLAMP RETAINER
ADJUSTING BAR TO HEADER PANEL
FORD RANGER-'93 & UP
UNIT PKG.-25

2211



DATSUN-(26022-H1010)
TOYOTA-(81131-12150)
(E3DZ-13032A, 13032C)
HEADLAMP ADJUSTING SCREW
5 MM X 40 MM
UNIT PKG.-25

2212

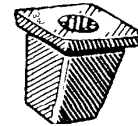

(26023-H1000)
HEADLAMP ADJUSTING
NUT-DATSUN
UNIT PKG.-25

2610

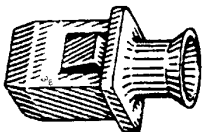

(8131-89103)
HEADLAMP ADJUSTING NUT
USES 5 MM SCREW
TOYOTA TRUCKS- '84 & UP
UNIT PKG.-10

2611

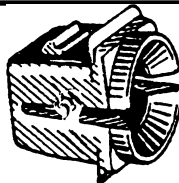

(81132-32121, 81127-01010,
95900-08025)
HEADLAMP ADJUSTING NUT
FOR 13 MM X 16 MM HOLE
TOYOTA- '88 & UP
UNIT PKG.-10

2248

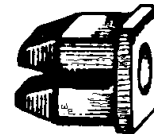

(90189-05013), (MS-480002)
HEADLAMP ADJUSTING NUT
12 MM SQUARE HD; #8-10 SCREW
FOR 9 MM HOLE
TOYOTA & MITSUBISHI
UNIT PKG.-25

832



(3880632)
HEADLAMP DOOR
UPPER RETAINER
GM
UNIT PKG.-50

844











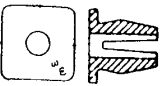

(3986978)
HEADLAMP BEZEL NUT
CHEVROLET- '71-'77
UNIT PKG.-25

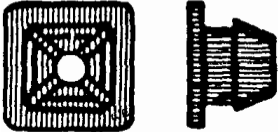
2338

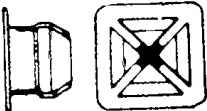

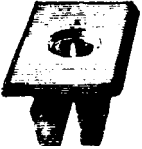
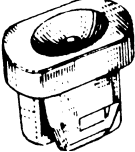
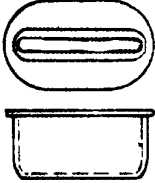
(VW-179-813-883),
(REP. GM-1355003), (1370853)
HEADLAMP BEZEL NUT
9.5 MM SQUARE HD; #6 SCREW
FOR 6.5 MM HOLE
VW, GM, RENAULT
& UNIVERSAL
UNIT PKG.-50

NUTS, GROMMETS, RETAINERS

<p>815 </p> <p>(6010082) HEADLAMP DOOR NUT (3/8" SQ. HD; #8-10 SCR. .266" HOLE) FORD, DODGE, PLYMOUTH DODGE TRUCKS</p> <p style="text-align: center;">UNIT PKG.-100</p>	<p>817 </p> <p>(3919773, 3893980) PLASTIC SCREW NUT GRILLE ATTACHING .300" HOLE</p> <p style="text-align: center;">UNIT PKG.-100</p>	<p>818 </p> <p>(3907444), (379046-S) LICENSE PLATE NUT-UNIVERSAL (USE #14 SCREWS) (W&E 537, 2203, 2326, 2547)</p> <p style="text-align: center;">UNIT PKG.-50</p>
<p>819 </p> <p>(379830-S) HEADLAMP DOOR NUT SIDE MIRROR TO DOOR GRILLE NUT (1/4" HOLE) (USE #8-10 SCREWS)</p> <p style="text-align: center;">UNIT PKG.-50</p>	<p>822 </p> <p>GRILLE SCREW NUT (.325" HOLE) (USE #8-10 SCREWS) CHEVY, BUICK & UNIVERSAL</p> <p style="text-align: center;">UNIT PKG.-100</p>	<p>825 </p> <p>(1355603), (3783004), (3783006) HEADLAMP DOOR NUT LICENSE PLATE NUT (USE #10 SCREWS) GM, RAMBLER</p> <p style="text-align: center;">UNIT PKG.-50</p>
<p>826 </p> <p>(1196781), (4755299) GRILLE TO RADIATOR, LIC. PLATE, HD LMP ADJ. NUT 5/8" SQUARE HD; #12-14 SCREW 11/32" OVERALL HEIGHT FOR 3/8" HOLE GM, FORD & UNIVERSAL</p> <p style="text-align: center;">UNIT PKG.-50</p>	<p>2101 </p> <p>(6030519) GRILLE NUT CHRYSLER & UNIVERSAL</p> <p style="text-align: center;">UNIT PKG.-50</p>	<p>2173 </p> <p>(1377030) RETAINER-BUMPER TO VALANCE BAR PANEL RETAINER-PONTIAC HEADLAMP SCREW -CHEVY UNIVERSAL</p> <p style="text-align: center;">UNIT PKG.-50</p>
<p>2208 </p> <p>(14013246)</p> <p>PLASTIC NUT HEADLAMP DOOR HEADER PANEL & SIDE LAMP (FOR #6-#8 SCREW; 5/16" ROUND HOLE; 31/64" SQ. HD)</p> <p style="text-align: center;">GM-'80 & UP UNIT PKG.-50</p>	<p>2210 </p> <p>(FORD-61A-1808-0019) (6031138), (6031234) PLASTIC NUT HEADLAMP & GRILLE CHRYSLER-'77 & UP, FORD</p> <p style="text-align: center;">UNIT PKG.-50</p>	<p>2213 </p> <p>(N800503S) PLASTIC CLIP NUT FRONT FENDER & DASH</p> <p style="text-align: center;">FORD-'79 & UP UNIT PKG.-50</p>

NUTS, GROMMETS, RETAINERS

2214



(386122S)
 NYLON NUT
 FOR 15/64" HOLE
 3/8" HEAD O.D.
 TAKES #8 SCREW
 (LARGER THAN W&E #819)
 FORD & UNIVERSAL
 UNIT PKG.-50

2236



(901894042, 95900-04036), (96706B0700)
 (75522-611-0000), (9991-00412)
 (MS-480001)
 PLASTIC NUT- SIDE MARKER LAMP
 9.5 MM SQUARE HEAD; #6 SCREW
 8 MM OVERALL HEIGHT
 6.4 MM HOLE
 TOYOTA, NISSAN, HONDA, MAZDA,
 MITSUBISHI AND UNIVERSAL
 UNIT PKG.-100

2244



(3919773, 347347)
 PLASTIC SCREW NUT
 HEADLAMP BEZEL-GM
 UNIT PKG.-50

2247



(22514578)
 PARKING LAMP ASSEMBLY
 NUT-PLASTIC
 (FOR THIN PANELS)
 GM & UNIVERSAL
 UNIT PKG.-25

2277

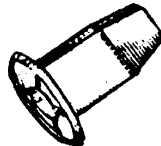

(96706-U0100), (90189-06001)
 (01281-00023), (MB-098145)
 PLASTIC SCREW GROMMET
 FOR 9 MM SQUARE HOLE
 18 MM HEAD; #10 SCREW
 19 MM OVERALL HEIGHT
 TOYOTA, NISSAN, MITSUBISHI
 UNIT PKG.-25

2305

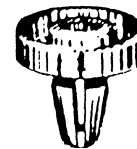

(5118-1852-299)
 PLASTIC NUT TYPE
 FASTENER-BMW
 UNIT PKG.-25

2339

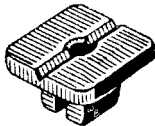

(6825-H 5000)
 (90662-671-0030)
 (9991-00-503)
 PLASTIC NUT
 GENERAL USAGE
 NISSAN, HONDA, MAZDA
 UNIT PKG.-25

2374

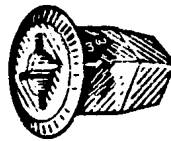

(90661-SC7-0030; 90189-06042; 01651-
 00481; 74798-S9000; H001-50-841)
 PLASTIC SCREW GROMMET
 FOR 9 MM SQUARE HOLE
 #10 SCREW; 16 MM HEAD O.D.
 19 MM OVERALL HEIGHT
 HONDA, TOYOTA, NISSAN, MAZDA
 UNIT PKG.-25

2381

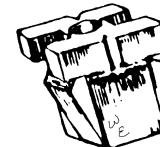

(90189-04008)
 (MB029-111), (94841130)
 GRILLE NUT/ GROMMET
 TOYOTA, MITSUBISHI
 GM-NOVA '85
 UNIT PKG.-20

2406



(14032291)
 GRILLE NUT-GROMMET
 7.5 MM HOLE
 GM
 UNIT PKG.-50









2473

(90189-04013)

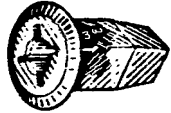

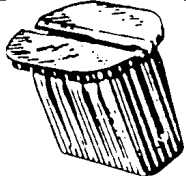
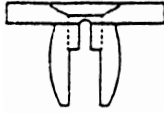
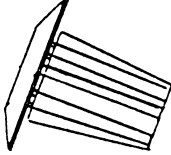
SCREW GROMMET
 7.8 MM HOLE
 14 MM HEAD DIAMETER
 16 MM OVERALL LENGTH
 TOYOTA
 UNIT PKG.-25

NUTS, GROMMETS, RETAINERS

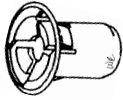
<p>2479</p>  <p>(171-853-615A) NAME PLATE GROMMET 7 MM HOLE 10 MM O/A LENGTH VW-'80 & UP</p> <p>UNIT PKG.-25</p>	<p>2494 (90189-06013)</p>  <p>(REPL.-TOYOTA-90189-06065) (29818-474D3; 96706-W1000) PLASTIC GROMMET FENDER SHIELD 6.3 MM (#14) SCREW SIZE 20 MM HEAD; 8 X 8 MM HOLE TOYOTA</p> <p>UNIT PKG.-20</p>	<p>2502</p>  <p>(96706-H9400, K1300,1351) (90686-SBO-003), (90189-04033) (B033-68-805), (MB 106212) NYLON SCREW GROMMET FOR 7 MM SQUARE HOLE 13 MM HEAD O.D. 12 MM OVERALL HEIGHT TAKES #8 SCREW MDZA,NISS,HONDA,MITS,TOYOTA</p> <p>UNIT PKG.-25</p>
<p>2503</p>  <p>(9991-00-601), (91619-SA5-003) (96706-P0105), (901-89-06010) NYLON SCREW GROMMET 13 MM SQ. HD, #10 SCREW, 10 MM OVERALL HEIGHT, FOR 9 MM HOLE MAZDA, HONDA, NISSAN & TOYOTA</p> <p>UNIT PKG.-25</p>	<p>2539</p>  <p>(96706-H2500) SCREW GROMMET #6 SCREW 6.5 MM HOLE 11.5 MM HEAD DIAMETER 10.5 MM OVERALL LENGTH NISSAN</p> <p>UNIT PKG.-25</p>	<p>2581</p>  <p>(GM-10032838, 1264963) (CHRYSLER-6031869) (AMC-8934-201-602) SCREW GROMMET HOOD HINGE; GRILL AND FLOOR TRIM CLIP</p> <p>UNIT PKG.-25</p>
<p>2681</p>  <p>(W700505S300) (REPLACES-W702438S100) SCREW GROMMET GRILLE, RADIATOR SHIELD #8-10 SCREW 20 MM HD DIAMETER FITS 8 X 10 MM HOLE FORD- CONTOUR & MYSTIQUE</p> <p>UNIT PKG.-50</p>	<p>2683</p>  <p>(W700158S300) SCREW GROMMET-DOOR TRIM 22.5 MM HD DIAMETER 12 MM HOLE 21 MM OVERALL LENGTH FORD-CONTOUR & MYSTIQUE</p> <p>UNIT PKG.-25</p>	<p>2720</p>  <p>(6503108) SCREW GROMMET W/SEALER LUGGAGE COMP. TRUNK TRIM 5/16" HOLE, #8 SCREW CHRYSLER</p> <p>UNIT PKG.-25</p>
<p>2756 (N807994-S) (REPLACES W704740S300) PLASTIC GROMMET GRILLE & SIDE MARKER FOR 10 MM HOLE FORD-'94 & UP</p> <p>UNIT PKG.-25</p> 	<p>2768 (8545-50-786)</p>  <p>SCREW GROMMET 7 MM HOLE; FOR #10 SCREW 13 MM HEAD DIAMETER MAZDA</p> <p>UNIT PKG.-25</p>	<p>2850</p>  <p>(N807706-S) RETAINER- TAIL LAMP AND FRONT FASCIA GROMMET FOR 10 MM HOLE SIZE FORD- '95 & UP</p> <p>UNIT PKG.- 25</p>

NUTS, GROMMETS, RETAINERS

2866

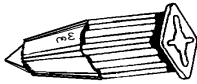

(N804765-S)
SCREW GROMMET
WHEEL OPENING
FOR #8 SCREW
7 MM SQUARE HOLE
FORD PRODUCTS
UNIT PKG.- 50

2947

(W703069-S300)

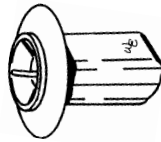

PLASTIC GROMMET
FRONT GRILLE/ FENDER
FOR 8 MM SQUARE HOLE
18 MM FLANGE DIAMETER
4.2 MM (#8) SCREW
FORD FOCUS: 2000-2001
UNIT PKG.-50

2963



(TOYOTA-90189-05012)
(ISUZU-8941340270)
SCREW GROMMET
6 MM X 10 MM HOLE
16 MM WIDE; 12 MM LONG
#6 SCREW
TOYOTA, LEXUS, ISUZU
UNIT PKG.-50

2965

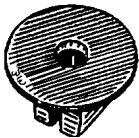

(TOYOTA 90189-06006)
(REPL. NISSAN 01281-00111)
SCREW GROMMET
FOR #10 SCREW
HEAD DIAMETER 17 MM
9 MM SQUARE HOLE
TOYOTA & NISSAN
UNIT PKG.-25

2969



(90107-SX0-003)
BUMPER GROMMET
FOR #10 SCREW
HONDA/ACURA
ACCORD & PRELUDE
1996 & UP
UNIT PKG.-10

2970

(90106-SW3-003)

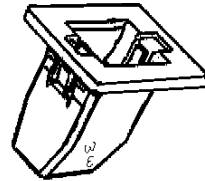

BUMPER GROMMET
HEAD- 18 X 20 MM
20 MM OVERALL HEIGHT
FOR 9 X 11 MM HOLE
HONDA-ACCORD, PRELUDE
& ODYSSEY- 1995 & UP
UNIT PKG.-10

2984

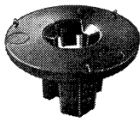

(10262143)
(91517-SEO-0030)
GRILLE PANEL GROMMET
AIR INTAKE
20 MM HEAD
FOR 5 MM STUD
GM & HONDA-'96 & UP
UNIT PKG.-25

3020



(N806334-S)
SCREW GROMMET
FOR #8 (M4.2) SCREW
FOR 6 MM SQUARE HOLE
10 MM SQUARE HEAD
11 MM OVERALL HEIGHT
FORD-'97 & UP
UNIT PKG.-50

3021



(N802376-S)
SCREW GROMMET
FOR #8 (M4.2) SCREW
FOR 6 MM SQUARE HOLE
9.5 MM SQUARE HEAD
7.5 MM OVERALL HEIGHT
FORD
UNIT PKG.-25

3022



(FORD-N811169S, W705550-S300)
(GM-10423331)
RETAINER-PARK &
TURN SIGNAL HOUSING
13 MM HEAD DIAMETER
11 MM OVERALL HEIGHT
FOR 11 MM HOLE
FORD- F250,F550-'99 & UP; GM
UNIT PKG.-50

3025

(4759514AB)





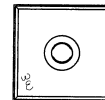
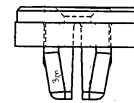

RUBBER GROMMET
FLOOR PAN PLUG & LUGGAGE
AREA CARPET
FOR 9 MM HOLE; 15 MM HD DIAM.
15 MM OVERALL LENGTH
CHRYSLER LH, LHS &
CONCORDE-'97 & UP
UNIT PKG.-50

3026

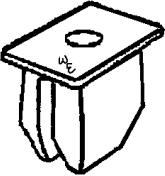
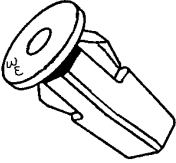
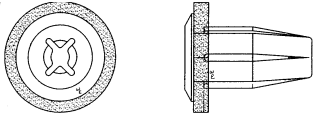

(6505703AA)
PLASTIC SCREW GROMMET
W/SEALING WASHER; TAIL LIGHT
FOR #8 OR #10 SCREW
16 MM SQUARE HEAD
OVERALL HEIGHT 12 MM
FOR 9 MM SQUARE HOLE
JEEP GRAND CHEROKEE 2000 & UP
UNIT PKG.-15

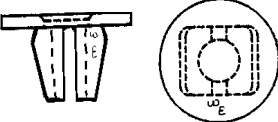
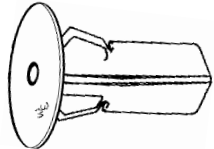
NUTS, GROMMETS, RETAINERS

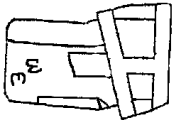
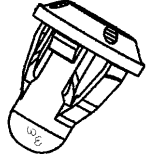
<p>3062</p>  <p>(90189-05105) SCREW GROMMET FRONT FENDER FLARE FOR M4.2 (#8) SCREW 7 X 13 MM HOLE 10 X 15 MM FLANGE TOYOTA RAV 4-'96 & UP UNIT PKG.-15</p>	<p>3063</p>  <p>(90189-06028; GM 94854203) SCREW GROMMET FENDER SHIELD FOR 9 MM SQUARE HOLE FLANGE DIAMETER 16 MM FOR #12 SCREW TOYOTA-'92 & UP-TACOMA, 4-RUNNER, T-100;GM-'85 &UP CHEVY. & PONTIAC UNIT PKG.-15</p>	<p>3072</p>  <p>(90670-SG0-003, 91626-SH3-003) PLASTIC SCREW GROMMET WITH SEALER DOOR PANEL AND SPEAKERS 7 X 7 MM HOLE 4 MM SCREW 17.5 MM OVERALL LENGTH HONDA CRV AND CIVIC '93 & UP UNIT PKG.-15</p>
<p>3073</p>  <p>(90682-SB0-003) PLASTIC SCREW GROMMET GRILLE, BUMPER, FENDER 13 MM SQUARE HEAD 5 MM SCREW 8.5 MM SQUARE HOLE</p> <p>HONDA-'85 & UP UNIT PKG.-25</p>	<p>3092</p>  <p>(NISSAN 01281-00111) (REPLACES TOYOTA 96185-6006) BUMPER COVER SCREW GROMMET 6 MM (#10-14) SCREW FOR 10 MM SQUARE HOLE 16 MM HD DIAMETER 11 MM OVERALL HEIGHT NISSAN, TOYOTA UNIT PKG.-25</p>	<p>3146</p>  <p>(90189-06157) SCREW GROMMET #12 SCREW 8 MM SQUARE HOLE 20 MM HEAD; 22 MM LENGTH TOYOTA</p> <p>UNIT PKG.-15</p>
<p>3168</p>  <p>(01281-01081) PLASTIC SCREW GROMMET 6 MM (#12) SCREW 16 MM FLANGE O.D. 22 MM OVERALL LENGTH FOR 10 MM HOLE NISSAN/INFINITY-1997 & UP</p> <p>UNIT PKG.-15</p>	<p>3169</p>  <p>(01281-01321) PLASTIC SCREW GROMMET 6 MM (#12) SCREW ANGLED HEAD 21.5 MM OVERALL LENGTH FOR 9.5 X 11.5 MM HOLE</p> <p>NISSAN/INFINITY- '96 & UP UNIT PKG.-15</p>	<p>3207</p>  <p>(11561655, 11609862) PLASTIC RETAINER TAIL LAMP ASSEMBLY GROMMET FOR 12 MM HOLE 15 MM HEAD DIAMETER 20 MM OVERALL HEIGHT GM-2005 & UP BUICK, CHEVY, PONTIAC, SATURN</p> <p>UNIT PKG.-5</p>

NUTS, GROMMETS, RETAINERS

3211
(01281-00831)



PLASTIC SCREW GROMMET
FOR 8.5 MM SQUARE HOLE
5 MM (#10) SCREW
16 MM HEAD DIAMETER
21 MM OVERALL HEIGHT
NISSAN-'89 & UP
UNIT PKG.-25

3264
(52535-50060)



BUMPER
COVER SCREW GROMMET
FOR 9 X 12 MM HOLE
18 X 30 MM HEAD
TAKES 12 MM SCREW
TOYOTA CAMRY, HIGHLANDER
LEXUS-2001 & UP
UNIT PKG.- 5

3268
(87756-35000)



PLASTIC GROMMET
DOOR & ROCKER MOULDING
13 MM SQUARE HEAD
OVERALL HEIGHT 12 MM
FOR 5.5 MM (#12) SCREW
HYUNDAI- 1995 & UP
KIA- 2006 & UP
UNIT PKG.- 25

3271
(6035401)

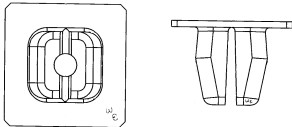

PLASTIC SCREW GROMMET
BUMPER COVER AND
DOOR PANELS
FOR #8 SCREW
9 MM SQUARE HEAD
OVERALL HEIGHT 11 MM
CHRYSLER- 2004 & UP
UNIT PKG.- 25

3281
(90189-06193)

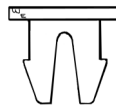

PLASTIC SCREW
GROMMET SPLASH
SHIELD RETAINER
14 X 16 MM HEAD SIZE
(FOR 9 X 11 MM HOLE)
USE WITH 6MM (#12) SCREW
TOYOTA- AVALON, CAMRY &
OTHERS-2002 & UP
UNIT PKG.- 25

3302

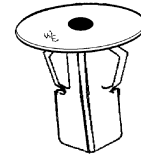

(90189-A0002), (90189-06220)
PLASTIC SCREW GROMMET
FENDER LINER & MUD GUARD
FOR 10 MM SQUARE HOLE
USE WITH #10 SCREW
20 MM HD O.D.; 19 MM O/A HT
TOYOTA/LEXUS-2008 & UP
UNIT PKG.- 25

3333
(90189-04059)
(90189-04229)



PLASTIC SCREW GROMMET
ROCKER MOULDING
FOR 6 X 14.5 MM HOLE
FLANGE 12 X 18 MM
9 MM O/A HEIGHT
FOR #4 OR #6 SCREW
TOYOTA & LEXUS
2006 & UP
UNIT PKG.-25

3334
(90189-06177)



PLASTIC SCREW GROMMET
ROCKER MOULDING
(FOR 9 MM SQ. HOLE; 20MM HD
DIAM.;24MM O/A HEIGHT)
FOR #12 SCREW
TOYOTA-CAMRY,
PRIUS, SCION, & VENZA
'87 & UP
UNIT PKG.-15

3338
(01281-00691)



PLASTIC SCREW GROMMET
WITH SEALER
FOR 8 MM SQ. HOLE
16 MM HEAD DIAM.
22 MM O/A LENGTH
FOR #8 SCREW
NISSAN/INFINITY
'04 & UP
UNIT PKG.-15

3339
(90189-06211)

PLASTIC SCREW GROMMET
ROCKER MLDNG & PILLAR
(FOR 9 MM SQ. HOLE;
17 MM HEAD DIAM.;
10 MM STEM LENGTH(FOR #12 SCREW)
TOYOTA/LEXUS-'07 & UP
UNIT PKG.-25



3354
(90682-SDA-A01)

PLASTIC SCREW GROMMET-BUMPER
COVER; REAR QUARTER PANEL; LINER RETAINER
(FOR 8 MM SQ. HOLE; TAKES 5 MM (#10-#12) SCREW;
14 X 14 MM HEAD; 15 MM O/A HEIGHT)
ACURA & HONDA-'06-UP
UNIT PKG.-15

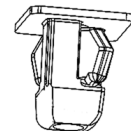

GROMMETS, TUBULAR CLIP, RETAINERS, THREADED INSERTS

3402
(W711031-S300)



**PLASTIC SCREW GROMMET W/SEALER
LICENSE PLATE & TAIL LIGHT ASSEMBLY**
(FOR #12-#14 SCREW; FITS 10 MM SQ. HOLE; 15 MM SQ. HEAD;
26 MM OVERALL LENGTH)
FORD/LINCOLN- VARIOUS MODELS
2006-UP
UNIT PKG.-15

874



TUBULAR CLIPS
3/32" STUD
0.120" HOLE
CHRYSLER

UNIT PKG.-100

875



(CHRYSLER-355891; FORD
-600020)
TUBULAR CLIPS
1/8" STUD; 0.161" HOLE
GM, FORD, CHRYSLER

UNIT PKG.-100

878



TUBULAR CLIPS
3/16" STUD
FOR 7/32" HOLE
UNIVERSAL
UNIT PKG.-100

879

(6000752)
(374684-S32)



TUBULAR CLIPS
3/16" STUD (#10 THREAD)
0.290-0.312" HOLE
CHRYSLER & FORD
UNIT PKG.-100

2245
(4006316)



TUBULAR CLIPS- PLASTIC
1/8" STUD, 3/16" HOLE
UNIVERSAL
UNIT PKG.-100

2982
(06505049AA)



UNTHREADED STUD RETAINER
FENDER MOULDING
FOR 5 MM STUD, 24 MM O.D.
PLATED JEEP- '97 & UP
UNIT PKG.-50

2400
(10056725)



METAL PANEL FASTENER
DOOR PULL STRAP & REAR SPEAKERS
(#8 SCREW), (8 MM SQUARE HOLE)
GM-'88 & UP
UNIT PKG.-25

2879

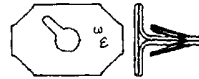

(06036042 AA)
DOOR SILL NUT
FOR #8 SCREW
(9 X 13 MM HEAD)
(10.5 MM OVERALL LENGTH)
CHRYSLER- '99 & UP
UNIT PKG.-25

2304



(5114-1852-899)
PLASTIC INSIGNIA CLIP
BMW
UNIT PKG.-25



THREADED INSERTS-STEEL PLATED



<u>PART #</u>	<u>THREAD SIZE</u>	<u>HOLE SIZE</u>	<u>PANEL RANGE</u>	<u>UPKG.</u>
2154	10-24	9/32"	.03-.165"	25
2155	1/4-20	3/8"	.03-.165"	25
2156	5/16-18	1/2"	.03-.165"	10
5974	4 MM	6.75 MM	0.5-2.0 MM	25
3149	5 MM	7.6 MM	0.5-3.3 MM	25
5942	6 MM	10.0MM	0.7-4.2 MM	15
5943	8 MM	13.5MM	0.7-3.8 MM	10
5944	10 MM	13.5MM	0.7-3.8 MM	10

THREADED INSERTS- HEXAGONAL HOLE STEEL, PLATED













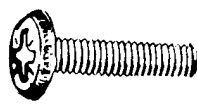

THREAD

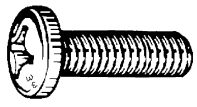

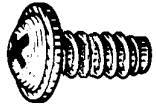

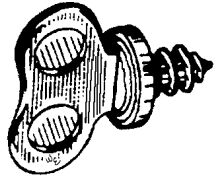
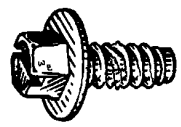
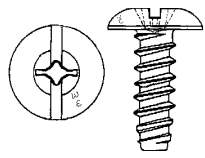

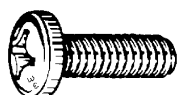
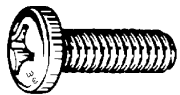

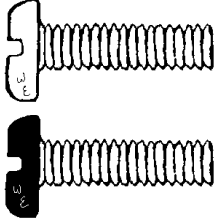

<u>PANEL PART #</u>	<u>SIZE</u>	<u>RANGE</u>
2903	1/4-20	.03-.165" (For 3/8" Hole; 1/2" Hd Diam.)
3300	4 MM	2.0-3.3 MM (for 6.35 MM hole; 10 MM Hd Diam.)
3085	5 MM	0.5-3.3 MM (for 7 MM hole; 10 MM Hd Diam.)
2904	6 MM	0.7-4.2 MM (for 9.5 MM hole; 13 MM Hd Diam.)

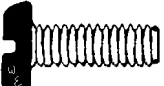
EACH UNIT PKG.-15

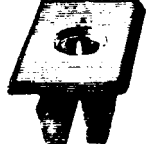
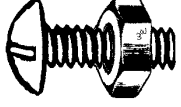
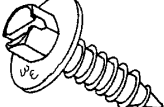

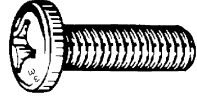

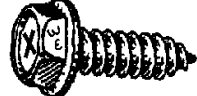

LICENSE PLATES SCREWS AND BOLTS

<p>537 </p> <p>#14 X 3/4" SLOTTED PAN HEAD SCREW-ZINC PLATED (FOR LICENSE PLATES) UNIT PKG.-100</p>	<p>2326 </p> <p>#14 X 5/8" SPECIAL LICENSE PLATE SCREW-SLOTTED ROUND WASHER HEAD (9/16")-BLUNT POINT FOR USE WITH PLASTIC LICENSE PLATE NUTS (W&E #S 818,826)-ZINC UNIT PKG.-100</p>	<p>2547 </p> <p>#14 X 3/4" SLOTTED TRUSS HEAD SCREW-ZINC PLATED (FOR LICENSE PLATES) UNIT PKG.-100</p>
<p>2203 </p> <p>#14 X 3/4" SLOTTED HEX WASHER HEAD TAPPING SCREW TYPE-AB, ZINC PLATED (FOR LICENSE PLATES) USE WITH #818, 826 UNIT PKG.-50</p>	<p>5959 </p> <p>6 X 20 MM PHILLIPS PAN HEAD LICENSE PLATE BOLT- FORD ZINC/YELLOW PLATED UNIT PKG.-50</p>	<p>2704 </p> <p>LICENSE PLATE SCREW IMPORTS & UNIVERSAL #10 X 5/8" PHILLIPS TRUSS HEAD SHEET METAL SCREW BLACK UNIT PKG.-100</p>
<p>3329 </p> <p>6-1.0 X 20 MM PHILLIPS PAN HEAD MACHINE SCREW (LIC. PLATE SCREW) STAINLESS STEEL UNIT PKG.-25</p>		
<p>5960 </p> <p>6 X 16 MM SLOTTED WASHER PAN HEAD LICENSE PLATE BOLT ZINC PLATED UNIT PKG.-50</p>	<p>2779 </p> <p>6.3-1.81 X 16 MM(#14X5/8") PHILLIPS WASHER HEAD SHEET METAL SCREW (13.5 MM WASHER DIAM.) LICENSE PLATE-JAPANESE CARS ZINC/YELLOW UNIT PKG.-50</p>	<p>2663 </p> <p>LICENSE PLATE SCREW #14 X 3/4" SLOTTED TRUSS HEAD SHEET METAL SCREW-A; ZINC/BLACK UNIT PKG.-100</p>
<p>2444 </p> <p>DEALER LICENSE PLATE THUMB SCREW #14 X 1/2" (1-1/4" OVERALL LENGTH) ZINC DIECAST UNIT PKG.-15</p>	<p>2446 </p> <p>(N 800369-S2) LICENSE PLATE SCREW 1/4"-14 X 5/8" SLOTTED HEX WASHER HEAD-5/16" HEX 5/8" WASHER DIAM. FORD PRODUCTS BLACK UNIT PKG.-50</p>	<p>2895 (9423101) </p> <p>6.3-1.81 X 16 MM COMBO HEAD (PHILLIPS/SLOTTED) SHEET METAL SCREW-B ZINC PHOSPHATE PLATED (500 HR SALT SPRAY) GM UNIT PKG.-50</p>
<p>3147 (REPL. 16502342) </p> <p>6.3-1.81 X 30 MM, (#14X1-3/16") SLOTTED TRUSS HEAD LICENSE PLATE SCREW GM-S&T TRUCKS & UNIVERSAL BLACK(500 HR.SALT SPRAY) UNIT PKG.-50</p>	<p>3221 </p> <p>6-1.0 X 16 MM PHILLIPS PAN HEAD MACHINE SCREW (LIC. PLATE SCREW)-DIN 7985 ZINC PLATED UNIT PKG.-50</p>	<p>3243 </p> <p>6-1.0 X 16 MM PHILLIPS PAN HEAD LICENSE PLATE SCREW STAINLESS STEEL UNIT PKG.-25</p>

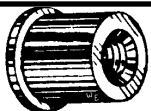
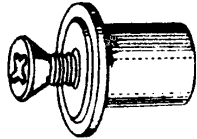

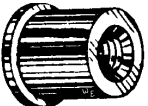

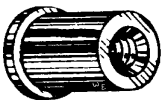
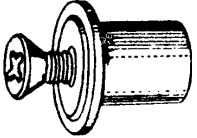
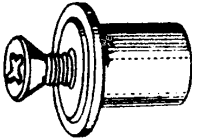
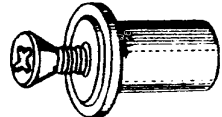
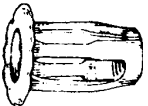
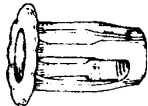

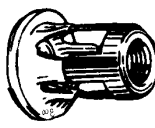



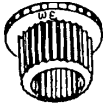

LICENSE PLATES SCREWS, BOLTS & NUTS

<p>2661 (NATURAL) 2662 (BLACK)</p>  <p style="text-align: center;">NYLON LICENSE PLATE SCREW 6 X 20 MM SLOTTED PAN HEAD (12 MM HEAD DIAMETER) EACH UNIT PKG.-100</p>	<p style="text-align: center;">BLACK NYLON LICENSE PLATE SCREW SLOTTED PAN HEAD (12 MM HEAD DIAM.)</p> <p>3180-6 X 12 MM </p> <p>3181-6 X 16 MM </p> <p style="text-align: center;">EACH UNIT PKG.-100</p>	<p>2772 (USE WITH W&E #2661) NATURAL </p> <p>2773 (USE WITH W&E #2662, #3180, #3181) BLACK</p> <p style="text-align: center;">6 MM NYLON HEX NUT (10 MM HEX) EACH UNIT PKG.-100</p>	
<p>818 (3907444) (379046-S)</p>  <p style="text-align: center;">LICENSE PLATE NUT UNIVERSAL (USE #14 SCREWS) (W&E 537, 2203, 2326, 2547) UNIT PKG.-50</p>	<p>826</p>  <p style="text-align: center;">(1196781), (4755299) GRILLE TO RADIATOR NUT LICENSE PLATE NUT HEADLAMP ADJUSTING NUT #14 SCREW-GM, FORD UNIT PKG.-50</p>	<p>963</p>  <p style="text-align: center;">1/4-20 X 5/8" SLOTTED TRUSS HEAD SCREW WITH HEX NUT-ZINC UNIT PKG.-100</p>	
<p>3084</p>  <p style="text-align: center;">6.3-1.81 X 16 MM (#14 x 5/8") SLOTTED INDENTED HEX WASHER HEAD LICENSE PLATE SCREW-AB 8 MM (5/16") HEX, 16 MM (5/8") WASHER DIAM. FORD BLACK (500 HR. SALT SPRAY) UNIT PKG.-50</p>	<p>3090</p>  <p style="text-align: center;">(TOYOTA-93904-46320) (HONDA-91500-SM4-999AA) 6-1.81 X 20 MM PHILLIPS HEX WASHER HEAD LIC. PLATE SCREW (#14 X 3/4"; 10 MM HEX 13 MM WASHER) ZINC/YELLOW UNIT PKG.-50</p>	<p>3183</p>  <p style="text-align: center;">#14 X 3/4" PHILLIPS TRUSS HEAD SHEET METAL SCREW FOR LICENSE PLATES ZINC PLATED UNIT PKG.-100</p>	
SPECIALIZED MOUNTING HARDWARE			<p>3376</p>  <p style="text-align: center;">6-1.0 X 25 MM PHILLIPS PAN HEAD MACHINE SCREW (DIN 7985) GENERAL & LICENSE PLATE USE STAINLESS STEEL UNIT PKG.-25</p>
<p>2525</p>  <p style="text-align: center;">6-1.0 X 26 MM STAINLESS STEEL PHILLIPS OVAL HD MACHINE SCREW (#10 HD) FOR MIRROR & ROOF RACK INSTALLATION UNIT PKG.-25</p>	<p>2527</p>  <p style="text-align: center;">1/4"-20 X 1" STAINLESS STEEL PHILLIPS OVAL HD MACHINE SCREW (#10 HD) FOR MIRROR & ROOF RACK INSTALLATION UNIT PKG.-25</p>	<p>2836</p>  <p style="text-align: center;">5-0.8 X 26 MM STAINLESS STEEL PHILLIPS OVAL HEAD MACHINE SCREW FOR MIRROR & ROOF RACK INSTALLATION UNIT PKG.-25</p>	<p>3385</p>  <p style="text-align: center;">#14 X 3/4" (6.3X 20 MM) PHILLIPS HEX WASHER HD SCREW AB-HEAVY ZINC PLATED (MIN.350 HRS SALT SPRAY TOLERANCE) LICENSE PLATE SCREW & GENERAL USE UNIT PKG.-50</p>

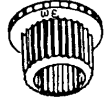
SPECIALIZED MOUNTING HARDWARE

<p>2906 (20130258)</p>  <p>"WELL NUT" FOR ATTACHING ROOF/LUGGAGE RACKS 6 MM SCREW SIZE, 13 MM HOLE 20 MM FLANGE DIAMETER (LARGER FLANGE THAN W&E #2524) UNIT PKG.-10</p>	<p>2907</p>  <p>ROOF/LUGGAGE RACK ASSEMBLY 6 MM WELL NUT WITH 20 MM FLANGE, PLATED MACHINE SCREW AND FLAT WASHER UNIT PKG.-10</p>	
<p>2272</p>  <p>(OE-6027941) 1/4"-20 X 7/8" PHILLIPS OVAL HEAD MACHINE SCREW (TRIM HEAD) DECK LID LUGGAGE RACK AND SIDE VIEW MIRROR UNIT PKG.-25</p>	<p>2285</p>  <p>(GM-342271) "WELL NUT" 1/4"-20 SCREW SIZE; 1/2" HOLE FOR ATTACHING ROOF RACK OR MIRRORS NEOPRENE WITH CAPTIVE BRASS NUT UNIT PKG.-10</p>	<p>2524</p>  <p>(GM-15505451, AMC-8934201293) 6 MM SCREW SIZE; 13 MM HOLE 16 MM HEAD DIAMETER "WELL NUT" -FOR ATTACHING ROOF RACK OR MIRRORS NEOPRENE WITH CAPTIVE BRASS NUT UNIT PKG.-10</p>
<p>2810</p>  <p>(REPLACES-10137292, 22520368) (140050597) "WELL NUT" 5 MM SCREW SIZE; 14.3 MM HEAD, FOR 9.5 MM HOLE; NEOPRENE WITH CAPTIVE BRASS NUT FOR ATTACHING ROOF RACK AND LUGGAGE MOUNT UNIT PKG.-10</p>	<p>2324</p>  <p>ROOF RACK/ LUGGAGE MOUNT ASSEMBLY; (1/4"-20 WELL NUT STAINLESS STEEL MACHINE SCREW, FLAT WASHER) UNIT PKG.- 10</p>	<p>2526</p>  <p>ROOF RACK/ LUGGAGE MOUNT ASSEMBLY; (6 MM WELL NUT STAINLESS STEEL MACHINE SCREW, FLAT WASHER) UNIT PKG.- 10</p>
<p>2837</p>  <p>ROOF RACK/ LUGGAGE MOUNT ASSEMBLY; 5 MM WELL NUT, STAINLESS STEEL MACHINE SCREW, FLAT WASHER) UNIT PKG.- 10</p>	<p>2183</p>  <p>(14005953), (367292) 1/4"-20 JACK NUT LICENSE PLATE & MIRROR MOUNTING UNIVERSAL UNIT PKG.-25</p>	<p>2522</p>  <p>(5970995), (10014363) 6 MM JACK NUT LICENSE PLATE & MIRROR MOUNTING UNIVERSAL UNIT PKG.-25</p>
<p>2161</p>  <p>1/4"-20 X 1" HEX WASHER HEAD MACHINE SCREW (USE WITH W&E #2183) ZINC PLATED UNIT PKG.-50</p>	<p>2432 (367292) (6031438)</p>  <p>1/4"-20 COATED JACK NUT ROOF RACK MOUNT GM, CHRYSLER & UNIVERSAL UNIT PKG.-10</p>	

DOOR HINGE BUSHINGS AND CLIPS

<p>2281</p>  <p>(9721917) DOOR HINGE BUSHING (.344"-I.D.), (.421"-O.D.) (.296" OVERALL HEIGHT) (USE WITH #2357)-GM BRONZE UNIT PKG.-15</p>	<p>2282</p>  <p>(9716926), (20345137) DOOR HINGE BUSHING (.341"-I.D.) (.490"-O.D.) (.358" OVERALL HEIGHT) GM-(A,B,F,J,BODIES) TRUCKS & VANS BRONZE UNIT PKG.-15</p>	<p>2283 (9822198)</p>  <p>DOOR HINGE BUSHING (.382"-I.D.) (.504"-O.D.) (.460" OVERALL HEIGHT) GM-BRONZE UNIT PKG.-15</p>
<p>2284 (20429500)</p>  <p>DOOR HINGE BUSHING (.344"-I.D.) (.494"-O.D.) (.360" OVERALL HEIGHT) GM(A,B,F,J BODIES) TRUCKS & VANS (USE WITH #2358 OR #2944) BRONZE UNIT PKG.-15</p>	<p>2327</p>  <p>(D90Z-6522841A) (D20B-6522841AA) DOOR HINGE BUSHING (.346"-I.D.) (.477"-O.D.) (.293" OVERALL HEIGHT)-BRONZE FORD- '79 & UP (USE WITH #2943) UNIT PKG.-15</p>	<p>2457 (2486468)</p>  <p>DOOR HINGE BUSHING (.346"-I.D.) (.419"-O.D.) (.444" OVERALL HEIGHT) CHRYSLER VANS BRONZE UNIT PKG.-15</p>
<p>3151</p> <p style="text-align: center;">DOOR HINGE BUSHING (.494" O.D.) (.376" I.D.), (.250" OVERALL HEIGHT) CHRYSLER (DODGE, PLYMOUTH) 1984-1995 BRONZE (USE WITH W&E #2635) UNIT PKG.-15</p> 		<p>2740</p>  <p>(15562609, 15964972), (16632192) DOOR HINGE BUSHING-UPPER (.391"-I.D.) (.532"-O.D.) (.359" OVERALL HEIGHT) GM TRUCKS- '88 & UP (USE WITH W&E #2714 OR #2896) BRONZE UNIT PKG.-15</p>
<p>2637 (4336115)</p>  <p>DOOR HINGE BUSHING (.252"-I.D.), (.371"-O.D.) (.391" OVERALL HEIGHT)-BRONZE CHRYSLER-'86 & UP UNIT PKG.-15</p>	<p>2639 (80410-01G00)</p>  <p>DOOR HINGE BUSHING (8 MM-I.D.), (10 MM-O.D.) (10.5 MM OVERALL HEIGHT)-BRONZE NISSAN TRUCKS-'85 & UP (USE WITH W&E #2638) UNIT PKG.-6</p>	<p>2741</p>  <p>(12338074, 15964971) (15691493, 16632193) DOOR HINGE BUSHING-LOWER (.344"-I.D.) (.484"-O.D.) (.359" OVERALL HEIGHT) GM TRUCKS-'88 & UP (USE WITH W&E #2714 OR #2986) BRONZE UNIT PKG.-15</p>
<p>3160</p>  <p>(GM-15994486) DOOR HINGE BUSHING (.404"-I.D.;.492"-O.D.) (.356" OVERALL HEIGHT) (USE WITH #3159; IN KIT #3164) STAMPED STEEL UNIT PKG.-15</p>	<p>3154</p>  <p>DOOR HINGE BUSHING (.320"-I.D.;.408"-O.D.) (.219" OVERALL HEIGHT) JEEP (CHEROKEE) 1984-1999 (USE WITH #3153;-IN KIT #3163) STAMPED STEEL UNIT PKG.-15</p>	

DOOR HINGE PINS

DRP-1

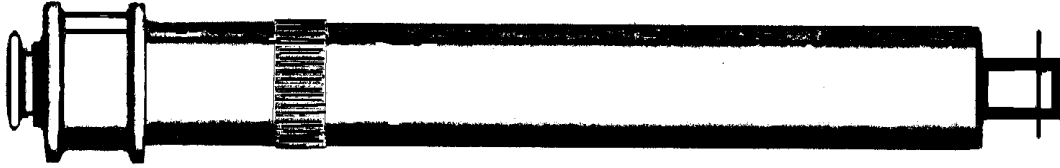

DOOR ROLLER PIN ASSEMBLY- GM CK 1,2,3 TRUCKS- '88 & UP (NOT AVAILABLE THROUGH OEM)
(MAJOR DIAMETER-9/16"; OVERALL LENGTH- 5-1/2")
UNIT PKG.-1

2714



(OE 15591860, 15691595, 15967691, 15685040)
DOOR HINGE PIN(STAINLESS STEEL)-11/32" X 5-1/4"; SHOULDER DIAM. 3/8"
GM TRUCKS- '88 & UP (USE WITH #2740 AND #2741)
UNIT PKG.-4

2357



(OE 6271989, 20046147)
DOOR HINGE PIN-11/32" X 4-1/8"; HEAD DIAMETER 9/16"
GM CARS & TRUCKS (USE WITH #2281)
UNIT PKG.-8

2358

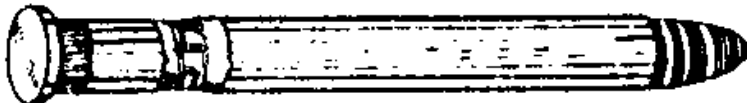

(OE 20043351)
DOOR HINGE PIN-11/32" X 4"
GM CARS-'81-'84 & UP (CITATION, T-100, CHEVETTE) (USE WITH #2284)
UNIT PKG.-4

2359



(OE 6500361)
DOOR HINGE PIN-1/4" X 2-5/32"
CHRYSLER-'80 & UP
UNIT PKG.-12

2360



(OE 6028993, 6032975)
DOOR HINGE PIN-1/4" X 2-5/8"
DODGE & PLYMOUTH VANS-'70 & UP
UNIT PKG.-8

2635



(OE 4280727, 5505125)
DOOR HINGE PIN-3/8" X 3-1/8" CHRYSLER-'84 & UP
UNIT PKG.-6

DOOR HINGE PINS

2638
(OE 80406-V5002)

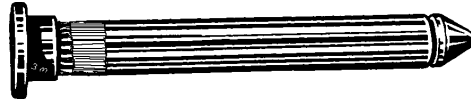

DOOR HINGE PIN-8 X 72 MM
(INCLUDES 1/4" "E" CLIP)
USE WITH W&E #2639
NISSAN TRUCKS- '85 & UP
UNIT PKG.-5

2896



(OE 15653790), (15646148)
DOOR HINGE PIN-11/32" X 4-1/8"
HEAD DIAMETER 1/2"(SHOULDER DIAM.-3/8")
ZINC/YELLOW
(USE WITH BUSHINGS-#2740 AND #2741), (USE WITH W&E #2753 OR #2647)
GM S&T TRUCKS-'94 & UP
UNIT PKG.-4

2943
(E8UZ1522840)



DOOR HINGE PIN
11/32" O.D., 3-1/2" LONG (USE WITH W&E #2327 & #2648)
FORD TRUCKS-'85 & UP- ZINC/YELLOW PLATED
UNIT PKG.-5

2944

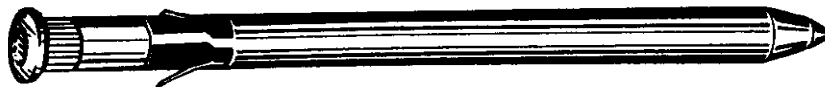

(12338015, 14066728)
DOOR HINGE PIN- 11/32" O.D., 4-1/8" LONG
USE WITH W&E # 2284
GM, ASTRO SAFARI VANS, S-10 TRUCKS-'82 & UP- ZINC/YELLOW PLATED
UNIT PKG.-5

3152

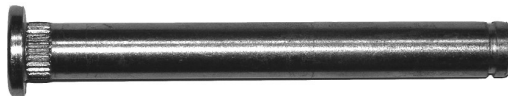

DOOR HINGE PIN
11/32" X 2-3/4" WITH 9/16" HEAD DIAMETER
FORD- VARIOUS CARS, TRUCKS, VANS-1994 & UP
USE WITH W&E # 2741 & #2648 (IN KIT- W&E # 3162)
UNIT PKG.-4

DOOR HINGE PINS, KITS, CLIPS

3153



DOOR HINGE PIN
 5/16" X 2-35/64"
 7/16" HEAD DIAMETER
 JEEP (CHEROKEE)-1984-1999
 (USE WITH #3154, #3158, #2647)
 (IN KIT #3163)
 UNIT PKG.-4

3159



DOOR HINGE PIN
 3/8" X 3"
 21/32" HEAD DIAMETER-ZINC
 GM FULL SIZE VANS
 (USE WITH W&E #3160, IN KIT #3164)
 UNIT PKG.-4

3161



(D9ZZ-6643030-AA)
DOOR HINGE PIN
 11/32" X 3-15/32", 9/16" HEAD DIAMETER-ZINC
 FORD-MUSTANG, TEMPO, TOPAZ, CAPRI-'79-'94
 (USE WITH W&E #2327; IN KIT #3165)
 UNIT PKG.-5

3163

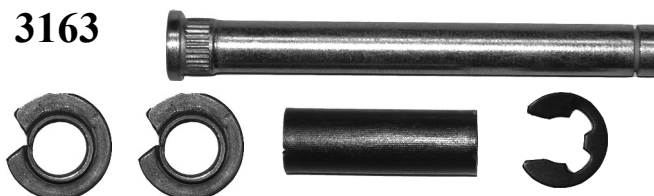

DOOR HINGE PIN & BUSHING KIT
 JEEP (CHEROKEE)-1984-1999
 (CONTAINS 2 EA.#3153, 4 EA.-#3154
 2 EA.-#3158 AND 2 EA.-#2647)
 UNIT PKG.-1 SET

3162



DOOR HINGE PIN & BUSHING KIT
 FORD- VARIOUS CARS, TRUCKS, VANS-1994 & UP
 (CONTAINS 2 EA.-#3152, 4 EA.-#2741 and 2 EA.#2648)
 UNIT PKG.-1 SET

3165



HINGE PIN AND BUSHING SET
 FORD-MUSTANG, TEMPO, TOPAZ, CAPRI
 1979-1994
 (CONTAINS 2 EA.-W&E #3161 & 4 EA.-W&E #2327)
 UNIT PKG.-1 SET

3158

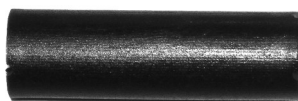

DOOR HINGE PIN SLEEVE
 JEEP-CHEROKEE
 1984-1999
 (USE WITH #3153 IN KIT #3163)
 UNIT PKG.-10

2600

(OE 4280729)



HINGE PIN CLIP
 (I.D.-8.3 MM,
 OVERALL HEIGHT-
 9.85 MM)
 CHRYSLER- '80 & UP
 ZINC DICHROMATE
 UNIT PKG.-25

2753

(15562610)

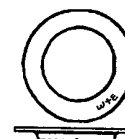

DOOR HINGE PIN CLIP
 GM C-K TRUCKS-'88 & UP
 (USE WITH W&E #2714)
 STAINLESS STEEL
 UNIT PKG.-50

DOOR HINGE PINS AND BUSHING SETS

2949



FORD TRUCKS DOOR HINGE PIN AND BUSHING SET
 (CONSISTS OF TWO EACH HINGE PINS, FOUR BUSHINGS AND TWO "E" CLIPS)
 (W&E #S 2943, 2327 AND 2648)
UNIT PKG.-1 SET

2901

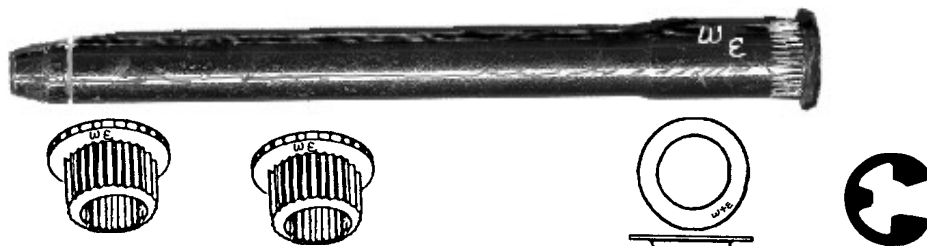

GM S&T TRUCKS - HINGE PIN, BUSHING AND RETAINER SET
 (CONSISTS OF TWO EACH- UPPER & LOWER BUSHINGS, RETAINERS, "E" CLIPS AND HINGE PINS)
 (W&E #S 2896,2740,2741, 2753 & 2648)
UNIT PKG.-1 SET

2950



GM ASTRO SAFARI VAN AND S-10 TRUCK DOOR HINGE PIN AND BUSHING SET
 (CONSISTS OF TWO EACH HINGE PINS AND FOUR BUSHINGS)
 (W&E #S 2944 AND 2284)
UNIT PKG.-1 SET

2994



GM FULL SIZE VANS '78-'96 DOOR HINGE PIN & BUSHING SET
 (CONSISTS OF TWO EACH HINGE PINS & RETAINERS AND FOUR EACH BUSHINGS)
 (W&E #S 2357, 2753, 2281)
UNIT PKG.-1 SET

3148

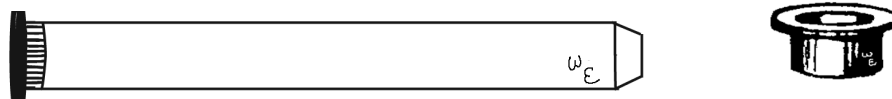

DOOR PIN AND BUSHING KIT
 (PIN-OE 55076192; BUSHING-OE 55074591)
FRONT DOOR
 1994-1998 JEEP GRAND CHEROKEE
 (CONTAINS TWO PINS AND FOUR BUSHINGS)
UNIT PKG.-1 SET

DOOR HINGE PINS AND BUSHING SETS

2748

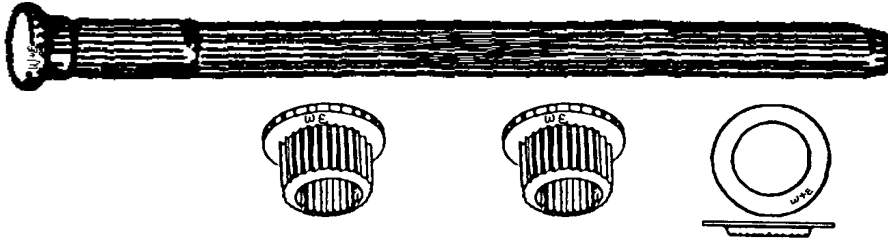

**GM FULL SIZE TRUCKS-HINGE PIN, BUSHING,
AND RETAINER SET-'88-'98**
(CONSISTS OF TWO OF EACH PART- UPPER, LOWER BUSHINGS, RETAINERS AND HINGE PINS)
(CONTAINS W&E PART #S: #2714, #2740, #2741, #2753)
UNIT PKG.-1 SET

2995

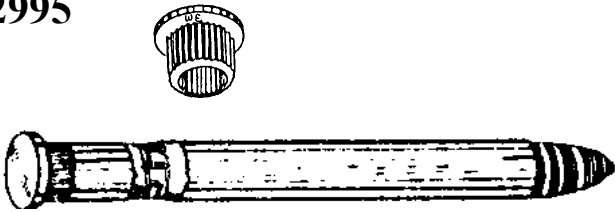

OLDS CUTLASS CIERRA -'82-'96
HINGE PIN AND BUSHING SET
(CONSISTS OF TWO EACH HINGE PINS AND FOUR
EACH BUSHINGS) (W&E #S 2358 AND 2284)

UNIT PKG.-1 SET

3164

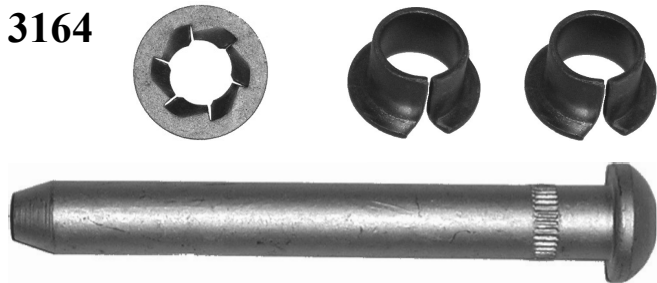

DOOR PIN AND BUSHING KIT
GM FULL SIZE VANS, HINGED SIDE DOOR
CHEVY EXPRESS/GMC SAVANA -1996-2006
(CONTAINS TWO PINS, FOUR BUSHINGS
AND TWO RETAINERS)
UNIT PKG.-1 SET

3070

**DOOR HINGE
REPAIR
KIT**

(THREADED PINS &
NYLOK NUTS)



GM C & K TRUCKS
1999 & UP
CONSISTS OF TWO EACH LONG AND SHORT
PINS, FOUR BUSHINGS,
TWO WASHERS
AND FOUR NUTS
(HINGE NOT INCLUDED)
KIT CONTAINS PARTS TO COMPLETE
ONE DOOR (UPPER AND LOWER HINGE)

UNIT PKG.-1 SET

3071 DODGE HINGE PIN & BUSHING KIT

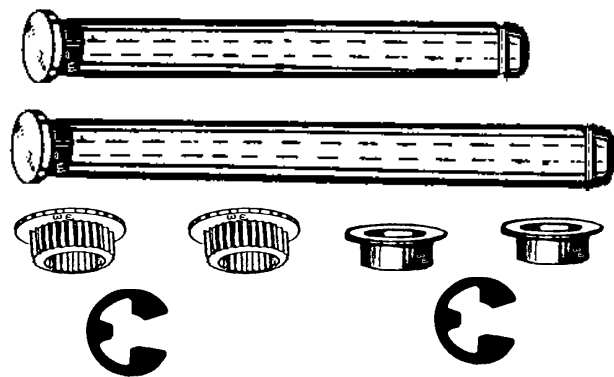

(CONSISTS OF TWO PINS, FOUR BUSHINGS
AND TWO "E" CLIPS)
DODGE RAM PICK UP-'97 & UP
DODGE DAKOTA-'97 & UP

UNIT PKG.-1 SET

**WASHERS, FINISHING, TOOTHED, FLUSH
MACHINE SCREWS, COTTER PINS**

**COUNTERSUNK FINISHING WASHERS
STEEL**



<u>PART #</u>	<u>SCREW SIZE</u>	<u>PLATED</u>
1036	#6	NICKEL
1037	#8	NICKEL
1038	#10	NICKEL
1039	#12	NICKEL
2515	#6	BLACK
2518	#12	BLACK

EACH UNIT PKG.-100

**FLUSH TYPE
FINISHING WASHERS
(BRASS, NICKEL PLATED)**



<u>PART #</u>	<u>SCREW SIZE</u>
1042	#6
1044	#10

EACH UNIT PKG.-100

**STEEL COTTER PINS
ZINC PLATED**



<u>PART #</u>	<u>SIZE</u>	<u>UPKG.</u>
2167	1/16" x 1"	200
2168	3/32" x 1"	200
2793	3/32" x 2"	100
2169	1/8" x 1-1/2"	200
2170	1/8" x 2"	200
2171	5/32" x 1-1/2"	100
2172	5/32" x 2"	100

**TOOTHED LOCKWASHERS
EXTERNAL TEETH**



<u>PART #</u>	<u>SCREW SIZE</u>
1061	#6
1062	#8
1063	#10
1064	#12
1065	#14

EACH UNIT PKG.-100

MACHINE SCREWS PLATED



<u>PART #</u>	<u>DESCRIPTION</u>	<u>UPKG.</u>
1411	8-32 X 1/2" SLOTTED ROUND HD	100
1415	10-24 X 1/2" SLOTTED ROUND HD	100
1420	10-32 X 1/2" SLOTTED ROUND HD	100
2158	10-24 X 3/4" PHILLIPS OVAL HD	100
2159	1/4"-20 X 3/4" PHILLIPS OVAL HD	50
2160	1/4"-20 X 1" PHILLIPS OVAL HD	50

**TOOTHED LOCKWASHERS
INTERNAL TEETH**



<u>PART #</u>	<u>SCREW SIZE</u>
1071	#6
1072	#8
1073	#10
1074	#12
1075	#14
1077	3/8"
1078	7/16"
1079	1/2"

EACH UNIT PKG.-100

SPECIAL PLASTIC PARTS

810

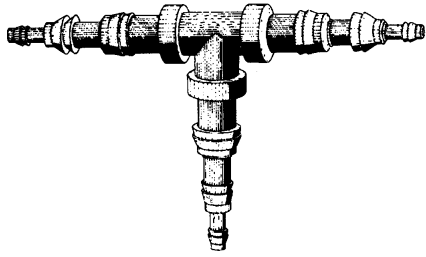

(PICTURE SMALLER THAN ACTUAL SIZE)
PLASTIC UNIVERSAL BREAK-OFF TEE
 FOR 1/8", 1/4" AND 3/8" TUBING
 UNIT PKG.-5

2146



UNIVERSAL TUBING CONNECTOR
 (BREAK OFF TYPE)
 1/8" TO 1/4" TO 3/8"
 GOES FROM ONE SIZE TO ANOTHER
 UNIT PKG.-10

2546



(OE-25512081, 386132-S, 386132)
WIRING/TUBING CLIP
 1/4" DIAMETER TUBING
 1/4" HOLE SIZE
 GM, FORD, CHRYSLER
 & UNIVERSAL
 UNIT PKG.-25

2289

(OE-8911497)

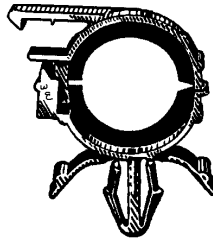

CONVOLUTED
WIRING HARNESS CLIP
 (.413" DIAMETER)
 ALL GM CARS
 UNIT PKG.-25

2219

(OE-8911472)



CONVOLUTED
WIRING HARNESS CLIP
 (.500" DIAMETER)-ALL GM CARS
 UNIT PKG.-25

2290

(OE-8917320)
 (3816659)

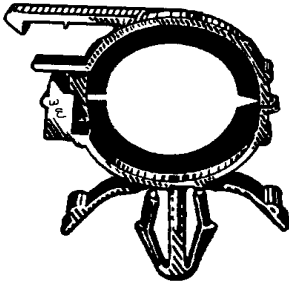

CONVOLUTED
WIRING HARNESS CLIP
 (.750" DIAMETER)
 GM & UNIVERSAL
 UNIT PKG.-25

2854

(12040984)

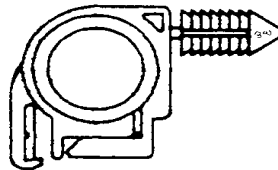

CONVOLUTED WIRING
HARNESS CLIP-3/8" DIAM.
 (USE WITH W & E #2553)
 (1/4" HOLE)
 GM & UNIVERSAL
 UNIT PKG.-15

2855

(1204098)

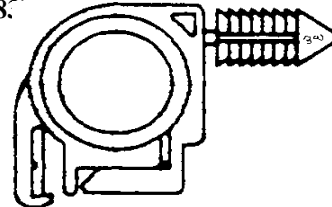

CONVOLUTED WIRING
HARNESS CLIP-1/2" DIAM.
 (USE WITH W & E #2555)
 (1/4" HOLE)
 GM & UNIVERSAL
 UNIT PKG.-15

2129

(OE-6015930)

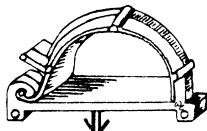

(PICTURE NOT ACTUAL SIZE)
SELF LOCKING & UNLOCKING UNIVERSAL
PLASTIC PUSH-IN WIRE & HOSE RETAINER
 UNIT PKG.-10



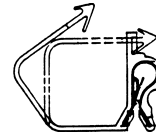

2422

(OE-N805940S)

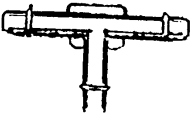

(PICTURE NOT ACTUAL SIZE)
WIRING CLIP- ANTILOCK BRAKES
 '89 T-BIRD, COUGAR & UNIVERSAL
 UNIT PKG.-10

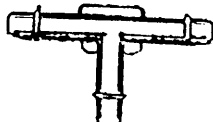
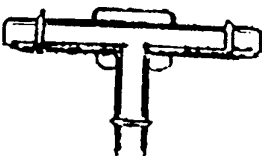
SPECIAL PLASTIC PARTS

<p>2426 </p> <p>(357020, 6272766, 22508050) (373846-S, 3671410, 3673945) 3/16" X 3/16" X 3/16" THREE WAY VACUUM TEE GM, FORD, CHRYSLER & UNIVERSAL UNIT PKG.-10</p>	<p>2427 </p> <p>(560625, 22508051, 383003) (389138, 4104998) 3/16" X 3/16" CONNECTOR GM, FORD, CHRYSLER & UNIVERSAL UNIT PKG.-10</p>	<p>2430 </p> <p>(14017705, 3895904, 3751212) 1/8" X 1/8" X 1/8" THREE WAY VACUUM TEE GM, FORD, CHRYSLER & UNIVERSAL UNIT PKG.-10</p>															
<p>2431 </p> <p>1/4" X 1/4" X 1/4" THREE WAY VACUUM TEE GM & UNIVERSAL UNIT PKG.-10</p>	<p>3189 </p> <p>1/8" STRAIGHT VACUUM CONNECTOR UNIT PKG.-10</p>	<p>VACUUM CAPS GM, FORD, CHRYSLER AND UNIVERSAL </p> <table style="width: 100%; border-collapse: collapse;"> <thead> <tr> <th style="text-align: left;"><u>PART #</u> <u>UPKG.</u></th> <th style="text-align: left;"><u>SIZE</u></th> <th></th> </tr> </thead> <tbody> <tr> <td>2988</td> <td>1/8"</td> <td>25</td> </tr> <tr> <td>2428</td> <td>3/16"</td> <td>15</td> </tr> <tr> <td>(REPLACES-380614-S)</td> <td></td> <td></td> </tr> <tr> <td>2989</td> <td>1/4"</td> <td>25</td> </tr> </tbody> </table>	<u>PART #</u> <u>UPKG.</u>	<u>SIZE</u>		2988	1/8"	25	2428	3/16"	15	(REPLACES-380614-S)			2989	1/4"	25
<u>PART #</u> <u>UPKG.</u>	<u>SIZE</u>																
2988	1/8"	25															
2428	3/16"	15															
(REPLACES-380614-S)																	
2989	1/4"	25															

HOLE PLUGS- FLUSH TYPE
USED FOR PAINTLESS DENT REMOVAL
AND RUSTPROOFING 

<u>PART #</u>	<u>HOLE SIZE</u>	<u>PANEL RANGE</u>	<u>UNIT PKG.</u>
2722	1/4"	.02-.07	100
2723	3/8"	.02-.05	100
2724	1/2"	.03-.08	100
2725	3/4"	.05-.11	100
2806	1"	.03-.08	50
2807	1-1/2"	.02-.08	25

3066 

(E9DB-14A-163CA)
RETAINER-RELAY
FOR 6.3 MM HOLE
HEAD SIZE-10 X 30 MM
FORD

UNIT PKG.-25

HOLE PLUGS-RECESSED HEAD















USED FOR RUSTPROOFING AND PAINTLESS DENT
REPAIR

<u>PART #</u>	<u>HOLE SIZE</u>	<u>PANEL THICKNESS</u>
2147	1/2"	.06-.13"
2702	3/4"	.02-.14"

EACH UNIT PKG.-100

VTC-50
VACUUM TEE AND CAP
ASSORTMENT

 <p>2426</p>  <p>(357020) (6272766) (22508050) (373846-S) (3671410) (3673945) 3/16" X 3/16" X 3/16" THREE WAY VACUUM TEE GM, FORD, CHRYSLER & UNIVERSAL</p>	 <p>2427</p>  <p>(560625) (22508051) (383003) (389138) (4104998) 3/16" X 3/16" CONNECTOR GM, FORD, CHRYSLER & UNIVERSAL</p>	 <p>2430</p>  <p>(14017705) (3895904) (3751212) 1/8" X 1/8" X 1/8" THREE WAY VACUUM TEE GM, FORD, CHRYSLER & UNIVERSAL</p>	 <p>2431</p>  <p>1/4" X 1/4" X 1/4" THREE WAY VACUUM TEE GM & UNIVERSAL</p>	 <p>2428</p>  <p>3/16" VACUUM CAP GM, FORD, CHRYSLER AND UNIVERSAL</p>	 <p>2988</p>  <p>1/8" VACUUM CAP GM, FORD, CHRYSLER AND UNIVERSAL</p> <p>2989</p>  <p>1/4" VACUUM CAP GM, FORD, CHRYSLER AND UNIVERSAL</p>
---	---	--	---	--	--

UNIT PKG.-1

PLASTIC CABLE STRAPS

988



(1189106), (3750535), (6015149)
PLASTIC CABLE STRAP-3-5/8" LONG
GM & CHRYSLER
UNIT PKG.-100

989



WIRING STRAP
UNIVERSAL
2-3/4" LONG; FOR 1/4" HOLE
UNIT PKG.-50

990



WIRING STRAP
UNIVERSAL
2-3/4" LONG; FOR 1/4" HOLE
UNIT PKG.-50

991



REUSABLE CABLE STRAP-HEAVY DUTY PLASTIC -9" LONG
UNIT PKG.-25

2120

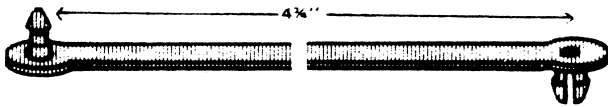

WIRING STRAP-4-3/4" LONG
FOR 1/4" HOLE; AMC & UNIVERSAL
UNIT PKG.-25

2497



(90672-SA-0-0030); (9928-91-053353)
REUSABLE CABLE STRAP
(140 MM LONG, 7 MM HOLE)
HONDA, MAZDA
UNIT PKG.-20

3323

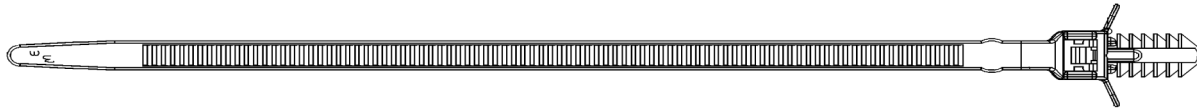

(OE NOT AVAILABLE)
PUSH MOUNT CABLE TIE - BLACK
FOR 6.3 MM HOLE (1/4") ; 156 MM OVERALL LENGTH (6.2")
BUNDLE DIAMETER MAXIMUM - 30 MM ; GM & UNIVERSAL
UNIT PKG.-25

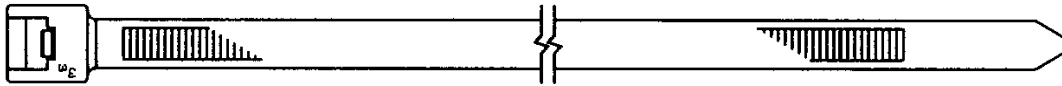

NYLON CABLE STRAPS

Part #	Color	Overall length	Bundle Diameter	Tensile Strength	Unit Pkg.
2865	BLACK	4"	UP TO 7/8"	18 lb.	100
2102	NATURAL	5"	UP TO 1-1/8"	40 lb.	50
2126	NATURAL	7-1/2"	UP TO 1-3/4"	50 lb.	50
2385	BLACK	7-1/2"	UP TO 1-3/4"	50 lb.	50
2269	NATURAL	11"	UP TO 3"	50 lb.	25
2386	BLACK	11"	UP TO 3"	50 lb.	25
2770	NATURAL	14"	UP TO 4"	50 lb.	25
2771	BLACK	14"	UP TO 4"	50 lb.	25

SOLDERLESS TERMINALS- INSULATED

RING TONGUES

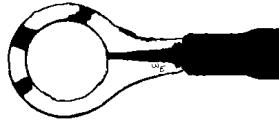

<u>PART #</u>	<u>WIRE SIZE</u>	<u>STUD SIZE</u>	<u>COLOR</u>	<u>UNIT PKG</u>
421	#22-18	#8-10	RED	50
424	#16-14	#8-10	BLUE	50
425	#16-14	#12-1/4"	BLUE	50
426	#16-14	5/16"-3/8"	BLUE	50
427	#12-10	#8-10	YELLOW	50
428	#12-10	#12-1/4"	YELLOW	50
429	#12-10	5/16"-3/8"	YELLOW	50
430	#12-10	7/16"-1/2"	YELLOW	25

BUTT CONNECTORS (NYLON)



<u>PART #</u>	<u>WIRE SIZE</u>	<u>COLOR</u>
440	#22-18	RED
441	#16-14	BLUE
442	#12-10	YELLOW

EACH UNIT PKG.-50



FEMALE QUICK DISCONNECT
#16-14 WIRE-BLUE
UNIT PKG.-50



MALE QUICK DISCONNECT
#16-14 WIRE-BLUE
UNIT PKG.-50

SPADE TONGUES

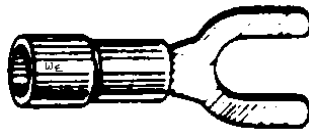

<u>PART #</u>	<u>WIRE SIZE</u>	<u>STUD SIZE</u>	<u>COLOR</u>	<u>UNIT PKG</u>
432	#22-18	#8-10	RED	50
433	#16-14	#8-10	BLUE	50
434	#12-10	#8-10	YELLOW	50



DEAD END CONNECTOR
(NYLON) #22-14 WIRE
UNIT PKG.-50

HOOK- TONGUE



<u>PART #</u>	<u>WIRE SIZE</u>	<u>STUD SIZE</u>	<u>COLOR</u>	<u>UNIT PKG</u>
437	#16-14	#8-10	BLUE	50



DEAD END CONNECTOR
(NYLON) #16-10 WIRE
UNIT PKG.-50



DISCONNECT
FEMALE-DOUBLE MALE
ADAPTER-1/4" TAB
UNIT PKG.-50



SNAP PLUG
#16-14 WIRE
(USE WITH W&E #448ǅ)
UNIT PKG.-50



STOP LIGHT CONNECTOR
#16-14 WIRE
(USE WITH W&E #449)
UNIT PKG.-50

ELECTRICAL CONNECTORS

450

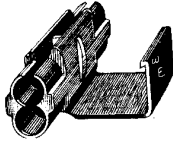

QUICK ELECTRIC CONNECTOR
 #16-14 WIRE (BLUE)
 SELF STRIPPING-CAPABLE
 OF MAKING TAP, IN-LINE, AND
 PIGTAIL SPLICES
 ONE PRESS OF PLIERS STRIPS
 AND CONNECTS FLAPS SNAP IN
 PLACE FOR INSULATION
 UNIT PKG.-25

3134

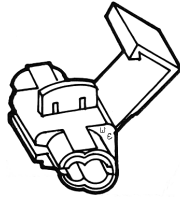

**SELF STRIPPING QUICK
 CONNECT**
 #22-18 WIRE (RED)
 UNIT PKG.-25

3135

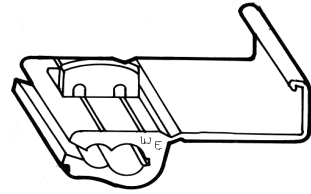

**SELF STRIPPING QUICK
 CONNECT**
 #12-10 WIRE (YELLOW)
 UNIT PKG.-25

2577

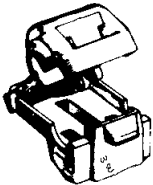

**FEMALE
 SELF-STRIPPING T-TAP**
 #16-14 WIRE (BLUE)
 (MATES WITH W&E #2576)
 UNIT PKG.-20

3136

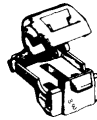

**FEMALE SELF STRIPPING
 T-TAP**
 #22-18 WIRE (RED)
 MATES WITH W&E # 3141
 UNIT PKG.-20

3137

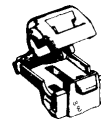

**FEMALE SELF STRIPPING
 T-TAP**
 #12-10 WIRE (YELLOW)
 MATES WITH W&E # 3143
 UNIT PKG.-20

454



**FULLY INSULATED FEMALE
 QUICK DISCONNECT**
 #16-14 WIRE (BLUE)
 (USE WITH W&E #446 OR #2576)
 UNIT PKG.-25

2576



**FULLY INSULATED
 MALE SOLDERLESS TERMINALS**
 #16-14 WIRE (BLUE)
 (MATES WITH W&E #2577 & #454)
 UNIT PKG.-25

3140

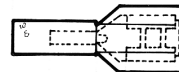

**FULLY INSULATED FEMALE
 QUICK DISCONNECT
 TERMINAL**
 #22-18 WIRE (RED)
 UNIT PKG.-25

3141

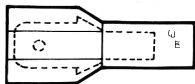

**FULLY INSULATED MALE
 QUICK DISCONNECT
 TERMINAL**
 #22-18 WIRE (RED)
 UNIT PKG.-25

3142

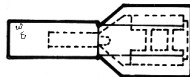

**FULLY INSULATED FEMALE
 QUICK DISCONNECT
 TERMINAL**
 #12-10 WIRE (YELLOW)
 UNIT PKG.-25

3143

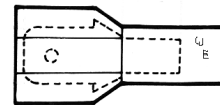

**FULLY INSULATED MALE
 QUICK DISCONNECT
 TERMINAL**
 #12-10 WIRE (YELLOW)
 UNIT PKG.-25

ELECTRICAL CONNECTORS, HEAT SHRINKABLE TUBING

453



**DOUBLE RECEPTACLE
SNAP PLUG
#16-14 WIRE
QUICK DISCONNECT
(MATES WITH W&E #449)
UNIT PKG.-25**

**QUICK DISCONNECTS
#12-10 GAUGE WIRE
COLOR-YELLOW**

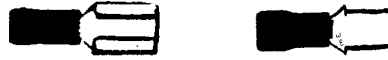

**PART #
452-FEMALE
451-MALE
EACH NUMBER UNIT PKG.-50**

**QUICK DISCONNECTS
#22-18 GAUGE WIRE
COLOR-RED**



**PART #
2595-FEMALE
2596-MALE
EACH NUMBER UNIT PKG.-50**

3138

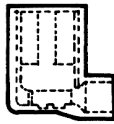

**FULLY INSULATED FLAG
FEMALE QUICK DISCONNECT TERMINALS
#22-16 WIRE (RED)
UNIT PKG.-25**

3139

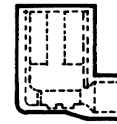

**FULLY INSULATED FLAG
FEMALE QUICK DISCONNECT TERMINALS
#16-14 WIRE (BLUE)
UNIT PKG.-25**

HEAT SHRINKABLE TUBING

**HEAVY DUTY, DUAL WALL
APPROX. 3:1 SHRINK RATIO
INSULATES, SEALS AND PROTECTS WIRES AND SPLICES**

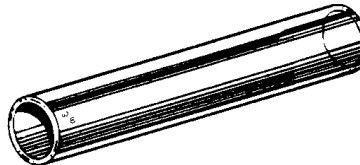

<u>PART #</u>	<u>LENGTH</u>	<u>COLOR</u>	<u>PRESHRINK I.D. (FRAC.)</u>	<u>POSTSHRINK I.D.</u>	<u>WIRE GAUGE</u>	<u>UNIT PKG.</u>
2667	12"	BLACK	.125" (1/8")	.023"	22-16	4
2668	12"	BLACK	.187" (3/16")	.060"	16-14	4
2669	12"	BLACK	.250" (1/4")	.080"	12-10	4
2670	6"	BLACK	.375" (3/8")	.118"	14-6	4
2671	6"	BLACK	.750" (3/4")	.311"	8-1	4
2672	6"	RED	.750" (3/4")	.311"	8-1	4
2673	6"	BLACK	1.00" (1")	.394"	2-4/10	4
2674	6"	RED	1.00" (1")	.394"	2-4/10	4

HEAT SHRINK TERMINALS

DESIGNED FOR WATERTIGHT, SEALED, SOLDERLESS ELECTRICAL CONNECTIONS

EASY TO USE:
INSERT STRIPPED WIRES, CRIMP, AND APPLY HEAT TO SHRINK TUBING.

BUTT CONNECTORS



<u>PART #</u>	<u>WIRE SIZE</u>	<u>COLOR</u>
2811	22-18	RED
2812	16-14	BLUE
2813	12-10	YELLOW

EACH UNIT PKG.-10

RING TERMINALS



<u>PART #</u>	<u>WIRE SIZE</u>	<u>STUD SIZE</u>	<u>COLOR</u>
2822	22-18	#8	RED
2823	22-18	#10	RED
2824	16-14	#8	BLUE
2825	16-14	#10	BLUE
2826	16-14	1/4"	BLUE
2827	16-14	3/8"	BLUE
2828	12-10	#8	YELLOW
2829	12-10	#10	YELLOW
2830	12-10	1/4"	YELLOW
2831	12-10	3/8"	YELLOW
2832	12-10	1/2"	YELLOW

EACH UNIT PKG.-10

FULLY INSULATED QUICK CONNECTS

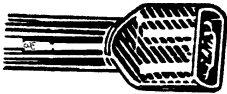

<u>PART #</u>	<u>WIRE SIZE</u>	<u>COLOR</u>
2814 (FEMALE)	22-18	RED
2815 (MALE)	22-18	RED
2816 (FEMALE)	16-14	BLUE
2817 (MALE)	16-14	BLUE
2818 (FEMALE)	12-10	YELLOW
2819 (MALE)	12-10	YELLOW

EACH UNIT PKG.-10

SPADE TERMINALS



<u>PART #</u>	<u>WIRE SIZE</u>	<u>STUD SIZE</u>	<u>COLOR</u>
2833	22-18	#10	RED
2834	16-14	#10	BLUE
2835	12-10	#10	YELLOW

EACH UNIT PKG.-10

SNAP PLUGS



<u>PART #</u>	<u>WIRE SIZE</u>	<u>COLOR</u>
2820 (MALE)	16-14	BLUE
2821 (FEMALE)	16-14	BLUE

EACH UNIT PKG.-10

HST-65



HEAT SHRINK TERMINAL ASSORTMENT

PACKED IN A CLEAR POLYPROPYLENE BOX
 (11" WIDE, 6-3/4" DEEP AND 1-3/4" HIGH)
 INCLUDES W&E #'S: 2811,2812,2813,2814,2815
 2816,2817,2818,2819,2820 & 2821

UNIT PKG.-1

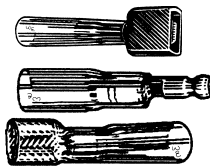

HST-65 HEAT SHRINK TERMINAL ASSORTMENT					
2811 HEAT SHRINK BUTT CONNECTOR 22-18 WIRE SIZE RED	2812 HEAT SHRINK BUTT CONNECTOR 16-14 WIRE SIZE BLUE	2812 HEAT SHRINK BUTT CONNECTOR 16-14 WIRE SIZE BLUE	2813 HEAT SHRINK BUTT CONNECTOR 12-10 WIRE SIZE YELLOW	2814 FULLY INSULATED QUICK CONNECT (FEMALE) 22-18 WIRE SIZE RED	2815 FULLY INSULATED QUICK CONNECT (MALE) 22-18 WIRE SIZE RED
2816 FULLY INSULATED QUICK CONNECT (FEMALE) 16-14 WIRE SIZE BLUE	2817 FULLY INSULATED QUICK CONNECT (MALE) 16-14 WIRE SIZE BLUE	2818 FULLY INSULATED QUICK CONNECT (FEMALE) 12-10 WIRE SIZE YELLOW	2819 FULLY INSULATED QUICK CONNECT (MALE) 12-10 WIRE SIZE YELLOW	2820 SNAP PLUG (MALE) 16-14 WIRE SIZE BLUE	2821 SNAP PLUG (FEMALE) 16-14 WIRE SIZE BLUE

WIRE LOOM

SPLIT FLEXIBLE TUBING-HIGH TEMPERATURE NYLON

PART #

SIZE

2553	1/4" I.D.	3/8" O.D.
2554	3/8" I.D.	9/16" O.D.
2555	1/2" I.D.	11/16" O.D.
2556	3/4" I.D.	15/16" O.D.



EACH UNIT PKG.-10 FT.

FUSES AND FUSE HOLDERS

2862



**FUSE HOLDER-ATO/ATC FUSES ACCOMMODATES:
3 AMP TO 30 AMP
12 GAUGE WIRE
UNIT PKG.-1**

2909



**FUSE HOLDER-MINI FUSES
ACCOMMODATES:
2 AMP TO 30 AMP
12 GAUGE WIRE
UNIT PKG.-1**

MINI FUSES-(ATM)

<u>PART #</u>	<u>AMP</u>	<u>COLOR</u>
2689	2	GRAY
2690	3	PURPLE
2691	4	PINK
2692	5	TAN
2693	7.5	BROWN
2694	10	RED
2695	15	BLUE
2696	20	YELLOW
2697	25	WHITE
2698	30	GREEN

EACH UNIT PKG.-10

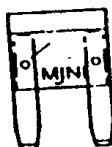

LOW PROFILE MINI FUSES (LATE MODEL TOYOTA)

<u>PART #</u>	<u>AMP</u>	<u>COLOR</u>
3122	5	TAN
3123	7.5	BROWN
3124	10	RED
3125	15	BLUE
3126	20	YELLOW
3127	25	NATURAL
3128	30	GREEN

EACH UNIT PKG.-5



AGC (GLASS) FUSES

<u>PART #</u>	<u>AMP</u>
2868	1
2869	2
2870	3
2871	4
2872	5
2873	7.5
2874	10
2875	15
2876	20
2877	25
2878	30

EACH UNIT PKG.-10



MAXI FUSES-

<u>PART #</u>	<u>AMP</u>	<u>COLOR</u>
2914	20	YELLOW
2915	30	GREEN
2916	40	ORANGE
2917	50	RED
2918	60	BLUE

EACH UNIT PKG.-2

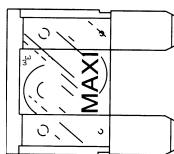

AUTO FUSES- (ATO/ ATC)

<u>PART #</u>	<u>AMP</u>	<u>COLOR</u>	<u>UNIT PKG.</u>
2540	5	TAN	5
2808	7.5	BROWN	5
2541	10	RED	5
2542	15	BLUE	5
2543	20	YELLOW	5
2544	25	WHITE	5
2545	30	GREEN	5

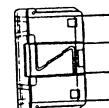

AUTOMOTIVE BULBS (PICTURES NOT ACTUAL SIZE)

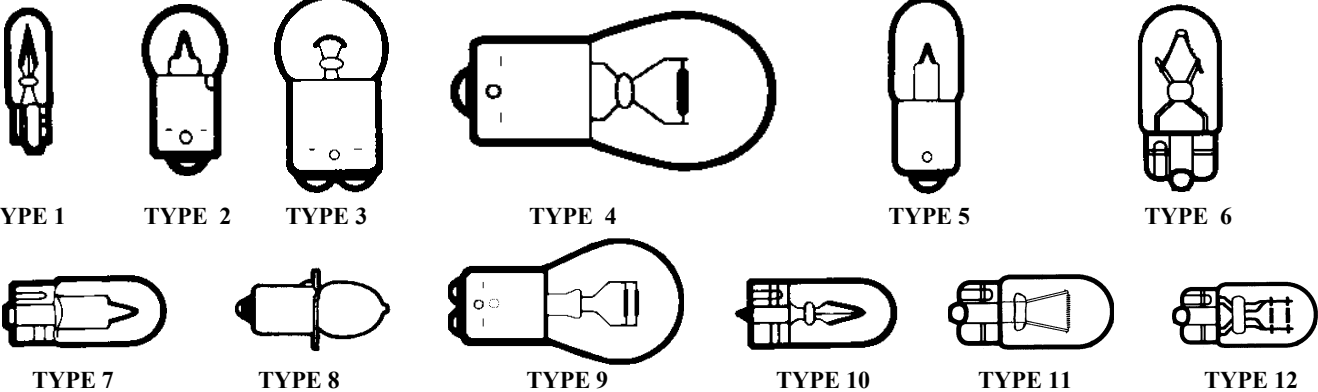

<u>PART #</u>	<u>TYPE</u>	<u>DESCRIPTION</u>
T-24	1	COURTESY
T-24NA	1	SIDE MARKER- GM
37	1	INSTRUMENT, INDICATOR, STEP/COURTESY-CHRYSLER, DODGE, FORD, GM, GMC, HYUNDAI, JEEP, LINCOLN, MAZDA, MERCURY, MITSUBISHI, SUBARU, SUZUKI, TOYOTA
53	2	INSTRUMENT, INDICATOR, STEP/COURTESY-ACURA, CHRYSLER, DODGE, JEEP, MITSUBISHI, SAAB
57	2	INSTRUMENT PANEL
67	2	PARK, TAIL, LICENSE PLATE
73	1	INSTRUMENT, STEP/COURTESY-DODGE, GM, GMC, INFINITI, MITSUBISHI, SATURN
74	1	INSTRUMENT PANEL
89	2	INSTRUMENT PANEL
90	3	DOVE, UNDER HOOD, INDICATOR, STEP/COURTESY-CHRYSLER, DODGE, GM, JEEP
93	4	UNDER HOOD, TRUNK-GM, GMC, ISUZU
97	2	COURTESY, DOVE, LICENSE PLATE-FORD AND IMPORTS
158	7	MARKER, DOVE, TRUNK, INSTRUMENT, STEP/COURTESY-CHRYSLER, DODGE, GM, HONDA, HYUNDAI, INFINITI, JEEP, MAZDA, MITSUBISHI, NISSAN, SUBARU, TOYOTA
T-161	10	MARKER, INSTRUMENT, INDICATOR, STEP/COURTESY-CHRYSLER, DODGE, GM, GMC, FORD, INFINITI, JEEP, LINCOLN, MERCURY, NISSAN, RENAULT, SATURN
168	7	SIDE MARKER, STOP-GM, FORD, CHRYSLER, HONDA AND TOYOTA
194	6	SIDE MARKER, INSTRUMENT, LICENSE PLATE
194NA	6	AMBER MARKER, INSTRUMENT, LICENSE PLATE
199	4	TURN, BACK-UP- MEDIUM AND HEAVY DUTY TRUCKS
904	6	MARKER, STEP/COURTESY-DODGE, FORD, MERCURY
906	6	HIGH MOUNT STOP
906NA	6	DOVE
912	6	INTERIOR, DOVE
912NA	6	INTERIOR, DOVE
T-916	6	TAIL LIGHTS- CHRYSLER, FORD
916NA	6	SIDE MARKER- FORD/MERCURY, WINSTAR, EXPLORER, LINCOLN, MUSTANG
T-921	6	STOP AND BACKUP- US AND IMPORTS
921NA	6	STOP AND BACKUP- US AND IMPORTS
T-922	6	BACK-UP, THIRD BRAKE LIGHT-CHRYSLER, DODGE, FORD
1003	4	COURTESY, DOVE, TRUNK- CHRYSLER AND GM
1004	9	DOVE, STEP/COURTESY-CHRYSLER, GM
T-1034	9	PARK, TURN SIGNAL-OLDER US MODELS, ISUZU-'94 & UP

EACH UNIT PKG.-10

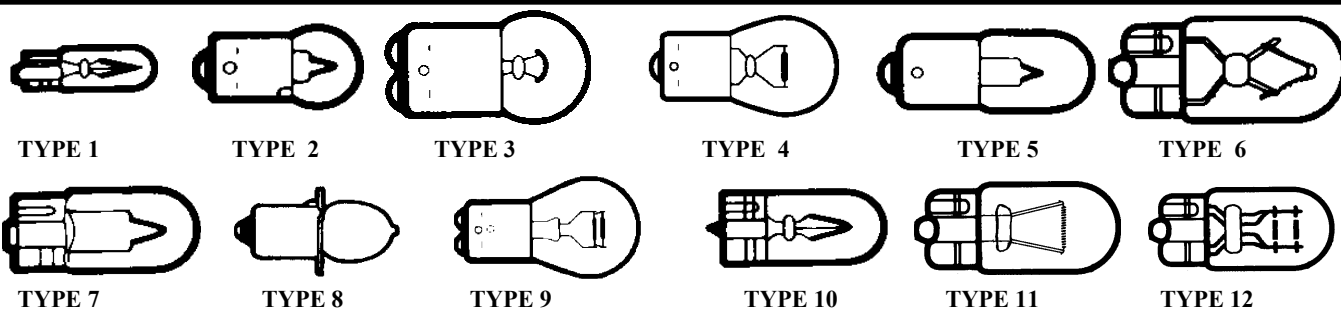

AUTOMOTIVE BULBS (PICTURES NOT ACTUAL SIZE)



<u>PART #</u>	<u>TYPE</u>	<u>DESCRIPTION</u>
T-1073	4	SIGNAL, BACK-UP, PARKING, FOG-ISUZU, TOYOTA
T-2357	9	SIGNAL, PARKING
1141	4	BACKUP
1142	9	TRUNK, STEP/COURTESY-GM, GMC
1156	4	SIGNAL, TAIL, STOP AND PARKING
1156NA	4	SIGNAL, TAIL, STOP
1157	9	SIGNAL, TAIL, STOP AND PARKING
1157N	9	(NICKEL BASE) (REPLACES 7528, 12499, 17916) STOP, TAIL, MARKER
1157NA	9	AMBER SIGNAL, PARKING
1295	4	TURN SIGNAL- JEEP
1295NA	4	TURN SIGNAL- JEEP GRAND CHEROKEE
1445	2	SIDE MARKER- TRUCKS
1816	5	INSTRUMENT, INDICATOR-GM, FORD, MERCURY
1891	5	INTERIOR
1893	5	DOMES, INSTRUMENT PANEL-GM & FORD
1895	2	INSTRUMENT, GLOVE BOX-GM & FORD
2057	9	SIGNAL, TAIL, STOP & PARKING
2057NA	9	AMBER SIGNAL, PARKING
2357NA	9	AMBER SIGNAL, PARKING
3496	9	TAIL, STOP, MARKER & SIGNAL- HONDA, FORD PROBE
3497	9	DIRECTIONAL, STOP- HONDA & FORD PROBE
7440	11	TURN SIGNAL, BACKUP-ACURA, HONDA, ISUZU, LEXUS, SAAB-'96 & UP
7441	11	BACK UP-GM AVALANCHE, SUBURBAN, TAHOE, YUKON, ESCALADE
7443	12	TAIL, STOP LIGHT, ACURA, HONDA, ISUZU, LEXUS, SAAB- '96 & UP, SUBARU
7440NA	11	(NATURAL AMBER) TURN SIGNAL, BACK-UP-ACURA, HONDA, LEXUS
7443NA	12	(NATURAL AMBER) TAIL, STOP-ACURA, HONDA, LEXUS
7444NA	12	(AMBER) PARK, SIGNAL, MARKER-DODGE, SUZUKI, HONDA, CHEVROLET-'09 & UP
12023	2	DOMES, MAP, STEP/COURTESY-AUDI, JAGUAR, SAAB, VOLVO, VW
12961	6	SIGNAL, MARKER, TAIL, LICENSE PLATE-TOYOTA, HONDA, VW, VOLVO,LEXUS, BMW SAAB, JAGUAR, PORSCHE
12498	4	CORNERING, BACK-UP, SIGNAL, STOP, HI-MOUNT STOP-EUROPEAN CARS
12516	10	INSTRUMENT- BMW, JAGUAR, MERCEDES, VOLVO
12594	9	TAIL, STOP, PARKING, MARKER-BMW, MERCEDES, SAAB,PORSCHE
12814	5	TAIL, MARKER, PARK, LICENSE PLATE--AUDI, PORSCHE, MERCEDES, VW
12821	5	TAIL, MARKER, SIGNAL, PARKING, LICENSE PLATE-EUROPEAN CARS
17638NA	4	TURN SIGNAL- PORSCHE, VOLVO
17640	4	OFFSET TABS, NICKEL BASE-BMW AND OTHER EUROPEAN CARS
PR-2	8	FLASH LIGHT- 2 CELL
PR-12	8	FLASH LIGHT- 5 CELL

EACH UNIT PKG.-10

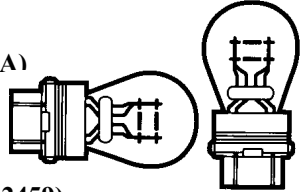
AUTOMOTIVE BULBS (PICTURES NOT ACTUAL SIZE)

<u>W&E Part #</u>	<u>Description</u>	
3057	SIGNAL, TAIL, STOP, BACKUP (REPLACES 2457 & 2458)	
3057NA	AMBER SIGNAL, PARKING (REPLACES 2457NA & 2458NA)	
3155	HIGH MOUNT STOP- GM-'96 & UP	
3156	BACKUP	
3156NA	AMBER PARKING, TURN SIGNAL- FORD	
3157	SIDE MARKER, SIGNAL, STOP, TAIL (REPLACES 2458 & 2459)	
3157NA	AMBER PARKING, TURN SIGNAL, SIDE MARKER (REPLACES 2458NA & 2459NA)	
3357	PARKING, TURN SIGNAL, MARKER & TAIL LAMP- GM & FORD	
3357NA	AMBER PARKING, TURN SIGNAL, MARKER & TAIL LAMP- GM & FORD	
3457	PARKING, TURN SIGNAL, MARKER & TAIL LAMP- GM & FORD	
3457NA	AMBER PARKING, TURN SIGNAL, MARKER & TAIL LAMP- GM & FORD	
3757NA	AMBER SIGNAL, PARKING, DAYTIME RUNNING LIGHTS-GM	
4057K	TURN SIGNAL, TAIL, STOP-FORD 2006 & UP	
4114K	DAYTIME RUNNING LIGHTS-GM TRUCKS-2002 & UP	
4157K (WILL REPLACE 3157K)	DAYTIME RUNNING LIGHTS-GM 2000 & UP, NISSAN-PARK & TURN	
4157NAK	AMBER PARKING, TURN, FRONT MARKER-GM, CHRYSLER, TOYOTA EACH UNIT PKG.-10	

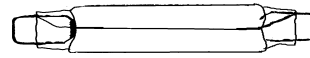







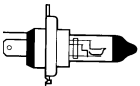
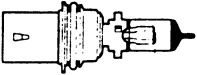
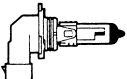
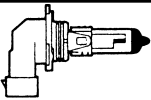
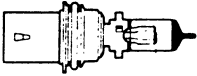
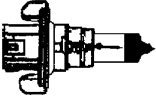

<u>W&E Part #</u>	<u>Description</u>
272	INTERIOR/DOME (REPLACES DE-3022 & 13050)-MAZDA, TOYOTA, NISSAN, HONDA, VOLVO
317	INTERIOR/DOME (REPLACES DE-3175 & 12100)-MAZDA, TOYOTA, NISSAN, HONDA, VOLVO
211-2	DOME, COURTESY- AMC, GM, FORD, CHRYSLER- (REPLACES 212-2)
561	DOME, UNDER HOOD- GM -'77 & UP
12818	TRUNK, GLOVE, STEP, COURTESY (REPLACES DE-3021, 6428) IMPORTS
12844	TRUNK, GLOVE, STEP, COURTESY (REPLACES DE-3423, 6418, 11005) IMPORTS
12854	DOME, STEP, COURTESY, UNDER HOOD (REPLACES-DE-3425, 6461,11004)
12866	DOME, MAP, STEP/COURTESY, TRUNK, GLOVE-AUDI, BMW, CADILLAC, JAGUAR MERCEDES, PORSCHE, SAAB, VOLVO, VW EACH UNIT PKG.-10

<u>W&E #</u>	<u>WAGNER #</u>	<u>EUROPEAN/ JAPANESE INTERCHANGE</u>				<u>GE #</u>
		<u>SYLVANIA #</u>	<u>PHILLIPS #</u>	<u>NARVA #</u>		
272	13050	DE3022	DE3022	17094	DE3022	
317	12100	DE3175	DE3175	17315	DE3175	
9003	9003	9003	9003	48881		
12023	47830	64111	12023	17830	58540	
12498	17635	7506	12498	17635	P21W	
12516	17037	2721	12516	17037		
12594	17881	7225	12594	17881	P21/4W	
12814	17311	5008	12814	17311	R10W	
12818	11006	6428	12818	17094	DE3021	
12821	17171	5007	12821	17171	R5W	
12844	11005	6418	12844	17125	DE3423	
12854	11004	6461	12854	17316	DE3425	
12866	17314	6411	12866	17314	DE7576	
12961	17177	2825	12961	17177	W5W	
1157N	17916	7528	12499	17916	P21/5W	
17638NA	17638NA	7507	12496	17638	PY21W	
H-7	H-7	64210	12972			

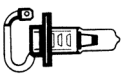
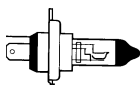
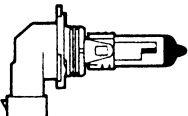
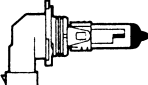
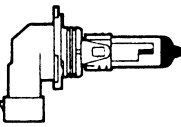
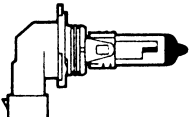
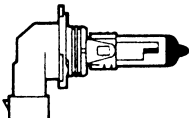
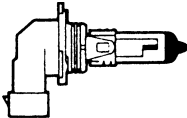

HALOGEN BULBS (PICTURES NOT ACTUAL SIZE)

<p>9003</p>  <p>FOR MOST JAPANESE CARS UNIT PKG.-1</p>	<p>9004</p>  <p>DUAL BEAM HEAD LAMP UNIT PKG.-1</p>	<p>9005</p>  <p>HIGH BEAM HEAD LAMP UNIT PKG.-1</p>	<p>9006 (HB4)</p>  <p>LOW BEAM HEAD LAMP UNIT PKG.-1</p>	
<p>9007</p>  <p>DUAL BEAM HEADLAMP FORD & CHRYSLER UNIT PKG.-1</p>	<p>H-13 (9008)</p>  <p>DUAL BEAM HEAD LAMP FORD F-150, DODGE DURANGO, FORD MUSTANG, NISSAN SENTRA 2004 & UP UNIT PKG.-1</p>	 <p>9005SX-HIGH BEAM HEAD LAMP</p>  <p>9006SX-LOW BEAM HEAD LAMP CHRYSLER MINIVANS UNIT PKG.-1</p>		
<p>H-1</p>  <p>HALOGEN LAMP- ACURA, AUDI, BMW, HONDA, HYUNDAI, INFINITY, JAGUAR, MERCEDES, KIA, NISSAN, PORSCHE, SUBARU, VW, VOLVO UNIT PKG.-1</p>	<p>H-3</p>  <p>HALOGEN FOG LAMP-ACURA, AUDI, BMW, GM, HONDA, CHRYSLER, GMC, HYUNDAI, INFINITY, JEEP, JAGUAR, LAND ROVER, LEXUS, MERCEDES, MAZDA, MITSUBISHI, NISSAN, SUBARU, TOYOTA, VW, VOLVO UNIT PKG.-1</p>		<p>H-7</p>  <p>HALOGEN LAMP VW, BMW, PORSCHE UNIT PKG.-1</p>	
<p>H-8</p>  <p>HALOGEN FOG LAMP (35 WATTS) BMW, MERCEDES UNIT PKG.-1</p>	<p>H-9</p>  <p>HALOGEN LAMP (65 WATTS) HEADLAMP AUDI, MAZDA, MINI COOPER, VW (SELECTED MODELS) UNIT PKG.-1</p>	<p>H-10 (9145) (SUB. FOR 9140)</p>  <p>HALOGEN FOG LAMP (45 WATTS) CADILLAC, TOYOTA, CHEVY & FORD TRUCKS-2003 & UP UNIT PKG.-1</p>	<p>H-11</p>  <p>HALOGEN HEADLAMP/FOG LAMP-(55 WATTS) ACURA, AUDI, CHEVY MALIBU, HONDA, LAND ROVER, LINCOLN, MAZDA, MINI COOPER, MITSUBISHI, NISSAN, PONTIAC, SATURN, TOYOTA, VW UNIT PKG.-1</p>	
<p>9011 (HIR1)</p>  <p>HALOGEN HEAD LAMP-HIGH BEAM (65 WATTS) CHEVY AVALANCHE INFINITY-2000 & UP UNIT PKG.-1</p>	<p>H-12 (9055)</p>  <p>(ALSO KNOWN AS- 9055) AUTOMOTIVE BULB FOG LAMP JEEP 1997 & UP UNIT PKG.-1</p>	<p>MHL-880</p>  <p>HALOGEN FOG LAMP GM & UNIVERSAL UNIT PKG.-1</p>	<p>MHL-889</p>  <p>MINI HALOGEN RIGHT ANGLE HIGH MOUNT STOP UNIT PKG.-1</p>	<p>MHL-890</p>  <p>MINI HALOGEN SIGNAL, PARK, BACK UP UNIT PKG.-1</p>

HALOGEN BULBS (PICTURES NOT ACTUAL SIZE)

MHL-891



**MINI HALOGEN
HIGH MOUNT STOP
UNIT PKG.-1**

MHL-899



**MINI HALOGEN LAMP
DRIVING LIGHTS
FORD
UNIT PKG.-1**

2040



**HALOGEN LAMP
CENTER GRILLE
MERCURY SABLE-'86 & UP
MERCURY VILLAGER-'96 & UP
UNIT PKG.-1**

HIGH INTENSITY DISCHARGE (HID) LAMPS

D2R

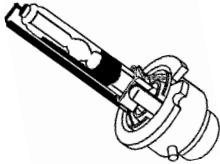

**HIGH INTENSITY DISCHARGE (HID) LAMP
(USE WITH REFLECTOR SYSTEMS)
HEADLAMPS-
ACURA, AUDI, INFINITI, LEXUS, LINCOLN,
MERCEDES, MINI COOPER, NISSAN, TOYOTA
VOLVO-2000 & UP (SELECTED MODELS)
UNIT PKG.-1**

D2S

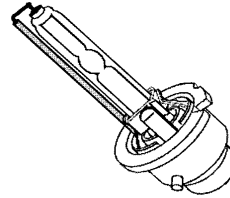

**HIGH INTENSITY DISCHARGE (HID) LAMP
(USE WITH PROJECTION SYSTEMS
WITH LIGHT SHIELD)
ACURA, AUDI, BMW, CHRYSLER, HONDA,
INFINITI, JAGUAR, LEXUS, MAZDA,
MERCEDES, MITSUBISHI, NISSAN, TOYOTA
SAAB, VW-2000 & UP (SELECTED MODELS)
UNIT PKG.-1**

DAYTIME RUNNING LIGHT APPLICATION GUIDE

<u>MAKE/MODEL</u>	<u>YEAR</u>	<u>BULB</u>
<u>ACURA NSX</u>	'98-'04	1156
<u>AM GENERAL:</u>		
HUMMER	'03-'04	4157K
<u>AUDI:</u>		
A4	'02-'04	12961
A4 AVANT	'02-'04	12961
A6	'02-'04	12961
A6 AVANT	'02-'04	12961
RS6	'03-'04	12961
S4	'02-'04	12961
S4 AVANT	2004	12961
S4 AVANT	2002	12961
S6 AVANT	'02-'04	12961
S8	'01-'02	12961
<u>BUICK LESABRE</u>	'99-'04	3156
<u>CADILLAC:</u>		
ESCALADE	'02-'04	4157K
SRX	2004	3757NA
XLR	2004	3757NA
<u>CHEVROLET:</u>		
AVALANCHE	'02-04	3457
COLORADO	2004	3757NA
SILVERADO PICK-UP	'99-'04	4157K
SUBURBAN	'00-'04	4157K
TAHOE	'00-'04	4157K

<u>MAKE/MODEL</u>	<u>YEAR</u>	<u>BULB</u>
<u>CHEVROLET:</u>		
VENTURE	'00-'04	4157NA
VENTURE	'97-'99	3157NA
<u>CHRYSLER:</u>		
CIRRUS	'98-'00	3157NA
PROWLER	2002	3157NA
<u>DODGE STRATUS</u>	'98-'00	3157NA
<u>FORD FOCUS</u>	'02-'04	3157
<u>GMC:</u>		
CANYON	2004	3757NA
DENALI/DENALI XL	'01-'04	4157K
SIERRA	'99-'04	4157K
YUKON/YUKON XL	'00-'04	4157K
<u>MERCURY VILLAGER</u>	'00-'02	3157NA
<u>NISSAN:</u>		
ALTIMA	'00-01	3457NA
MAXIMA	2004	1156
QUEST	'00-'02	3157NA
OLDS SILHOUETTE	'97-'03	3157NA
PLYMOUTH BREEZE	'98-'00	3157NA
<u>PONTIAC:</u>		
MONTANA	'99-'04	3157NA
TRANS SPORT	'97-'98	3157NA
<u>TOYOTA 4RUNNER</u>	'03-'04	4157NAK
<u>VW PASSAT</u>	'98-'01	H-7



BULB SOCKETS/ PIGTAIL CONNECTORS

3029

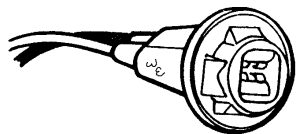

(GM-6298935, 6294015, 8918527, 8901283)
 (FORD-D7AZ-13412-A, D40Z-13410E, D7FZ-13412-A)
 SIDE MARKER LIGHT SOCKET
 USE-67, 158, 194 OR 194NA BULBS

UNIT PKG.-2

3030



(12083005)
 SOCKET- DOUBLE CONTACT BULBS
 BACK-UP, PARK, STOP, TAIL, TURN
 GM-'88-'98
 USE-3057, 3157, 3057NA OR 3157NA BULBS
 UNIT PKG.-1

3031

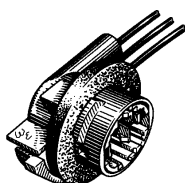

(12083680)
 SOCKET
 DOUBLE CONTACT BULBS
 BACK-UP, PARK, STOP, TAIL,
 TURN
 GM-'88-'98
 USE-3057, 3157
 OR 3157NA BULBS
 UNIT PKG.-1

3032



(GM-12001470, 12116169,
 12078178)
 (FORD-EOSZ-15A442B)
 CORNER MARKER
 SOCKET
 TAIL, STOP & LICENSE
 USE 158, 194
 OR 194NA BULBS
 UNIT PKG.-1

3033

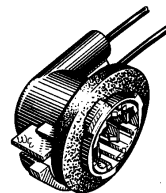

(12085330)
 SOCKET- BACK-UP,
 DRIVING, LICENSE
 PLATES
 GM-'88 & UP
 USE 3156 BULB
 UNIT PKG.-1

3034

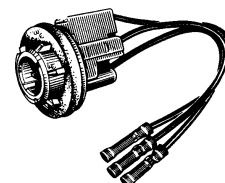

(D4LY-13410-A)
 SOCKET-DOUBLE
 CONTACT BULBS
 STOP, TAIL, TURN
 7" WIRE LEAD WITH
 BUTT SPLICES
 FORD-'73-'98
 USE 1157 BULB
 UNIT PKG.-1

2846

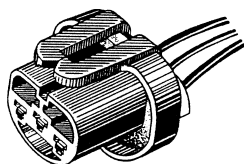

(GM-12048369)
 UNIVERSAL HEADLIGHT SOCKET
 (4 HEADLIGHT SYSTEM)FOR 9004 & 9007 BULBS
 UNIT PKG.-2

2847

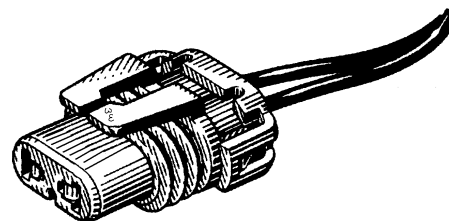

UNIVERSAL HEADLIGHT SOCKET
 FOR 9006 BULBS (LOW BEAM)
 UNIT PKG.-2

2934

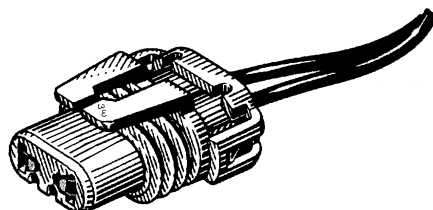

UNIVERSAL HEADLIGHT SOCKET
 FOR 9005 AND H-10 BULBS (HIGH BEAM)
 UNIT PKG.-2

3283



HEADLIGHT SOCKET
 FOR H-13 BULB
 (SAME AS 9008 BULB)
 FORD, NISSAN
 UNIT PKG.- 1

BULB SOCKETS/ PIGTAIL CONNECTORS

3195

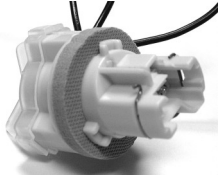

(E8PZ-13411A)
SOCKET
 TURN SIGNAL, STOP, TAIL, PARK & MARKER
 3157 BULB-FORD
 UNIT PKG.-2

3196

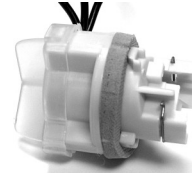

(E8PZ-13411B)
SOCKET
 TURN SIGNAL, STOP, TAIL, PARK & MARKER
 3157 BULB-FORD
 UNIT PKG.-2

3197

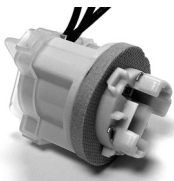

(E8PZ-13411C)
SOCKET-TURN SIGNAL, STOP, TAIL, PARK & MARKER, 3157 BULB-FORD
 UNIT PKG.-2

3198

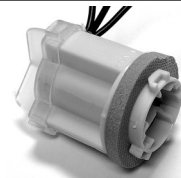

(E8PZ-13411D)
SOCKET
 TURN SIGNAL, STOP, TAIL, PARK & MARKER
 3157 BULB-FORD
 UNIT PKG.-2

3199

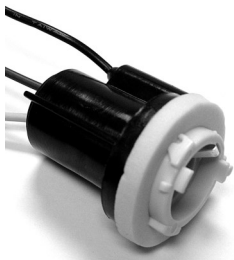

(GM-12013813, 8919916)
SOCKET-DOUBLE CONTACT
 STOP & TAIL
 1157 BULB
 UNIT PKG.-2

3200

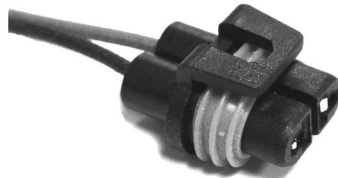

SOCKET
 FOR H8, H9 AND H11 BULBS
 UNIT PKG.-1

3227

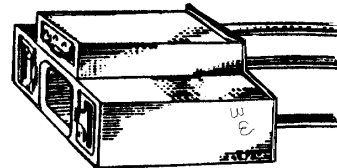

SOCKET-
 FOR 9003 (H4) BULBS
 UNIT PKG.-2

3201

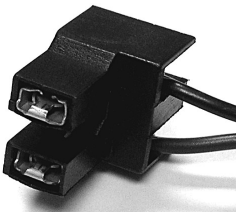

SOCKET
 FOR H7 BULB
 UNIT PKG.-2

3213

(D3AZ-13410-D)
(D4SZ-13410-E)
(D4OZ-13410-D)
FORD PIGTAIL
DOUBLE CONTACT
SOCKET - SIGNAL,
STOP & TAIL LIGHT



UNIT PKG.-2

3324



SOCKET
 FOR H8 AND H11 BULBS
 UNIT PKG.-1



SHIMS-PLATED

UNIVERSAL BALL JOINT & CASTER & CAMBER SHIMS-PLATED

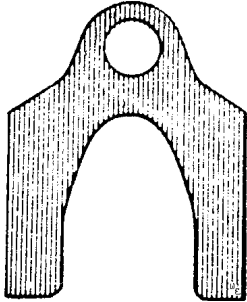

**1-1/2" X 1-3/16"
5/8" MAXIMUM SLOT**

<u>PART #</u>	<u>THICKNESS</u>
973	1/32"
974	1/16"
975	1/8"

EACH UNIT PKG.-50

C TYPE BODY SHIMS



15/16" O.D., 3/8" SLOT

<u>PART #</u>	<u>THICKNESS</u>
3144	1/16"
3145	1/8"

EACH UNIT PKG.-50

EACH UNIT PKG.-50

COWL-HOOD-FENDER SHIMS-PLATED

965

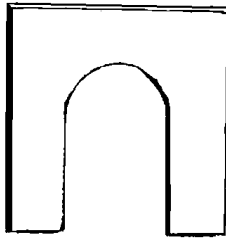

**1-1/16" X 1-1/4"
1/16" THICK- 1/2" SLOT**

UNIT PKG.-50

966

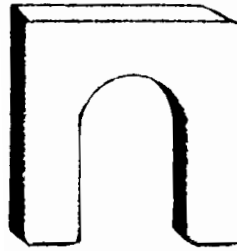

**1-1/4" X 1-1/8"
1/8" THICK- 3/8" SLOT**

UNIT PKG.-50

969

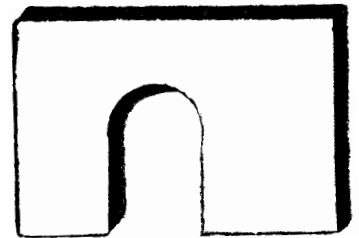

**1-3/4" X 1-1/4"
1/8" THICK- 1/2" SLOT**

UNIT PKG.-50

970



**1-3/8" X 1-1/4"
1/16" THICK- 5/8" SLOT
UNIT PKG.-50**

971



**1-3/8" X 1-1/4"
1/8" THICK- 5/8" SLOT
UNIT PKG.-50**

972



**1-3/8" X 1-1/4"
3/16" THICK- 5/8" SLOT
UNIT PKG.-25**

2448

**1-1/4" X 1-1/8"
1/16" THICK- 3/8" SLOT
UNIT PKG.-50**

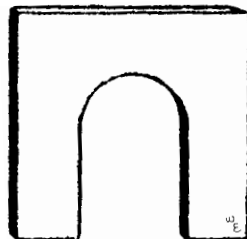

2449

**1-1/8" X 1-1/4"
1/8" THICK- 1/2" SLOT
UNIT PKG.-50**

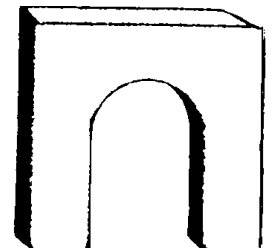

METRIC HEX HEAD CAP SCREWS

USS HEX HEAD CAP SCREWS

DIN 933 ZINC PLATED

GRADE 5 ZINC PLATED

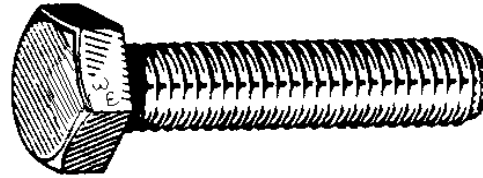
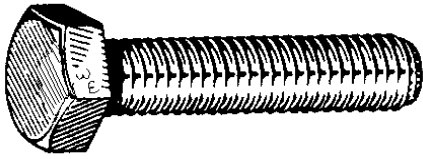

<u>W&E #</u>	<u>SIZE</u>	<u>UNIT PKG.</u>
5401	4 X 16 MM	25
5402	4 X 20 MM	25
5501	5 X 16 MM	25
5502	5 X 20 MM	25
5601	6 X 16 MM	25
5602	6 X 20 MM	25
5603	6 X 25 MM	25
5604	6 X 30 MM	25
5606	6 X 40 MM	25
5608	6 X 50 MM	25
5801	8 X 16 MM	25
5802	8 X 20 MM	25
5803	8 X 25 MM	25
5804	8 X 30 MM	25
5805	8 X 35 MM	25
5806	8 X 40 MM	25
5808	8 X 50 MM	15
5810	8 X 60 MM	15
5102	10 X 20 MM	15
5103	10 X 25 MM	15
5104	10 X 30 MM	15
5106	10 X 40 MM	15
5108	10 X 50 MM	15
5110	10 X 60 MM	15
5124	12 X 30 MM	10
5126	12 X 40 MM	10

<u>W&E #</u>	<u>SIZE</u>	<u>UNIT PKG.</u>
4101	1/4 X 1/2"	100
4102	1/4 X 3/4"	100
4103	1/4 X 1"	100
4104	1/4 X 1-1/4"	100
4105	1/4 X 1-1/2"	50
4107	1/4 X 2"	50
4112	5/16 X 3/4"	50
4113	5/16 X 1"	50
4114	5/16 X 1-1/4"	50
4115	5/16 X 1-1/2"	50
4117	5/16 X 2"	50
4119	5/16 X 2-1/2"	50
4122	3/8 X 3/4"	50
4123	3/8 X 1"	50
4124	3/8 X 1-1/4"	50
4125	3/8 X 1-1/2"	50
4126	3/8 X 1-3/4"	25
4127	3/8 X 2"	50
4129	3/8 X 2-1/2"	25
4133	7/16 X 1"	50
4135	7/16 X 1-1/2"	25
4137	7/16 X 2"	25
4145	1/2 X 1-1/2"	25
4147	1/2 X 2"	25
4149	1/2 X 2-1/2"	15

**METRIC NUTS- ZINC PLATED
DIN 934**

USS NUTS- ZINC PLATED

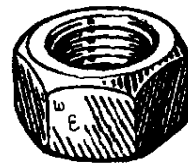
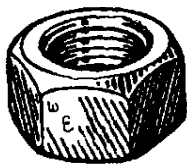

<u>W&E #</u>	<u>SIZE</u>	<u>UNIT PKG.</u>
5004	4 X .7 MM	100
5005	5 X .8 MM	100
5006	6 X 1 MM	100
5008	8 X 1.25 MM	100
5010	10 X 1.5 MM	50
5012	12 X 1.75 MM	25

<u>W&E #</u>	<u>SIZE</u>	<u>UNIT PKG.</u>
4001	1/4"-20	100
4002	5/16"-18	100
4003	3/8"-16	100
4004	7/16"-14	100
4005	1/2"-13	50



GRADE 8 HEX HEAD CAP SCREWS & NUTS USS ZINC PLATED

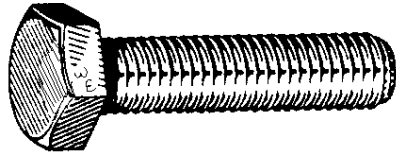

<u>W&E #</u>	<u>SIZE</u>	<u>UNIT PKG.</u>
2531	1/2-13 X 2-1/2"	10
2532	1/2-13 X 3"	10
2533	5/8-11 X 2"	10
2434	5/8-11 X 3"	5
2435	5/8-11 X 3-1/2"	5

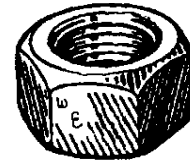

<u>W&E #</u>	<u>SIZE</u>	<u>UNIT PKG.</u>
2530	1/2"-13	25
2436	5/8"-11	10

HIGH STRENGTH USS FLAT WASHERS ZINC/YELLOW PLATED



<u>W&E #</u>	<u>SIZE</u>	<u>O.D.</u>	<u>UNIT PKG.</u>
2593	1/2"	1-3/8"	25
2594	5/8"	1-3/4"	15

FENDER WASHERS FLAT TYPE-ZINC PLATED

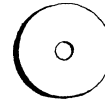

<u>W&E #</u>	<u>SIZE</u>
951	1/4" X 1-1/4"
952	5/16" X 1-1/4"
953	5/16" X 1-1/2"
957	3/8" X 1-1/2"

EACH UNIT PKG.- 50

SAE FLAT WASHERS- ZINC



<u>W&E #</u>	<u>SIZE</u>	<u>UNIT PKG.</u>
2601	1/4"	100
2602	5/16"	100
2603	3/8"	100
2604	7/16"	100
2605	1/2"	50

USS FLAT WASHERS- ZINC



<u>W&E #</u>	<u>SIZE</u>
4200	3/16"
4201	1/4"
4202	5/16"
4203	3/8"
4204	7/16"
4205	1/2"

EACH UNIT PKG.- 1 LB.

METRIC FLAT WASHERS- ZINC



<u>W&E #</u>	<u>SIZE</u>	<u>UPKG</u>
5970	4 MM	100
5971	5 MM	100
5949	6 MM	100
5950	8 MM	100
5951	10 MM	100
3222	12 MM	50

SPRING TYPE LOCK WASHERS- ZINC PLATED

<u>W&E #</u>	<u>SIZE</u>	<u>W&E #</u>	<u>SIZE</u>
4210	3/16"	5972	4 MM
4211	1/4"	5973	5 MM
4212	5/16"	5956	6 MM
4213	3/8"	5957	8 MM
4214	7/16"	5958	10 MM
4215	1/2"	3223	12 MM(UPKG-50)



EACH UNIT PKG.- 100

**HIGH SPEED PANEL "PUNCH" TWIST DRILLS
HIGHEST QUALITY—US MADE— BRIGHT
APPROX.— 2" OVERALL LENGTH, NON WALKING SPLIT POINT**

DOUBLE END DRILLS

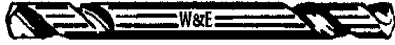

<u>PART #</u>	<u>DECIMAL SIZE</u>	<u>FRACTIONAL EQUIV.</u>	<u>UNIT PKG.</u>
BPX-1/8	.125	1/8"	12
BPX-30	.1285	1/8"	6
BPX-11	.191	3/16"	6
BPX-1/4	.253	1/4"	6

**SINGLE END DRILLS
IN RE-USABLE PLASTIC BAG**



<u>PART #</u>	<u>DECIMAL SIZE</u>	<u>FRACTIONAL EQUIV.</u>	<u>PCS. PER BAG</u>
BPD-7/64	.1094	7/64"	12
BPD-1/8	.125	1/8"	12

**HIGH SPEED COBALT SPOT WELD DRILLS
IMPROVED DESIGN- MADE IN USA -OVERALL LENGTH-2.25"**

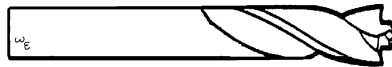

<u>PART #</u>	<u>SIZE</u>	<u>UNIT PKG.</u>
SWD-8	8 MM DIAM. DRILL FOR 5/16" SPOT WELD	5
SWD-10	10 MM DIAM. DRILL FOR 3/8" SPOT WELD	5

**SPOT WELD DRILL BITS
FOR NEW ULTRA HIGH STRENGTH STEEL (BORON)
MADE IN USA**



<u>PART #</u>	<u>SIZE</u>
BSWD-83	(3 FLUTE) UNIT PKG.-1 8MM (5/16")

**HIGH SPEED TWIST DRILLS IN SETS
JOBBER LENGTH DRILLS IN DRILL INDEX**

**HIGH QUALITY
US MADE**

**135 DEGREE SPLIT POINT
BRIGHT FINISH**

DS-13 & DI-3



DS-15 & DI-5



DS-29 & DI-9



DS-13– 13 SIZES H.S. JOBBER LENGTH DRILLS: 1/16”-1/4” BY 64ths
DS-15– 15 SIZES H.S. JOBBER LENGTH DRILLS: 1/16”-1/2” BY 32nds
DS-29– 29 SIZES H.S. JOBBER LENGTH DRILLS: 1/16”-1/2” BY 64ths

DRILL INDEX ONLY– WITHOUT DRILLS

DI-3– 13 SIZES H.S. JOBBER LENGTH DRILLS: 1/16”-1/4” BY 64ths
DI-5– 15 SIZES H.S. JOBBER LENGTH DRILLS: 1/16”-1/2” BY 32nds
DI-9– 29 SIZES H.S. JOBBER LENGTH DRILLS: 1/16”-1/2” BY 64ths

ALL UNIT PKG.-1

**HIGH SPEED STEEL TWIST DRILLS
135 DEGREE SPLIT POINT-US MADE
FRACTIONAL SIZES - JOBBER LENGTH - BRIGHT FINISH**

<u>SIZE</u>	<u>LENGTH INCHES</u>	<u>UPKG.</u>	<u>SIZE</u>	<u>LENGTH INCHES</u>	<u>UPKG.</u>	<u>SIZE</u>	<u>LENGTH INCHES</u>	<u>UPKG.</u>
1/16	1-7/8	10	7/32	3-3/4	5	3/8	5	3
5/64	2	10	15/64	3-7/8	5	25/64	5-1/8	3
3/32	2-1/4	10	1/4	4	5	13/32	5-1/4	3
7/64	2-5/8	10	17/64	4-1/8	5	27/64	5-3/8	3
1/8	2-3/4	10	9/32	4-1/4	5	7/16	5-1/2	3
9/64	2-7/8	10	19/64	4-3/8	3	29/64	5-5/8	3
5/32	3-1/8	10	5/16	4-1/2	3	15/32	5-3/4	3
11/64	3-1/4	10	21/64	4-5/8	3	31/64	5-7/8	3
3/16	3-1/2	10	11/32	4-3/4	3	1/2	6	3
13/64	3-5/8	10	23/64	4-7/8	3			

HOG RING PLIERS

HG-8



(FOR USE WITH HOG RINGS- W&E PART #1220 PG. 64)
 FLAT ANGLED NOSE, EASIER ACCESSIBILITY, EXCELLENT FOR ALL INSTALLATIONS
 INCLUDING NON-REMOVABLE CUSHIONS
 UNIT PKG.-1

PLASTIC BLIND RIVETING TOOL

PRG-30



All steel construction, pulls all W&E plastic blind rivets; full size handles provide extra long pulling stroke to set rivets quickly. Packaged in reusable vinyl pouch.
 (SEE PG. 76 FOR W&E PLASTIC RIVETS)

UNIT PKG.-1

HOSE CLAMPS

**WORM DRIVE-STAINLESS STEEL BAND
 PLATED CARBON STEEL SCREW & HOUSING**

<u>PART</u>	<u>#SIZE</u>	<u>CLAMP RANGE</u>
2564	#4	7/32" - 5/8"
2565	#6	5/16" - 7/8"
2566	#10	9/16" - 1-1/16"
2567	#12	9/16" - 1-1/4"
2568	#20	3/4" - 1-3/4"
2569	#24	1-1/16" - 2"
2570	#28	1-5/16" - 2-1/4"
2754	#32	1-9/16" - 2-1/2"
2571	#36	1-13/16" - 2-3/4"

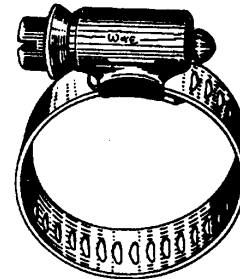

EACH NUMBER UNIT PKG.-10

WINDSHIELD REMOVAL

WK-3

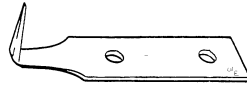

**WINDSHIELD REMOVAL BLADES
USE WITH WOODEN HANDLE KNIFE**

UNIT PKG.-6

PW-15

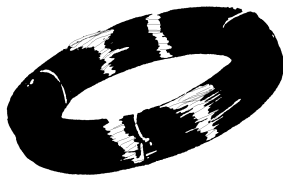

**PIANO WIRE
FOR REMOVAL OF WINDSHIELDS NOT BROKEN
1/4 LB. HANK
UNIT PKG.-1**

WW-72



**THREE STRANDED "GOLD"
WINDSHIELD WIRE
FOR CUTTING URETHANE
WINDSHIELD SEALS
72 FT. COIL
UNIT PKG.-1**

DOOR AND TRUNK WEATHERSTRIP-EPDM / NEOPRENE

30

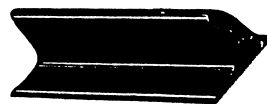

**ALL GM CARS
UNIT PKG.-50 FT. ROLL**

31

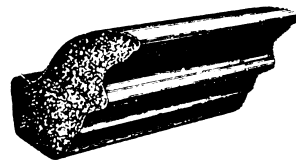

**DECK LID WEATHERSTRIP
GM CARS
UNIT PKG.-50 FT. ROLL**

6000

**ALL PURPOSE
CLAMP BRACKET**



9" long x 1 3/4" wide 3/4" grab - steel angle

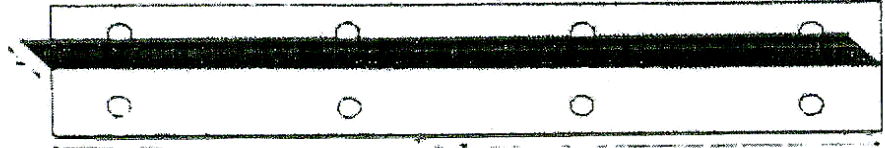

Feature 1: TIE DOWN - Especially useful where bodies do not have a pinch weld (Mercedes, etc.) or where pinch weld has been damaged..

Feature 2: BODY AND FRAME STRAIGHTENING - Especially useful on unitized bodies and areas where there are no places for clamps to grab. (front end, rear-end)

Feature 3: Part can be welded or bolted to areas to be straightened.

Feature 4: There is enough area on bracket so it can be used with all types of clamps.

UNIT PKG. - 6

BRG-1

MADE IN USA

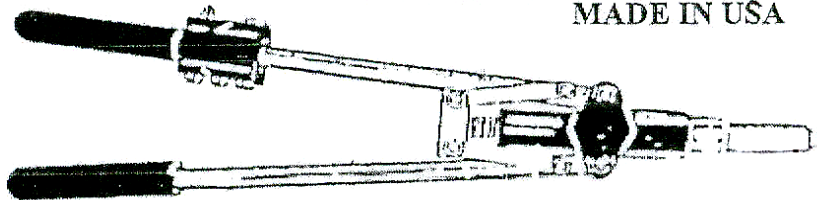

Includes eight nosepieces to install 3/32", 1/8", 5/32", 3/16", 1/4"; 3/16" & 1/4" monobolts; 1/4" window regulator rivets. See pgs. 89-92 for a complete selection of W&E rivets.

UNIT PKG.-1

STECK PULL RODS PULL ROD SET - NO. PR 200



Pull Rods eliminate removal of upholstery and cutting out inner panels. With Pull Rods, you direct your time and effort to repairing the job, not trying to get at it!

You work exclusively outside the car. This method of body repair is fast.

DRILL HOLES - - PULL OUT DAMAGE - - FILL HOLES - - and you are ready to refinish.

SET INCLUDES: 4 PULL RODS, 2 PICK PULLS, STAINLESS STEEL STRAIGHT-EDGE, 3/8" DRILL.

UNIT PKG.- 1 SET

PULL RODS

PR-200-1 PULL ROD

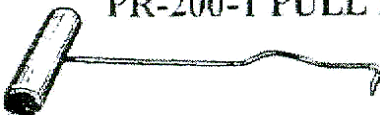

UNIT PKG.-1

PLEASE CONTACT US VIA PHONE, FAX OR EMAIL WITH ANY QUESTIONS



"METRIC CONVERSION TABLE"

Millimeter/Decimal/Fractional Equivalents

METRIC	DEC.	FRACT.	METRIC	DEC.	FRACT.	METRIC	DEC.	FRACT.
0.3968mm	.0156"	1/64"	13mm	.5118"		29mm	1.1417"	
0.7924	.0312	1/32	14	.5512		30	1.1811	
1	.0394		14.2875	.5625	9/16"	35	1.3779	
1.5875	.0625	1/16	15	.5905		38.1	1.5000	1 1/2"
2	.0787		15.8750	.625	5/8	40	1.5748	
3	.1181		16	.6299		45	1.7716	
3.175	.1250	1/8	17	.6693		50	1.9685	
4	.1575		18	.7087		50.8	2.000	2
4.7625	.1875	3/16	19	.748		55	2.1653	
5	.1968		19.05	.750	3/4	60	2.3622	
6	.2362		20	.7874		63.5	2.500	2 1/2
6.35	.2500	1/4	21	.8268		65	2.5590	
7	.2756		22	.8661		70	2.7559	
7.9375	.3125	5/16	22.23	.875	7/8	75	2.9527	
8	.3150		23	.9055		76.2	3.000	3
9	.3543		24	.9449		80	3.1496	
9.525	.375	3/8	25	.9842		85	3.3464	
10	.3937		25.4	1.0000	1	90	3.5433	
11	.4331		26	1.0236		95	3.7041	
11.1125	.4375	7/16	27	1.0630		100	3.9370	
12	.4724		28	1.1024		101.6	4.000	4
12.7	.5000	1/2						

PLEASE CONTACT US VIA PHONE, FAX
OR EMAIL WITH ANY QUESTIONS

VISIT OUR WEBSITE AT:

WWW.WESALES.COM

RB-8

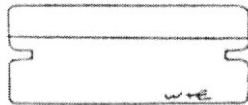

PLASTIC RAZOR BLADE
FOR USE ON PLASTIC COATED
WINDSHIELDS OR ANYWHERE
SCRATCHING BY A METAL BLADE
MIGHT BE A PROBLEM

UNIT PKG. 10

PT-217

TRIM PAD REMOVING
TOOL

Reaches under interior trim panels and lifts it without damaging the pad backboard -Long enough to reach the most recessed fastener and pries only against hidden surfaces to eliminate the danger of scratching the paint.

UNIT 1 EACH

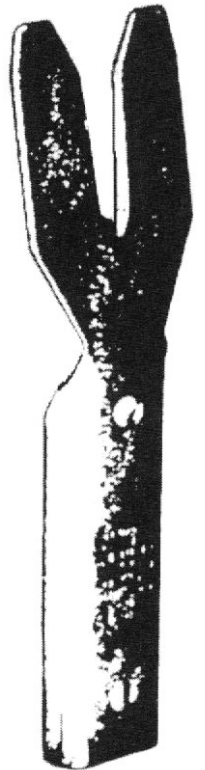

**CC-9
UNIVERSAL CAN CLIPS
PART # CC-9-100 (UNIT PKG.-100)
PART # CC-9-M (UNIT PKG.-1000)**

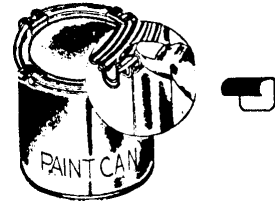

THE CC-9 UNIVERSAL CAN CLIP HAS BEEN DESIGNED TO FIT ROUND PINT, QUART AND GALLON CANS. IT MEETS POSTAL REQUIREMENTS BY LOCKING THE LID INTO POSITION FOR SHIPMENT THRU U.S. POSTAL HANDLING PROCEDURES. EASILY APPLIED WITH THUMB PRESSURE. READILY REMOVED BY A SCREWDRIVER.

PACKED 100 OR 1000 TO BOX

FLAT ACID BRUSHES



A TIN HANDLE ACID OR ADHESIVE BRUSH MADE OF THE BEST QUALITY BRISTLE AVAILABLE

<u>PART #</u>	<u>SIZE</u>	<u>BRUSH SPECS</u> <u>WIDTH</u>	<u>LENGTH</u>	<u>OVERALL</u> <u>LENGTH</u>
FA-100	#1	3/8"	3/4"	6"
FA-176	#2	1/2"	13/16"	6"
FA-300	#3	9/16"	7/8"	6"

EACH UNIT PKG.- 144 (1 GROSS)

**GM-160
DOOR HANDLE
CLIP REMOVER**



OVERALL LENGTH- 6-1/4"
GM AND FORD
GM-160 INSIDE DOOR
HANDLE REMOVER IS EASY
TO USE!
NO OTHER TOOL
REQUIRED!
NO LOST CLIP! NO CUT
FINGERS! NO SHARP
EDGES! MADE FROM
TEMPERED SPRING STEEL
UNIT PKG.-1

**SQ-2000
RUBBER SQUEEGEE**



2" X 3" X 3/16" THICK
AN ECONOMICAL EXTRUDED
SQUEEGEE SUITABLE FOR
APPLYING PUTTY, COLD
SOLDER AND FOR SANDING
OPERATIONS
PACK 100, 250 OR 500 TO A
BOX

TP-50



SUPER-ADHESIVE
1/2" DOUBLE FACED TAPE
USE TO ATTACH:
MOULDINGS, EMBLEMS, CLIPS
INTERIOR TRIM PANELS,
FASCIA STRIPS AND
MANY MORE APPLICATIONS
UNIT PKG.- 1 ROLL (54 FT.)

“METRIC CONVERSION TABLE”

Millimeter/Decimal/Fractional Equivalents

METRIC	DEC.	FRACT.	METRIC	DEC.	FRACT.	METRIC	DEC.	FRACT.
0.3968mm	.0156"	1/64"	13mm	.5118"		29mm	1.1417"	
0.7924	.0312	1/32	14	.5512		30	1.1811	
1	.0394		14.2875	.5625	9/16"	35	1.3779	
1.5875	.0625	1/16	15	.5905		38.1	1.5000	1 1/2"
2	.0787		15.8750	.625	5/8	40	1.5748	
3	.1181		16	.6299		45	1.7716	
3.175	.1250	1/8	17	.6693		50	1.9685	
4	.1575		18	.7087		50.8	2.000	2
4.7625	.1875	3/16	19	.748		55	2.1653	
5	.1968		19.05	.750	3/4	60	2.3622	
6	.2362		20	.7874		63.5	2.500	2 1/2
6.35	.2500	1/4	21	.8268		65	2.5590	
7	.2756		22	.8661		70	2.7559	
7.9375	.3125	5/16	22.23	.875	7/8	75	2.9527	
8	.3150		23	.9055		76.2	3.000	3
9	.3543		24	.9449		80	3.1496	
9.525	.375	3/8	25	.9842		85	3.3464	
10	.3937		25.4	1.0000	1	90	3.5433	
11	.4331		26	1.0236		95	3.7041	
11.1125	.4375	7/16	27	1.0630		100	3.9370	
12	.4724		28	1.1024		101.6	4.000	4
12.7	.5000	1/2						

CRT-1 W&E CLIP REMOVAL TOOL

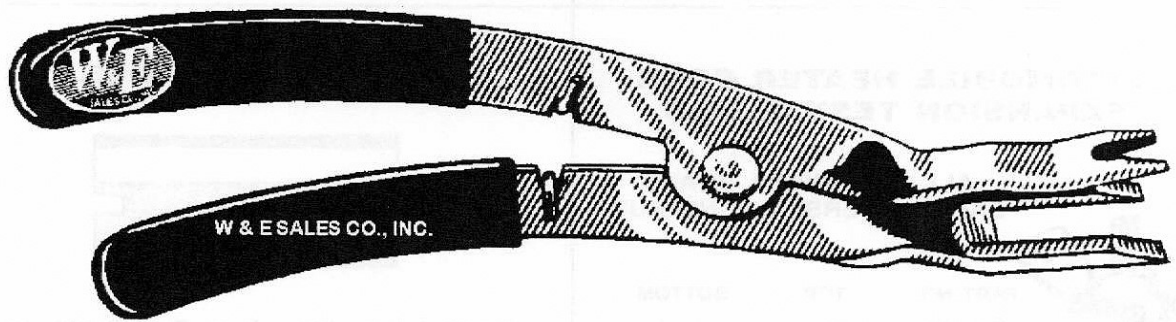

IDEAL TOOL FOR REMOVING CLIPS AND RETAINERS QUICKLY AND EASILY WITHOUT DAMAGE TO THE PANEL. SEAT THE TOOL ON THE SHAFT OF THE CLIP AND SQUEEZE THE HANDLES TOGETHER. HIGH CARBON STEEL, ZINC PLATED WITH MOLDED HANDLE GRIPS. MAKES REMOVING CLIPS AND RETAINERS AN EASIER JOB. PLEASE NOTE: ALWAYS REPLACE OLD CLIPS WITH NEW ONES WHEN RE-INSTALLING THE PANEL.

UNIT PKG.-1

EXPANSION TEST PLUGS

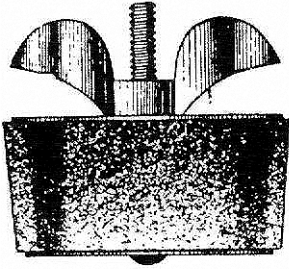

Fits irregular shaped as well as round radiator water connections. Each Expansion Plug is a completely assembled unit of live rubber, brass washers, brass screws and non corrosive wing nut.

PART NO.	TOP DIMENSION	BOTTOM DIMENSION	PIECES TO SET
EP 3	1 ⁵ / ₁₆ "	3/4"	2
EP 4	1"	7/8"	2
EP 5	1 ¹ / ₈ "	1 ⁵ / ₁₆ "	2
EP 6	1 ¹ / ₄ "	1"	1
EP 7	1 ¹ / ₂ "	1 ¹ / ₄ "	1
EP 8	1 ⁵ / ₈ "	1 ³ / ₈ "	1
EP 9	1 ¹³ / ₁₆ "	1 ¹ / ₂ "	1
EP 10	2"	1 ¹ / ₁₆ "	1
EP 11	2 ¹ / ₄ "	1 ³ / ₈ "	1
EP 12	2 ¹ / ₂ "	2 ¹ / ₄ "	1

EPS 13 – Set consists of 13 plugs.

See price sheets for packaging information.

AUTOMOBILE HEATER CORE EXPANSION TEST PLUGS

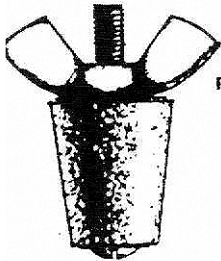

ALL HARDWARE BRASS
LARGE OVERSIZE WING NUT

PART NO.	TOP	BOTTOM
EP-00	5/8"	7/16"
EP-0	1 ¹ / ₁₆ "	1/2"

EACH UNIT PKG.-1

"METRIC CONVERSION TABLE"

Millimeter/Decimal/Fractional Equivalents

METRIC	DEC.	FRACT.	METRIC	DEC.	FRACT.	METRIC	DEC.	FRACT.
0.3968mm	.0156"	1/64"	13mm	.5118"		29mm	1.1417"	
0.7924	.0312	1/32	14	.5512		30	1.1811	
1	.0394		14.2875	.5625	9/16"	35	1.3779	
1.5875	.0625	1/16	15	.5905		38.1	1.5000	1 1/2"
2	.0787		15.8750	.625	5/8	40	1.5748	
3	.1181		16	.6299		45	1.7716	
3.175	.1250	1/8	17	.6693		50	1.9685	
4	.1575		18	.7087		50.8	2.000	2
4.7625	.1875	3/16	19	.748		55	2.1653	
5	.1968		19.05	.750	3/4	60	2.3622	
6	.2362		20	.7874		63.5	2.500	2 1/2
6.35	.2500	1/4	21	.8268		65	2.5590	
7	.2756		22	.8661		70	2.7559	
7.9375	.3125	5/16	22.23	.875	7/8	75	2.9527	
8	.3150		23	.9055		76.2	3.000	3
9	.3543		24	.9449		80	3.1496	
9.525	.375	3/8	25	.9842		85	3.3464	
10	.3937		25.4	1.0000	1	90	3.5433	
11	.4331		26	1.0236		95	3.7041	
11.1125	.4375	7/16	27	1.0630		100	3.9370	
12	.4724		28	1.1024		101.6	4.000	4
12.7	.5000	1/2						

EW-14

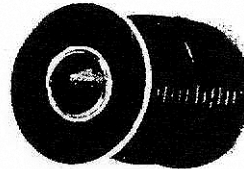

GENERAL PURPOSE
PRIMARY WIRE
Stranded Copper
SAE Standard Type
14 gauge – 100' Spool
Thermoplastic Insulated
Blue Color

UNIT PKG. – 1 Roll

RB-1 RAZOR BLADES

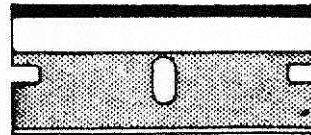

Single Edge, Heavy Duty, First Quality Industrial Blades – a Handy Tool in Any Shop.

Packed 100 to Box

DRAWER ASSORTMENTS

(STEEL BOX-13-1/4" WIDE; 9-1/4" DEEP & 2" HIGH)
(FITS IN SLIDE RACKS- #CR-4 AND CR-6)

		SD-1402					
SHEET METAL SCREW ASSORTMENT							
2389 #6 X 1" PHILLIPS PAN HEAD SHEET METAL SCREW- PLATED	2390 #8 X 3/4" PHILLIPS PAN HEAD SHEET METAL SCREW PLATED	680 #6 X 1/2" PHILLIPS PAN HEAD SHEET METAL SCREW PLATED	622 #8 X 3/8" PHILLIPS FLAT HEAD SHEET METAL SCREW PLATED	636 #8 X 1" (#6 HEAD) PHILLIPS OVAL HEAD SHEET METAL SCREW PLATED	655 #10 X 3/4" (#8 HEAD) PHILLIPS OVAL HEAD SHEET METAL SCREW PLATED		
627 #6 X 1" PHILLIPS OVAL HEAD SHEET METAL SCREW-PLATED	689 #10 X 1" PHILLIPS PAN HEAD SHEET METAL SCREW PLATED	682 #8 X 1/2" PHILLIPS PAN HEAD SHEET METAL SCREW PLATED	633 #8 X 5/8" (#6 HEAD) PHILLIPS OVAL HEAD SHEET METAL SCREW PLATED	637 #8 X 1" PHILLIPS OVAL HEAD SHEET METAL SCREW PLATED	658 #10 X 1" (#6 HEAD) PHILLIPS OVAL HEAD SHEET METAL SCREW		
631 #8 X 1/2" PHILLIPS OVAL HEAD SHEET METAL SCREW-PLATED	2393 #12x 3/4" PHILLIPS PAN HEAD SHEET METAL SCREW PLATED	684 #10 X 1/2" PHILLIPS PAN HEAD SHEET METAL SCREW PLATED	635 #8 X 3/4" PHILLIPS OVAL HEAD SHEET METAL SCREW PLATED	640 #8X 1-1/2" (#6 HEAD) PHILLIPS OVAL HEAD SHEET METAL SCREW PLATED	660 #10 X 1-1/2" (#6 HEAD) PHILLIPS OVAL HEAD SHEET METAL SCREW PLATED		
2396 #14 X 3/4" PHILLIPS PAN HEAD SHEET METAL SCREW-PLATED	537 #14 X 3/4" SLOTTED PAN HEAD SHEET METAL SCREW-PLATED	686 #10 X 3/4" PHILLIPS PAN HEAD SHEET METAL SCREW PLATED	2498 #8 X 3/4" (#6 HEAD) PHILLIPS OVAL HEAD SHEET METAL SCREW PLATED	641 #8 X 1-3/4" (#6 HEAD) PHILLIPS OVAL HEAD SHEET METAL SCREW PLATED	2391 #10 X 1-1/2" (#8 HEAD) PHILLIPS PAN HEAD SHEET METAL SCREW PLATED		

























		SD-1403					
UNIVERSAL MOULDING CLIP & PANEL CLIP ASSORTMENT							
1222 RETAINER- HOOD TO COWL- GM & FORD	1036 FINISHING WASHERS COUNTERSUNK #6 SCREW SIZE	2402 WIRE MOULDING CLIP 3/4" MOULDINGS	2254 SIDE & TAILGATE MOULDING CLIP	2109 ROCKER PANEL MOULDING CLIP	156 MOULDING BOLT		
1213 DOOR TRIM PANEL FASTENER- FORD & GM	633 #6 X 5/8" (#6 HEAD) PHILLIPS OVAL HEAD SHEET METAL	332 SIDE MOULDING CLIP 7/16" X 9/16"	1210 DOOR PANEL CLIP REGULAR THROAT	146 MOULDING BOLT 10-24 X 3/4"	147 MOULDING BOLT 10-24 X 3/4"		
1205 DOOR TRIM PANEL FASTENER- GM	1262 INSIDE DOOR HANDLE RETAINING CLIP	333 SIDE MOULDING CLIP 1/2" X 11/16"	336 SIDE MOULDING CLIP 7/8" X 1"	150 MOULDING BOLT 10-24 X 3/4"	161 MOULDING BOLT 10-24 X 3/4"		
777 10-24 HEX NUT USE WITH MOULDING BOLTS	1223 TRIM & PANEL CLIP UPPER GRILLE	175 PUSH-IN (BLIND) MOULDING CLIP 13/16" X 3/8"	2108 RETAINER-FILLER BETWEEN BUMPER & FENDER	1225 PLASTIC SCREW NAIL RETAINER-UNIVERSAL	161 MOULDING BOLT 10-24 X 3/4"		

DRAWER ASSORTMENTS
 (STEEL BOX-13-1/4" WIDE; 9-1/4" DEEP & 2" HIGH)
 (FITS IN SLIDE RACKS- #CR-4 AND CR-6)



SD-1404
CLIPS NUTS, PUSH ON CLIPS & TUBULAR CLIP ASSORTMENT



























885  PUSH ON CLIPS 1/16" STUD	889  PUSH ON CLIPS 3/16" STUD	876  TUBULAR CLIPS 1/8" STUD	852  CLIP NUT #8 SCREW SIZE	814  CLIP NUT #14 SCREW SIZE	860  CLIP NUT #14 SCREW SIZE
886  PUSH ON CLIPS 3/32" STUD	890  PUSH ON CLIPS 1/4" STUD	874  TUBULAR CLIPS 3/32" STUD	853  CLIP NUT #8 SCREW SIZE	855  CLIP NUT #10 SCREW SIZE	861  LICENSE PLATE CLIP NUT
887  PUSH ON CLIPS 1/8" STUD	879  TUBULAR CLIPS 3/16" STUD (#10 THREAD)	878  TUBULAR CLIPS 3/16" STUD	2346  CLIP NUT	859  CLIP NUT	2255  CLIP NUT -LONG THROAT #8 SCREW SIZE
888  PUSH ON CLIPS 3/32" STUD	875  TUBULAR CLIPS 1/8" STUD	881  TUBULAR CLIPS 3/16" STUD FOR 1/4" HOLE	858  CLIP NUT #10 SCREW SIZE	811  CLIP NUT #8 SCREW SIZE	2164  CLIP NUT #10 SCREW SIZE

























SD-1406
METRIC BOLT AND NUT ASSORTMENT



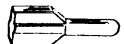











5004  4 X .7 MM HEX NUT DIN 934	5010  10 X 1.5 MM HEX NUT DIN 934	5502  5MM X 20MM CAP SCREW DIN 933	5603  6MM X 25MM CAP SCREW DIN 933	5803  8MM X 25MM CAP SCREW DIN 933	5102  10MM X 20 MM CAP SCREW DIN 933
5005  5 X .8 MM HEX NUT DIN 934	5401  4MM X 16MM CAP SCREW DIN 933	5503  5MM X 25MM CAP SCREW DIN 933	5604  6MM X 30MM CAP SCREW DIN 933	5804  8MM X 30 MM CAP SCREW DIN 933	5103  10MM X 30MM CAP SCREW DIN 933
5006  6 X 1 MM HEX NUT DIN 934	5402  4MM X 20MM CAP SCREW DIN 933	5601  6MM X 16MM CAP SCREW DIN 933	5801  8MM X 16MM CAP SCREW DIN 933	5805  8MM X 35MM CAP SCREW DIN 933	5104  10MM X 30MM CAP SCREW DIN 933
5008  8 X 1.25 MM HEX NUT DIN 934	5501  5MM X 16MM CAP SCREW DIN 933	5602  6MM X 20MM CAP SCREW DIN 933	5802  8MM X 20MM CAP SCREW DIN 933	5806  8MM X 40MM CAP SCREW DIN 933	5106  10MM X 40MM CAP SCREW DIN 933



DRAWER ASSORTMENTS
(STEEL BOX-13-1/4" WIDE; 9-1/4" DEEP & 2" HIGH)
(FITS IN SLIDE RACKS- #CR-4 AND CR-6)

		SD-1407 SOLDERLESS TERMINALS ASSORTMENT					
<p>421</p>  <p>RING TONGUES 22-16 WIRE #8-10 STUD SIZE</p>	<p>427</p>  <p>RING TONGUES 12-10 WIRE #8-10 STUD SIZE</p>	<p>432</p>  <p>SPADE TONGUES #12-10 WIRE</p>	<p>440</p>  <p>BUTT CONNECTORS (NYLON) #22-16 WIRE</p>	<p>444</p>  <p>DEAD END CONNECTOR (NYLON)</p>	<p>449</p>  <p>SNAP PLUG #16-14 WIRE (USE WITH W&E #448)</p>		
<p>424</p>  <p>RING TONGUES 16-14 WIRE #8-10 STUD SIZE</p>	<p>428</p>  <p>RING TONGUES 12-10 WIRE</p>	<p>433</p>  <p>SPADE TONGUES #12-10 WIRE</p>	<p>441</p>  <p>BUTT CONNECTORS (NYLON) #16-14 WIRE</p>	<p>445</p>  <p>FEMALE QUICK DISCONNECT #16-14 WIRE (COLOR-BLUE)</p>	<p>450</p>  <p>QUICK ELECTRIC CONNECTOR- SELF STRIPPING</p>		
<p>425</p>  <p>RING TONGUES 16-14 WIRE #12-1/4" STUD SIZE</p>	<p>429</p>  <p>RING TONGUES 12-10 WIRE #12-1/2" STUD SIZE</p>	<p>434</p>  <p>SPADE TONGUES #12-10 WIRE #8-10 STUD SIZE</p>	<p>442</p>  <p>BUTT CONNECTORS (NYLON) #12-10 WIRE (COLOR-YELLOW)</p>	<p>446</p>  <p>MALE QUICK DISCONNECT #16-14 WIRE (COLOR-BLUE)</p>	<p>454</p>  <p>FULLY INSULATED FEMALE QUICK DISCONNECT #16-14 WIRE (COLOR-BLUE)</p>		
<p>426</p>  <p>RING TONGUES 16-14 WIRE 5/16"-3/8" STUD SIZE</p>	<p>430</p>  <p>RING TONGUES 12-10 WIRE</p>	<p>437</p>  <p>HOOK TONGUES #16-14 WIRE</p>	<p>443</p>  <p>DEAD END CONNECTOR (NYLON) #22-14 WIRE</p>	<p>448</p>  <p>STOP LIGHT CONNECTOR #16-14 WIRE</p>	<p>2576</p>  <p>FULLY INSULATED MALE QUICK DISCONNECT #16-14 WIRE (COLOR-BLUE)</p>		

		SD-1455 BLIND RIVET SHOP DISPENSER				
<p>1250 (ABA 4-3)</p>  <p>ALUMINUM SMALL FLANGE PANEL RIVET 1/8" DIAMETER PANEL RANGE UP TO 3/16"</p>	<p>2133 (SBS 5-6)</p>  <p>STEEL DOME HEAD RIVET 5/32" DIAMETER 1/4" TO 3/8" PANEL RANGE</p>	<p>2138 (ABA 6-4)</p>  <p>ALUMINUM DOME HEAD RIVET 3/16" DIAMETER</p>				
<p>2130 (SBS 4-2)</p>  <p>STEEL DOME HEAD RIVET 1/8" DIAMETER</p>	<p>2134 (SCS 4-2)</p>  <p>STEEL COUNTERSUNK HEAD RIVET 1/8" DIAMETER</p>	<p>2139 (ABA 6-6)</p>  <p>ALUMINUM DOME HEAD RIVET 3/16" DIAMETER</p>				
<p>2131 (SBS 4-4)</p>  <p>STEEL DOME HEAD RIVET 1/8" DIAMETER 1/8" TO 1/4" PANEL RANGE</p>	<p>2135 (SCS 4-4)</p>  <p>STEEL COUNTERSUNK HEAD RIVET 1/8" DIAMETER 1/8" TO 1/4" PANEL RANGE</p>	<p>2162 (ABA 66L)</p>  <p>LARGE FLANGE ALUMINUM RIVET</p>				
<p>2132 (SBS 4-6)</p>  <p>STEEL DOME HEAD RIVET 1/8" DIAMETER</p>	<p>2137 (ABA 6-2)</p>  <p>ALUMINUM DOME HEAD RIVET 3/16" DIAMETER UP TO 18" PANEL RANGE</p>	<p>2263 (ABA 610L)</p>  <p>LARGE FLANGE ALUMINUM RIVET 3/16" DIAM., 1/2" TO 5/8" PANEL RANGE</p>				

DRAWER ASSORTMENTS
 (STEEL BOX-13-1/4" WIDE; 9-1/4" DEEP & 2" HIGH)
 (FITS IN SLIDE RACKS- #CR-4 AND CR-6)



SD-1465
PLASTIC PUSH-IN FASTENER & RIVET
ASSORTMENT



























<p>1205</p>  <p>DOOR TRIM PANEL RETAINER GM, CHRYSLER & FORD</p>	<p>1206</p>  <p>DOOR WEATHERSTRIP CLIP GM, FORD & UNIVERSAL</p>	<p>1222</p>  <p>HOOD INSULATION/ SPLASH SHIELD CLIP- GM & FORD</p>	<p>1223</p>  <p>TRIM AND PANEL RETAINER CHRYSLER & UNIVERSAL</p>	<p>1224</p>  <p>HOOD INSULATION CLIP FORD & CHRYSLER</p>	<p>1227</p>  <p>HOOD INSULATION CLIP GM AND UNIVERSAL</p>
<p>1225</p>  <p>BLACK SCREW NAIL RETAINER GM, AMC & UNIVERSAL</p>	<p>2279</p>  <p>GREY SCREW NAIL RETAINER GM, AMC & UNIVERSAL</p>	<p>2104</p>  <p>GRILLE RIVET FORD AND UNIVERSAL</p>	<p>2105</p>  <p>TRIM PANEL RETAINER GM, FORD & CHRYSLER</p>	<p>2107</p>  <p>TRIM RETAINER GM AND UNIVERSAL</p>	<p>1227</p>  <p>HOOD INSULATION CLIP GM AND UNIVERSAL</p>
<p>2108</p>  <p>FENDER AND BUMPER RETAINER GM&UNIVERSAL</p>	<p>2117</p>  <p>TRIM PANEL FASTENER GM & FORD</p>	<p>2140</p>  <p>SCREW NAIL RETAINER GM, FORD, CHRYSLER, AMC</p>	<p>2462</p>  <p>DOOR PANEL FASTENER GM- '82 & UP</p>	<p>2223</p>  <p>PLASTIC RIVET BUMPER STRIP GM- '81 & UP</p>	<p>2230</p>  <p>HOOD INSULATION CLIP-GM</p>
<p>2190</p>  <p>DOOR TRIM RETAINER CHRYSLER PRODUCTS</p>	<p>2204</p>  <p>PANEL FASTENER GM</p>	<p>2512</p>  <p>DOOR PANEL CLIP BUMPER STRIP GM</p>	<p>2207</p>  <p>WEATHERSTRIP CLIP GM & UNIVERSAL</p>	<p>2216</p>  <p>MUD SKIRT RETAINER AMC, FORD, GM CHRYSLER</p>	<p>2230</p>  <p>HOOD INSULATION CLIP-GM</p>















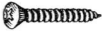

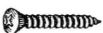



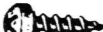



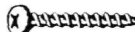

SD-1466
USS BOLT AND NUT ASSORTMENT



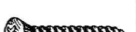

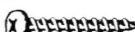









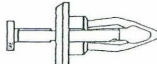

<p>4001</p>  <p>1/4"-20 HEX NUT ZINC PLATED</p>	<p>4005</p>  <p>1/2"-13 HEX NUT ZINC PLATED</p>	<p>4104</p>  <p>1/4 X 1-1/4" CAP SCREW ZINC PLATED</p>	<p>4113</p>  <p>5/16 X 1" CAP SCREW GRADE 5- ZINC</p>	<p>4117</p>  <p>5/16 X 2" CAP SCREW GRADE 5- ZINC</p>	<p>4127</p>  <p>3/8 X 2" CAP SCREW GRADE 5- ZINC</p>
<p>4002</p>  <p>5/16"-18 HEX NUT ZINC PLATED</p>	<p>4101</p>  <p>1/4 X 1/2" CAP SCREW GRADE 5- ZINC</p>	<p>4105</p>  <p>1/4 X 1-1/2" CAP SCREW GRADE 5- ZINC</p>	<p>4115</p>  <p>5/16 X 1-1/2" CAP SCREW GRADE 5- ZINC</p>	<p>4133</p>  <p>7/16 X 1" CAP SCREW GRADE 5- ZINC</p>	<p>4137</p>  <p>7/16 X 2" CAP SCREW GRADE 5- ZINC</p>
<p>4003</p>  <p>3/8"-16 HEX NUT ZINC PLATED</p>	<p>4102</p>  <p>1/4 X 3/4" CAP SCREW GRADE 5- ZINC</p>	<p>4107</p>  <p>1/4 X 2" CAP SCREW GRADE 5- ZINC</p>	<p>4123</p>  <p>3/8 X 1-1/2" CAP SCREW GRADE 5- ZINC</p>	<p>4135</p>  <p>7/16 X 1-1/2" CAP SCREW GRADE 5- ZINC</p>	<p>4147</p>  <p>1/2 X 2" CAP SCREW GRADE 5- ZINC</p>
<p>4004</p>  <p>7/16"-14 HEX NUT ZINC PLATED</p>	<p>4103</p>  <p>1/4 X 1" CAP SCREW GRADE 5- ZINC</p>	<p>4112</p>  <p>5/16 X 3/4" CAP SCREW GRADE 5- ZINC</p>	<p>4125</p>  <p>3/8 X 1-1/2" CAP SCREW GRADE 5- ZINC</p>	<p>4145</p>  <p>1/2 X 1-1/2" CAP SCREW GRADE 5- ZINC</p>	<p>4149</p>  <p>1/2 X 2-1/2" CAP SCREW GRADE 5- ZINC</p>



DRAWER ASSORTMENTS
 (STEEL BOX-13-1/4" WIDE; 9-1/4" DEEP & 2" HIGH)
 (FITS IN SLIDE RACKS- #CR-4 AND CR-6)

		SD-1467 BLACK SHEET METAL SCREW ASSORTMENT					
673  #8 X 1/2" PHILLIPS OVAL HEAD SHEET METAL SCREW BLACK OXIDE PLATED	2148  #8 X 1/2" PHILLIPS PAN HEAD SHEET METAL SCREW BLACK	2331  #8 X 1/2" PHILLIPS OVAL HEAD SHEET METAL SCREW BLACK OXIDE PLATED	2225  4.2 X 10 MM PHILLIPS FLAT WASHER HEAD SHEET METAL SCREW	2193  4.2 X 20 MM INDENTED HEX HD SHEET METAL SCREW-W/ LOOSE WSHR BLACK	2296  #8X3/4"PHILLIPS OVAL FINISHING SEMS COUNTERSUNK WASHER		
674  #8 X 3/4" #6 HD. PHILLIPS OVAL HEAD SHEET METAL SCREW BLACK OXIDE PLATED	2149  #10 X 1" PHILLIPS PAN HEAD SHEET METAL SCREW BLACK	2332  #8 X 3/4" PHILLIPS OVAL HEAD SHEET METAL SCREW BLACK OXIDE PLATED	2226  4.2 X 20 MM PHILLIPS FLAT WASHER HEAD SHEET METAL SCREW BLACK	3316  4.2 X 13 MM PHILLIPS PAN HD-SCREW-AB W/ 12 MM FREE SPINNING WASHER BLACK	2297  #8 X 1" PHILLIPS OVAL FINISHING SEMS COUNTERSUNK WASHER BLACK		
675  #8 X 1" #6 HD PHILLIPS OVAL HEAD SHEET METAL SCREW BLACK OXIDE PLATED	2319  #8 X 3/4" PHILLIPS PAN HEAD SHEET METAL SCREW BLACK	2333  #8 X 1" PHILLIPS OVAL HEAD SHEET METAL SCREW BLACK OXIDE PLATED	2227  4.2 X 13 MM PHILLIPS ROUND WASHER HEAD SHEET METAL SCREW BLACK	2322  4.2 X 20 MM HEX HEAD SHEET METAL SCREW-WITH LOOSE WASHER BLACK	2335  #10 X 3/4" PHILLIPS OVAL HEAD SHEET METAL SCREW BLACK OXIDE PLATED		
676  #8 X 1-1/4" #6 HD. PHILLIPS OVAL HEAD SHEET METAL SCREW BLACK OXIDE PLATED	2320  #8X 1" PHILLIPS PAN HEAD SHEET METAL SCREW BLACK	2334  #8 X 1-1/4" PHILLIPS OVAL HEAD SHEET METAL SCREW BLACK OXIDE PLATED	2345  #8 X 3/4" PHILLIPS ROUND WASHER HEAD SHEET METAL SCREW BLACK	2340  4.2 X 13 MM PHILLIPS FLAT WASHER HEAD SELF DRILLING SCREW BLACK	2325  4.2 X 10 MM PHILLIPS ROUND WASHER HEAD SHEET METAL SCREW BLACK		



















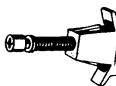

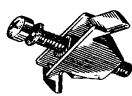

		SD-1470 PLASTIC DRIVE RIVET ASSORTMENT			
2216  FRONT FENDER MUD SKIRT ATTACHING-GM	2388  BUMPER FASCIA/ GENERAL USE GM, FORD	2437  BUMPER FASCIA GENERAL USE-GM			
2223  FRONT & REAR BUMPER ATTACHING STRIP (BLACK) - GM	2398  PLASTIC DRIVE RIVET- (6.3 MM HOLE) GM, FORD, AMC & CHRYSLER	2438  BUMPER FASCIA GENERAL USE-GM			
2550  NYLON PUSH RIVET- (8 MM HOLE) GM, C,K TRUCK, FORD & CHRYSLER	2399  PLASTIC DRIVE RIVET- (8 MM HOLE) GM, FORD & CHRYSLER	2453  FASCIA RETAINER (8MM HOLE) GM & CHRYSLER			
2974  PLASTIC DRIVE RIVET- BUMPER FASCIA- GM	2420  PUSH TYPE RIVET- (8 MM HOLE) GM, FORD	2458  SPLASH SHIELD, FASCIA RETAINER (6 MM HOLE) FORD & CHRYSLER			

DRAWER ASSORTMENTS
 (STEEL BOX-13-1/4" WIDE; 9-1/4" DEEP & 2" HIGH)
 (FITS IN SLIDE RACKS- #CR-4 AND CR-6)

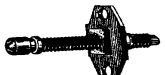

SD-2100
HEADLAMP PARTS
ASSORTMENT



























<p>2248</p>  <p>HEADLAMP ADJUSTING NUT- TOYOTA</p>	<p>2124</p>  <p>HEADLAMP ADJUSTING NUT-GM</p>	<p>1010</p>  <p>HEADLAMP ADJUSTING ASSEMBLY-CHRYSLER</p>	<p>1041</p>  <p>HEADLAMP ADJUSTING SCREW- 12-28 X 1-3/4"</p>	<p>2700</p>  <p>HEADLAMP RETAINER FORD RANGER-</p>	<p>2235</p>  <p>HEADLAMP ADJUSTING ASSEMBLY- FORD</p>
<p>835</p>  <p>HEADLAMP ADJUSTING ASSEMBLY- CHRYSLER</p>	<p>1034</p>  <p>HEADLAMP ADJUSTING ASSEMBLY-GM</p>	<p>1055</p>  <p>HEADLAMP ADJUSTING ASSEMBLY- GM</p>	<p>2118</p>  <p>HEADLAMP ADJUSTING ASSEMBLY- FORD</p>	<p>2534</p>  <p>HEADLAMP RETAINER TAURUS, SABLE, T-BIRD- TEMPO/TOPAZ</p>	<p>840</p>  <p>HEADLAMP ADJUSTING RING BEARING- FORD</p>
<p>837</p>  <p>HEADLAMP ADJUSTING NUT- GM</p>	<p>2268</p>  <p>HEADLAMP ADJUSTING ASSEMBLY-CHRYSLER</p>	<p>1013</p>  <p>HEADLAMP ADJUSTING ASSEMBLY-CHRYSLER</p>	<p>2212</p>  <p>HEADLAMP ADJUSTING NUT- NISSAN, TOYOTA</p>	<p>1024</p>  <p>HEADLAMP SPRING GM</p>	<p>1040</p>  <p>HEADLAMP ADJUSTING SCREW- 1/4-28 X 2"</p>
<p>839</p>  <p>HEADLAMP ADJUSTING NUT-GM</p>	<p>1025</p>  <p>HEADLAMP ADJUSTING ASSEMBLY-FORD</p>	<p>1012</p>  <p>HEADLAMP ADJUSTING ASSEMBLY-CADILLAC</p>	<p>2211</p>  <p>HEADLAMP ADJUSTING SCREW-NISSAN, TOYOTA</p>	<p>2244</p>  <p>HEADLAMP BEZEL NUT NATURAL COLOR- GM</p>	<p>1011</p>  <p>HEADLAMP ADJUSTING ASSEMBLY- GM</p>



1725
SHEET METAL SCREW ASSORTMENT



<p>2389</p>  <p>#6 X 1" PHILLIPS PAN HEAD SHEET METAL SCREW- PLATED</p>	<p>2390</p>  <p>#8 X 3/4" PHILLIPS PAN HEAD SHEET METAL SCREW PLATED</p>	<p>680</p>  <p>#6 X 1/2" PHILLIPS PAN HEAD SHEET METAL SCREW PLATED</p>	<p>622</p>  <p>#8 X 3/8" PHILLIPS FLAT HEAD SHEET METAL SCREW PLATED</p>	<p>636</p>  <p>#8 X 1" (#6 HEAD) PHILLIPS OVAL HEAD SHEET METAL SCREW PLATED</p>	<p>655</p>  <p>#10 X 3/4" (#8 HEAD) PHILLIPS OVAL HEAD SHEET METAL SCREW PLATED</p>
<p>627</p>  <p>#6 X 1" PHILLIPS OVAL HEAD SHEET METAL SCREW-PLATED</p>	<p>689</p>  <p>#10 X 1" PHILLIPS PAN HEAD SHEET METAL SCREW PLATED</p>	<p>682</p>  <p>#8 X 1/2" PHILLIPS PAN HEAD SHEET METAL SCREW PLATED</p>	<p>633</p>  <p>#8 X 5/8" (#6 HEAD) PHILLIPS OVAL HEAD SHEET METAL SCREW PLATED</p>	<p>637</p>  <p>#8 X 1" PHILLIPS OVAL HEAD SHEET METAL SCREW PLATED</p>	<p>658</p>  <p>#10 X 1" (#6 HEAD) PHILLIPS OVAL HEAD SHEET METAL SCREW PLATED</p>
<p>631</p>  <p>#8 X 1/2" PHILLIPS OVAL HEAD SHEET METAL SCREW-PLATED</p>	<p>2393</p>  <p>#12x 3/4" PHILLIPS PAN HEAD SHEET METAL SCREW PLATED</p>	<p>684</p>  <p>#10 X 1/2" PHILLIPS PAN HEAD SHEET METAL SCREW PLATED</p>	<p>635</p>  <p>#8 X 3/4" PHILLIPS OVAL HEAD SHEET METAL SCREW PLATED</p>	<p>640</p>  <p>#8 X 1-1/2" (#6 HEAD) PHILLIPS OVAL HEAD SHEET METAL SCREW PLATED</p>	<p>660</p>  <p>#10 X 1-1/2" (#6 HEAD) PHILLIPS OVAL HEAD SHEET METAL SCREW PLATED</p>
<p>2396</p>  <p>#14 X 3/4" PHILLIPS PAN HEAD SHEET METAL SCREW-PLATED</p>	<p>537</p>  <p>#14 X 3/4" SLOTTED PAN HEAD SHEET METAL SCREW-PLATED</p>	<p>686</p>  <p>#10 X 3/4" PHILLIPS PAN HEAD SHEET METAL SCREW PLATED</p>	<p>2498</p>  <p>#8 X 3/4" (#6 HEAD) PHILLIPS OVAL HEAD SHEET METAL SCREW PLATED</p>	<p>641</p>  <p>#8 X 1-3/4" (#6 HEAD) PHILLIPS OVAL HEAD SHEET METAL SCREW PLATED</p>	<p>2391</p>  <p>#10 X 1-1/2" (#8 HEAD) PHILLIPS PAN HEAD SHEET METAL SCREW PLATED</p>











DRAWER ASSORTMENTS
 (STEEL BOX-13-1/4" WIDE; 9-1/4" DEEP & 2" HIGH)
 (FITS IN SLIDE RACKS- #CR-4 AND CR-6)

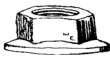
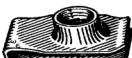

SD-5900
METRIC BOLT AND NUT ASSORTMENT

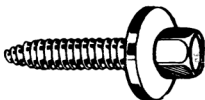

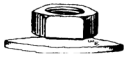
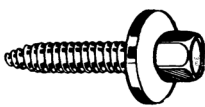











<p>5920</p>  <p>6 MM FOLDOVER NUT GM & UNIVERSAL</p>	<p>5923</p>  <p>6 MM X 20 MM BODY BOLT- WITH 17MM LOOSE WASHER, CA POINT GM AND UNIVERSAL</p>	<p>5909</p>  <p>10 MM FLANGE NUT (21 MM FLANGE DIAMETER) GM & UNIVERSAL</p>
<p>5902</p>  <p>8MM FOLDOVER NUT GM & UNIVERSAL- '77 AND UP</p>	<p>5906</p>  <p>8MM X 25MM HEX WASHER HEAD BODY BOLT- CA POINT GM AND UNIVERSAL- '77 AND UP</p>	<p>5910</p>  <p>8MM X 30MM BODY BOLT GM AND UNIVERERSAL- '77 AND UP</p>
<p>5903</p>  <p>8MM LONG THROAT FOLDOVER NUT GM&UNIVERSAL- '77 AND UP</p>	<p>5922</p>  <p>6MM HEX NUT WITH FREE SPINNING 16MM WASHER GM AND UNIVERSAL</p>	<p>5911</p>  <p>10 MM X 40 MM BODY BOLT GM-& UNIVERSAL '77 & UP</p>
<p>5904</p>  <p>10 MM FOLDOVER NUT GM AND UNIVERSAL - '77 & UP</p>	<p>5908</p>  <p>8MM HEX NUT WITH FREE SPINNING WASHER GM AND UNIVERSAL- '77 AND UP</p>	<p>5911</p>  <p>10 MM X 40 MM BODY BOLT GM-& UNIVERSAL '77 & UP</p>

PLASTIC DISPENSER ASSORTMENTS

















WSC-240
WEATHERSTRIP CLIP ASSORTMENT















<p>1206</p>  <p>WEATHERSTRIP RETAINER \- PLASTIC NAIL FASTENER 3/16" HOLE GM & UNIVERSAL</p>	<p>2207</p>  <p>WEATHERSTRIP RETAINER \- GENERAL USE 3/16" HOLE GM & UNIVERSAL</p>	<p>2379</p>  <p>WEATHERSTRIP RETAINER \- TRIM PANEL CLIP 5 MM HOLE NISSAN, TOYOTA & HONDA</p>	<p>2414</p>  <p>WEATHERSTRIP RETAINER \- PANEL RETAINER GM, FORD & AMC</p>	<p>2618</p>  <p>WEATHERSTRIP RETAINER 5 MM HOLE HONDA, NISSAN</p>	<p>2628</p>  <p>WEATHERSTRIP RETAINER GM (SATURN) CHRYSLER</p>
<p>2652</p>  <p>WEATHERSTRIP RETAINER 5 MM HOLE GM & CHRYSLER</p>	<p>2759</p>  <p>WEATHERSTRIP RETAINER CHEVY, BUICK, PONTIAC & OLDS.</p>	<p>2933</p>  <p>WEATHERSTRIP RETAINER 5 MM HOLE LINCOLN/FORD</p>	<p>2844</p>  <p>WEATHERSTRIP RETAINER 5 MM HOLE FORD & HONDA</p>	<p>2845</p>  <p>WEATHERSTRIP RETAINER 5.5 MM HOLE GM</p>	<p>2848</p>  <p>WEATHERSTRIP RETAINER 5 MM HOLE GM & CHRYSLER</p>

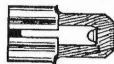

PLASTIC DISPENSER ASSORTMENTS
(PLASTIC BOX-11" X 6-3/4" X 1-3/4")

 HST-65 HEAT SHRINK TERMINAL ASSORTMENT 					
2811  HEAT SHRINK BUTT CONNECTOR 22-18 WIRE SIZE RED	2812  HEAT SHRINK BUTT CONNECTOR 16-14 WIRE SIZE BLUE	2812  HEAT SHRINK BUTT CONNECTOR 16-14 WIRE SIZE BLUE	2813  HEAT SHRINK BUTT CONNECTOR 12-10 WIRE SIZE YELLOW	2814  FULLY INSULATED QUICK CONNECT (FEMALE) 22-18 WIRE SIZE RED	2815  FULLY INSULATED QUICK CONNECT (MALE) 22-18 WIRE SIZE RED
2816  FULLY INSULATED QUICK CONNECT (FEMALE) 16-14 WIRE SIZE BLUE	2817  FULLY INSULATED QUICK CONNECT (MALE) 16-14 WIRE SIZE BLUE	2818  FULLY INSULATED QUICK CONNECT (FEMALE) 12-10 WIRE SIZE YELLOW	2819  FULLY INSULATED QUICK CONNECT (MALE) 12-10 WIRE SIZE YELLOW	2820  SNAP PLUG (MALE) 16-14 WIRE SIZE BLUE	2821  SNAP PLUG (FEMALE) 16-14 WIRE SIZE BLUE

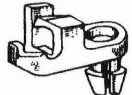
 CRA-500 DOOR LOCK ROD END CLIP ASSORTMENT 					
2505  RIGHT HAND CHRYSLER	2506  LEFT HAND CHRYSLER	2507  LEFT HAND CHRYSLER, FORD, GM & AMC	2508  RIGHT HAND CHRYSLER FORD & AMC	2509  RIGHT HAND CHRYSLER GM	3335  DOOR LOCK ROD END CLIP TOYOTA/LEXUS
2625  RIGHT HAND CHRYSLER GM	2273  METAL DOOR LOCK CLIP GM GENERAL USE	2538  BUICK, CADILLAC OLDSMOBILE, PONTIAC & SATURN	2941  RIGHT & LEFT HAND-CHEVY S & T, S-10 PICKUP	2951  DOOR & TAIL GATE LOCKS GM, FORD & FORD TRUCKS	3012  GM, CHEVY VANS TRUCKS

PLASTIC DISPENSER ASSORTMENTS

(PLASTIC BOX-11" x 6-3/4" x 1-3/4")

TCN-400 THREAD CUTTING NUT ASSORTMENT					
920 1/8" STUD 17/32" FLANGE	5990 1/8" STUD 35/64" FLANGE	923 5/32" STUD 9/16" FLANGE	921 3/16" STUD 9/16" FLANGE	922 1/4" STUD 19/32" FLANGE	2562 1/4" STUD 11/16" FLANGE
5990 3.2 MM STUD 14 MM FLANGE	5913 4 MM STUD 15 MM FLANGE	5914 5 MM STUD 15 MM FLANGE	3184 5 MM THREAD 14 MM FLANGE	2790 6 MM THREAD 18 MM FLANGE	5946 REPLACES #928 8 MM STUD 20 MM FLANGE

CLN-340 CLIP NUT ASSORTMENT					
2346 "U" TYPE #6 SCREW	852 "U" TYPE #8A SCREW	853 "J" TYPE #8A SCREW	811 "U" TYPE #8 SCREW	846 "U" TYPE #8A SCREW	2255 "U" TYPE LONG THROAT #8A OR 4.2 SCREW
2164 "U" TYPE WIDE PANEL #10A SCREW	858 "U" TYPE #10A SCREW	859 "U" TYPE #10A SCREW	814 "U" TYPE #14 SCREW	2708 "U" TYPE WIDE PANEL #14 SCREW	860 "J" TYPE #14A (1/4") SCREW

PRT-70 PLASTIC RETAINER CLIP AND TOOL ASSORTMENT					
CRT-1-CLIP REMOVAL TOOL 					
2140 SCREW NAIL RETAINER- YOKE SHIELD TO SUPPORT MOULDING, FENDERS, ETC. 1/4" HOLE LONGER THAN #1225 GM, CHRYSLER, FORD, AMC	2204 PANEL FASTENER- RADIATOR SKIRT ATTACHING CADILLAC & GM	2347 INTERIOR TRIM CLIP- BLACK 7MM HOLE; 20MM HEAD 30MM GRIP RANGE GM, FORD & UNIVERSAL	2356 BUMPER FASCIA RETAINER 10MM HOLE; 28MM STEM 21MM HEAD DIAMETER GM, FORD, AMC, CHRYSLER '85 & UP	2274 DOOR PANEL FASTENER PLASTIC, GM- '83 & UP	2224 DOOR TRIM TO INNER PANEL FASTENER GM - '77 TO '82













PLASTIC DISPENSER ASSORTMENTS

(PLASTIC BOX-11" x 6-3/4" x 1-3/4")

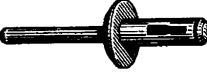

NRA-60 NYLON BLIND RIVET ASSORTMENT

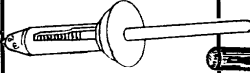

2264  NYLON BLIND RIVET HOLE DIAM: 5 MM (3/16") PANEL RANGE- 3MM- 6MM(1/8"-1/4") HEAD DIAM.- 12 MM (1/2")	2265  NYLON BLIND RIVET HOLE DIAM: 5 MM (3/16") PANEL RANGE- 6 MM-10 MM (1/4"-3/8") HD DIAM-12MM (1/2")	2266  NYLON BLIND RIVET HOLE DIAM: 6.3 MM (1/4") PANEL RANGE- 4 MM- 10 MM (5/32"-3/8") HD DIAM-17MM (11/16")	2267  NYLON BLIND RIVET HOLE DIAM: 6.63 MM (1/4") PANEL RANGE- 2.5 MM- 5 MM 3/32"-3/16") HEAD DIAM.- 18 MM (45/64")	2270  NYLON BLIND RIVET HOLE DIAM: 6.63 MM (1/4") PANEL RANGE- 2.5 MM- 5 MM (3/32"-3/16") HEAD DIAMETER- 13.08MM (1/2")	2355  NYLON BLIND RIVET PANEL RANGE- 6MM-10 5 MM RECTANGULAR HD- 8 MM X 15 MM 3.96 MM DIAM. COWL VENT GRILLE FORD AEROSTAR
2439  NYLON BLIND RIVET HOLE DIAM: 7 MM (9/32") PANEL RANGE- 2.5 MM- 6 MM (3/32"-15/64") HD DIAM.- 18 MM (45/64")	2485  NYLON BLIND RIVET HOLE DIAM: 6.3 MM (1/4") PANEL RANGE 4 MM- 10 MM (5/32"-3/8") HEAD DIAM.- 13 MM (1/2")	2640  NYLON BLIND RIVET HOLE DIAM: 5 MM (3/16") PANEL RANGE- 3 MM- 4 MM (1/8"-5/32") HEAD DIAM.- 9 MM (23/64")	2641  NYLON BLIND RIVET HOLE DIAM: 6 MM (1/4") PANEL RANGE- 4 MM- 8.5 MM (5/32"-21/64") HD DIAM.-13 MM (1/2")	2642  COUNTERSUNK NYLON BLIND RIVET HOLE DIAM: 6.3 MM (1/4") PANEL RANGE- .07 MM-4.5 MM (1/32"-11/64") 2 MM SHOULDER HEAD DIAM.- 17 MM	2653  NYLON BLIND RIVET HOLE DIAM: 6.3 MM (1/4") PANEL RANGE- 8 MM- 12 MM (5/16"-1/2") HEAD DIAM.- 16.8 MM (21/32")

"METRIC CONVERSION TABLE"

Millimeter/Decimal/Fractional Equivalents

METRIC	DEC.	FRACT.	METRIC	DEC.	FRACT.	METRIC	DEC.	FRACT.
0.3968mm	.0156"	1/64"	13mm	.5118"		29mm	1.1417"	
0.7924	.0312	1/32	14	.5512		30	1.1811	
1	.0394		14.2875	.5625	9/16"	35	1.3779	
1.5875	.0625	1/16	15	.5905		38.1	1.5000	1 1/2"
2	.0787		15.8750	.625	5/8	40	1.5748	
3	.1181		16	.6299		45	1.7716	
3.175	.1250	1/8	17	.6693		50	1.9685	
4	.1575		18	.7087		50.8	2.000	2
4.7625	.1875	3/16	19	.748		55	2.1653	
5	.1968		19.05	.750	3/4	60	2.3622	
6	.2362		20	.7874		63.5	2.500	2 1/2
6.35	.2500	1/4	21	.8268		65	2.5590	
7	.2756		22	.8661		70	2.7559	
7.9375	.3125	5/16	22.23	.875	7/8	75	2.9527	
8	.3150		23	.9055		76.2	3.000	3
9	.3543		24	.9449		80	3.1496	
9.525	.375	3/8	25	.9842		85	3.3464	
10	.3937		25.4	1.0000	1	90	3.5433	
11	.4331		26	1.0236		95	3.7041	
11.1125	.4375	7/16	27	1.0630		100	3.9370	
12	.4724		28	1.1024		101.6	4.000	4
12.7	.5000	1/2						



LARGE PLASTIC DRAWER ASSORTMENTS

DRAWER SIZE - 13-1/8" X 9" X 2-5/16"

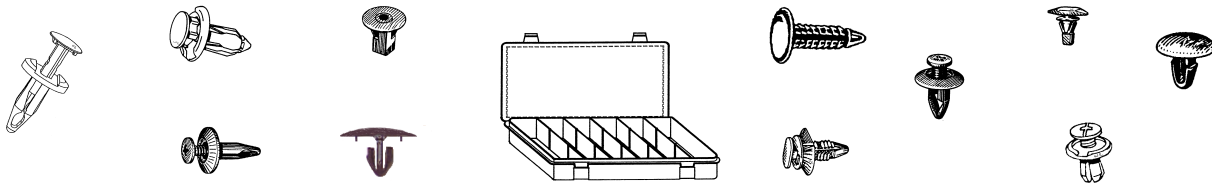

PART

DESCRIPTION

PLA-808 TOYOTA RIVETS AND RETAINERS (190 PCS.)

(CONTAINS W&E #S-2366,2387,2440,2495,2496,2523,2655,2686,2885,2958,2961,2991)

PLA-809 TOYOTA RETAINERS (245 PCS.)

(CONTAINS W&E #S-2375,2417,2492,2493,2851,2893,2913,2962,2972,3017,3095,3100)

PLA-810 NISSAN RETAINERS (225 PCS.)

(CONTAINS W&E #S-2361,2477,2583,2592,2599,2614,2617,2627,2959,2990,3040,3093)

PLA-811 NYLON RIVETS (300 PCS.)

(CONTAINS W&E #S-2264,2265,2266,2267,2270,2355,2439,2485,2640,2641,2642,2653)

PLA-812 PLASTIC RETAINERS-(475 PCS.)

(CONTAINS W&E #S-2223,2388,2420,2437,2438,2682,2923,2977,3008,3013,3058,3107)

PLA-813 PLASTIC RETAINERS-(300 PCS.)

(CONTAINS W&E #S-2453,2458,2699,3023,3078,3210,3212,3215,3224,3244,3245,3260)

PTR-241* IMPORT PUSH TYPE RETAINERS-(174 PCS.)

(CONTAINS W&E #S-2599,2614,2615,2883,2885,2886,2889,2898,2958,2959,2991,3040,
3093,3109,3171,3194,3202,3216,3229,3232,3235,3242,3246,3254)

* PACKED IN W&E PART #PL-24

(ALL ASSORTMENTS PACKED IN W&E PART #PL-12)
USE WITH PLR-5 RACK (NOT INCLUDED)

UNIT PKG.-1 EACH

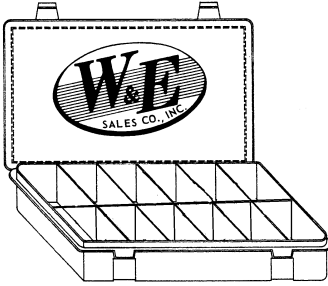

PLASTIC DISPENSER ASSORTMENTS PARTS LISTING

(POLYPROPYLENE BOX - 11" X 6-3/4" X 1-3/4")













**FOR DETAILS ON ALL W&E PLASTIC DISPENSER
ASSORTMENTS SEE PAGES-160 AND 161**

<p style="text-align: center;">PD-121</p> <p style="text-align: center;"><u>PARTS LISTING</u></p> <table style="width: 100%; border: none;"> <tr><td>2361</td><td>2104</td></tr> <tr><td>2366</td><td>2399</td></tr> <tr><td>2405</td><td>2216</td></tr> <tr><td>2902</td><td>2420</td></tr> <tr><td>2388</td><td>2438</td></tr> <tr><td>2398</td><td>2223</td></tr> </table>	2361	2104	2366	2399	2405	2216	2902	2420	2388	2438	2398	2223	<p style="text-align: center;">PD-122</p> <p style="text-align: center;"><u>PARTS LISTING</u></p> <table style="width: 100%; border: none;"> <tr><td>1205</td><td>2140</td></tr> <tr><td>2224</td><td>1225</td></tr> <tr><td>2105</td><td>2512</td></tr> <tr><td>2286</td><td>2204</td></tr> <tr><td>2643</td><td>2347</td></tr> <tr><td>1223</td><td>2107</td></tr> </table>	1205	2140	2224	1225	2105	2512	2286	2204	2643	2347	1223	2107	<p style="text-align: center;">PD-123</p> <p style="text-align: center;"><u>PARTS LISTING</u></p> <table style="width: 100%; border: none;"> <tr><td>5906</td><td>5952</td></tr> <tr><td>5910</td><td>5962</td></tr> <tr><td>5921</td><td>5963</td></tr> <tr><td>5923</td><td>5980</td></tr> <tr><td>5940</td><td>5955</td></tr> <tr><td>5947</td><td>5967</td></tr> </table>	5906	5952	5910	5962	5921	5963	5923	5980	5940	5955	5947	5967
2361	2104																																					
2366	2399																																					
2405	2216																																					
2902	2420																																					
2388	2438																																					
2398	2223																																					
1205	2140																																					
2224	1225																																					
2105	2512																																					
2286	2204																																					
2643	2347																																					
1223	2107																																					
5906	5952																																					
5910	5962																																					
5921	5963																																					
5923	5980																																					
5940	5955																																					
5947	5967																																					
<p style="text-align: center;">PD-124</p> <p style="text-align: center;"><u>PARTS LISTING</u></p> <table style="width: 100%; border: none;"> <tr><td>5902</td><td>5924</td></tr> <tr><td>5903</td><td>5925</td></tr> <tr><td>5908</td><td>5931</td></tr> <tr><td>5917</td><td>5941</td></tr> <tr><td>5920</td><td>5948</td></tr> <tr><td>5922</td><td>5961</td></tr> </table>	5902	5924	5903	5925	5908	5931	5917	5941	5920	5948	5922	5961	<p style="text-align: center;">PD-125</p> <p style="text-align: center;"><u>PARTS LISTING</u></p> <table style="width: 100%; border: none;"> <tr><td>625</td><td>2226</td></tr> <tr><td>671</td><td>2227</td></tr> <tr><td>672</td><td>2484</td></tr> <tr><td>2222</td><td>2193</td></tr> <tr><td>2259</td><td>2322</td></tr> <tr><td>2225</td><td>2423</td></tr> </table>	625	2226	671	2227	672	2484	2222	2193	2259	2322	2225	2423	<p style="text-align: center;">PD-126</p> <p style="text-align: center;"><u>PARTS LISTING</u></p> <table style="width: 100%; border: none;"> <tr><td>2121</td><td>2353</td></tr> <tr><td>2122</td><td>2354</td></tr> <tr><td>2123</td><td>2480</td></tr> <tr><td>2452</td><td>2688</td></tr> </table>	2121	2353	2122	2354	2123	2480	2452	2688				
5902	5924																																					
5903	5925																																					
5908	5931																																					
5917	5941																																					
5920	5948																																					
5922	5961																																					
625	2226																																					
671	2227																																					
672	2484																																					
2222	2193																																					
2259	2322																																					
2225	2423																																					
2121	2353																																					
2122	2354																																					
2123	2480																																					
2452	2688																																					
<p style="text-align: center;">PD-127</p> <p style="text-align: center;"><u>PARTS LISTING</u></p> <table style="width: 100%; border: none;"> <tr><td>2366</td><td>2893</td></tr> <tr><td>2370</td><td>2492</td></tr> <tr><td>2375</td><td>2523</td></tr> <tr><td>2379</td><td>2493</td></tr> <tr><td>2416</td><td>2495</td></tr> <tr><td>2417</td><td>2496</td></tr> </table>	2366	2893	2370	2492	2375	2523	2379	2493	2416	2495	2417	2496	<p style="text-align: center;">PD-128</p> <p style="text-align: center;"><u>PARTS LISTING</u></p> <table style="width: 100%; border: none;"> <tr><td>2211</td><td>2374</td></tr> <tr><td>2248</td><td>2473</td></tr> <tr><td>2381</td><td>2494</td></tr> <tr><td>2236</td><td>2502</td></tr> <tr><td>2503</td><td>2387</td></tr> <tr><td>2277</td><td>2440</td></tr> </table>	2211	2374	2248	2473	2381	2494	2236	2502	2503	2387	2277	2440	<p style="text-align: center;">PD-129</p> <p style="text-align: center;"><u>PARTS LISTING</u></p> <table style="width: 100%; border: none;"> <tr><td>2278</td><td>2236</td></tr> <tr><td>2379</td><td>2339</td></tr> <tr><td>2492</td><td>2503</td></tr> <tr><td>2361</td><td>2277</td></tr> <tr><td>2477</td><td>2374</td></tr> <tr><td>2491</td><td>2502</td></tr> </table>	2278	2236	2379	2339	2492	2503	2361	2277	2477	2374	2491	2502
2366	2893																																					
2370	2492																																					
2375	2523																																					
2379	2493																																					
2416	2495																																					
2417	2496																																					
2211	2374																																					
2248	2473																																					
2381	2494																																					
2236	2502																																					
2503	2387																																					
2277	2440																																					
2278	2236																																					
2379	2339																																					
2492	2503																																					
2361	2277																																					
2477	2374																																					
2491	2502																																					
<p style="text-align: center;">PD-130</p> <p style="text-align: center;"><u>PARTS LISTING</u></p> <table style="width: 100%; border: none;"> <tr><td>2236</td><td>2478</td></tr> <tr><td>2339</td><td>2491</td></tr> <tr><td>2503</td><td>2548</td></tr> <tr><td>2373</td><td>2549</td></tr> <tr><td>2379</td><td>2374</td></tr> <tr><td>2475</td><td>2502</td></tr> </table>	2236	2478	2339	2491	2503	2548	2373	2549	2379	2374	2475	2502	<p style="text-align: center;">PD-131</p> <p style="text-align: center;"><u>PARTS LISTING</u></p> <table style="width: 100%; border: none;"> <tr><td>194</td><td>2057</td></tr> <tr><td>194NA</td><td>2057NA</td></tr> <tr><td>1156</td><td>3057</td></tr> <tr><td>1156NA</td><td>3057NA</td></tr> <tr><td>1157</td><td>3157</td></tr> <tr><td>1157NA</td><td>3157NA</td></tr> </table>	194	2057	194NA	2057NA	1156	3057	1156NA	3057NA	1157	3157	1157NA	3157NA	<p style="text-align: center;">PD-132</p> <p style="text-align: center;"><u>PARTS LISTING</u></p> <table style="width: 100%; border: none;"> <tr><td>2147</td><td>2723</td></tr> <tr><td>2702</td><td>2724</td></tr> <tr><td>2722</td><td>2725</td></tr> </table>	2147	2723	2702	2724	2722	2725						
2236	2478																																					
2339	2491																																					
2503	2548																																					
2373	2549																																					
2379	2374																																					
2475	2502																																					
194	2057																																					
194NA	2057NA																																					
1156	3057																																					
1156NA	3057NA																																					
1157	3157																																					
1157NA	3157NA																																					
2147	2723																																					
2702	2724																																					
2722	2725																																					
<p style="text-align: center;">PD-133</p> <p style="text-align: center;"><u>PARTS LISTING</u></p> <table style="width: 100%; border: none;"> <tr><td>3035</td><td>3108</td></tr> <tr><td>3036</td><td>3276</td></tr> <tr><td>3042</td><td>3279</td></tr> <tr><td>3043</td><td>3280</td></tr> <tr><td>3044</td><td>3282</td></tr> <tr><td>3049</td><td>3286</td></tr> </table>	3035	3108	3036	3276	3042	3279	3043	3280	3044	3282	3049	3286																										
3035	3108																																					
3036	3276																																					
3042	3279																																					
3043	3280																																					
3044	3282																																					
3049	3286																																					













PLASTIC DISPENSER ASSORTMENTS

(PLASTIC BOX-11" X 6-3/4" X 1-3/4")













PD-121 PLASTIC DRIVE RIVET / EXPANSION SCREW

2361  EXPANSION SCREW RIVET INNER FENDER SHIELD NISSAN & UNIVERSAL	2366  EXPANSION SCREW RIVET PANEL RETAINER 6 MM HOLE; 15.2 MM FLANGE TOYOTA	2405  PLASTIC SCREW RIVET-FASCIA/RILLIE FORD, METEER; FORD-'85 & UP	2902  NYLON PUSH RIVET-WHEEL OPENING, COWL VENT FORD, SATURN	2388  DRIVE RIVET-BUMPER FASCIA GENERAL USE GM, FORD	2398  PLASTIC DRIVE RIVET 6.3 MM HOLE SIZE GM, FORD, AMC & CHRYSLER
2104  PLASTIC RIVET-GRILLE TO HEADLAMP BRACKET 11/4" HOLE- FORD & UNIVERSAL	2399  PLASTIC DRIVE RIVET 8 MM HOLE SIZE GM, FORD, CHRYSLER	2216  PLASTIC RIVET-MUD SKIRT ATTACHING, OTHER USES ALSO GM-'73 & '74 CARS-'81 & UP	2420  PUSH TYPE RIVET-8 MM HOLE SIZE GM, FORD	2438  PUSH TYPE BUMPER FASCIA RIVET 9.5 MM HOLE SIZE GM, '87 & UP	2223  PLASTIC RIVET-BLACK FRONT & REAR BUMPER ATTACHING STRIP 1/8" SHOULDER- GM-'81 & UP













PD-122 PLASTIC CHRISTMAS TREE AND SCREW NAIL

1205  DOOR TRIM PANEL FASTENER NYLON; GM PRODUCTS-'71 & UP	2224  DOOR TRIM TO INNER PANEL FASTENER GM-'77 TO '82	2105  RETAINER-INTERIOR DOOR TRIM PANEL NYLON, AMC, GM, FORD, CHRYSLER, VW	2286  RETAINER-CONDUIT TO SHEET METAL IN DOORS NYLON, GM '60" BODY	2643  PLASTIC SHIELD CLIP GM & UNIVERSAL (LONGER THAN W&E #2140)	1223  RETAINER-TRIM & PANEL CLIP UPPER GRILLE-1/4" HOLE SIZE CHRYSLER
2140  SCREW NAIL RETAINER-BLACK 1/4" HOLE GM, CHRYSLER, FORD, AMC	1225  SCREW NAIL RETAINER-BLACK 1/4" HOLE GM, CHRYSLER, FORD, AMC	2512  DOOR PANEL CLIP BUMPER STRIP GM-'80 & UP	2204  PANEL FASTENER-RADIATOR SKIRT ATTACHES CADILLAC & GM	2347  INTERIOR TRIM CLIP-BLACK 7MM HOLE; 20MM HEAD 30MM GRIP RANGE GM, FORD & UNIVERSAL	2107  INTERIOR TRIM RETAINER GM & UNIVERSAL













PD-123 METRIC BODY BOLT ASSORTMENT

5906  8 MM X 25 MM BODY BOLT HEX WASHER HEAD; CA POINT 17 MM WASHER O.D. GM & UNIVERSAL-'77 & UP	5910  8 MM X 30 MM BODY BOLT INDENTED HEX HEAD W/24MM LSE WSHR CA POINT GM & UNIVERSAL	5921  6 MM X 25 MM BODY BOLT INDENTED HEX HEAD W/24MM LSE WSHR CA POINT GM & UNIVERSAL	5923  6 MM X 25 MM BODY BOLT INDENTED HEX HEAD W/17 MM LSE WSHR CA POINT (SMALLER WASHER THAN 5921)	5940  6 MM X 20 MM BODY BOLT INDENTED HEX HEAD WITH LOOSE WASHER DOG POINT	5947  6 MM X 20 MM BODY BOLT INDENTED HEX HEAD WITH 17 MM LOOSE WASHER CA POINT GM & UNIVERSAL
5952  6 MM X 28 MM BODY BOLT INDENTED HEX HEAD (8 MM HEX) WITH 19 MM LOOSE WASHER CA POINT FORD	5962  6 X 35 MM BODY BOLT INDENTED HEX HEAD 17 MM WASHER CA POINT GM & UNIVERSAL	5963  6 X 22 MM BODY BOLT IND. HEX HEAD 19 MM (3/4") WSHR DOG POINT FORD, CHRYSLER & UNIVERSAL	5984  8-1.25 X 30MM HEX WASHER HEAD BODY BOLT-CA POINT (13MM HEX; 17MM WASHER) BLACK	5955  8 MM X 35 MM BODY BOLT INDENTED HEX HEAD WITH 24 MM LOOSE WASHER CA POINT-BLACK GM AND UNIVER-	5967  6 MM X 20 MM HEX WASHER HEAD BODY BOLT-CA PT. 10 MM HEX 13 MM WASHER GM & UNIVERSAL 77 & UP













PD-124 METRIC SPEED, "KEPS" NUT & RETAINER ASSORTMENT

5902  8 MM METRIC FOLDOVER NUT GM, FORD & UNIVERSAL	5903  8 MM LONG THROAT METRIC FOLDOVER NUT GM-'77 & UP, UNIVERSAL	5908  8 MM NUT WITH FREE SPINNING 24 MM WASHER PHOS & OIL GM-'77 & UP	5917  8 MM PUSH NUT BOLT RETAINER 16 MM OUTSIDE DIAMETER	5920  6 MM METRIC SPEED NUT GM-'79 & UP FORD & UNIVERSAL	5922  6 MM NUT WITH FREE SPINNING 16MM TOOTHED WASHER 10 MM HEX, PHOS & OIL VW, GM-'79 & UP
5924  6 MM METRIC SPEED NUT LONG THROAT GM-'X" & "J" CARS & UNIVERSAL	5925  8 MM PUSH NUT BOLT RETAINER 24 MM OUTSIDE DIAMETER	5931  8 MM HEX FLANGE NUT CHRYSLER, GM & UNIVERSAL BLACK	5941  6 MM HEX FLANGE NUT 10 MM HEX SERRATED-BLACK	5948  6 MM NUT WITH FREE SPINNING 19MM WASHER 10 MM HEX, PHOS & OIL GM & CHRYSLER	5961  6 MM NUT WITH FREE SPINNING 17 MM OUTSIDE DIAMETER

PD-125 SPECIAL AUTOBODY SHEET METAL SCREWS ASSORTMENT

625  #8 X 3/8" (#6 HEAD) (3/8" WASHER DIAMETER) PHILLIPS OVAL WASHER HD SELF TAPPING SCREW-PLATED WHEEL OPENING MOULDING SCREW	671  5-20 X 3/8" (7/32" HEAD) PHILLIPS FLAT HD SCREW-PLATED USE WITH PLASTIC MOULDING CLIPS, LANDAU CLIPS (W&E #345) UNIVERSAL	672  #8 X 3/8" SCREW FOR ATTACHING WINDSHIELD & REAR WINDOW REVEAL MOULDING CLIPS (LOW PROFILE HEAD) CHRYSLER & UNIVERSAL-BRIGHT	2222  #4 X 12" (3/8" WSHR DIAM.) PHILLIPS OVAL WASHER HD SELF DRILLING SCREW-PLATED WHEEL OPENING MOULDING SCREW GM & UNIVERSAL	2259  4.2 X 12 MM (#8 X 1/2") (25/64" WASHER DIAMETER) PHILLIPS OVAL WASHER HD SCREW-CHROME BLACK	2225  PHILLIPS FLAT WASHER HD. SCREW-POZIDRIVE 4.2MM X 10MM GM & UNIVERSAL (7/16" WASHER)-BLACK
2226  PHILLIPS FLAT WASHER HEAD SCREW 4.2MM X 20MM-POZIDRIVE (7/16" WASHER) GM & UNIVERSAL-BLACK	2227  PHILLIPS ROUND WASHER HEAD SCREW 4.2MM X 13MM-POZIDRIVE (21/64" WASHER) GM, FORD & UNIVERSAL-BLACK	2484  4.2 X 20 MM PHILLIPS OVAL HEAD SEMS SCREWS FLUSH TYPE WASHER-SELF DRILLING	2193  4.2-1.41X20MM UNSLOTTED-IND. HEX HD SCREW WITH 16MM LOOSE WASHER (7MM HEX) GM & UNIVERSAL	2322  4.2-1.41X 20MM (#8X3/4") UNSLOTTED HEX HD SCREW (12 MM LOOSE WASHER) GM- BLACK	2423  6.3 X 20MM HEX WASHER HEAD SCREW WITH 16MM LOOSE WASHER (10MM HEX) GM PRODUCTS.

PD-126 SPECIAL AUTOMOTIVE RIVETS ASSORTMENT

2121  SUPER SPLIT REGULATOR RIVET 1/4" DIAMETER .30-.140 GRIP .257-.261 HOLE REQUIRED GM, FORD, CHRYSLER-'78&UP	2121  SUPER SPLIT REGULATOR RIVET 1/4" DIAMETER .30-.140 GRIP .257-.261 HOLE REQUIRED GM, FORD, CHRYSLER-'78&UP	2122  SUPER-SPLIT "GLASS STOP" RIVET 1/4" DIAM. .52-.59 GRIP RANGE .257-.261 HOLE REQUIRED FORD, CHRYSLER-'76&UP	2122  SUPER-SPLIT "GLASS STOP" RIVET 1/4" DIAM. .52-.59 GRIP RANGE .257-.261 HOLE REQUIRED FORD, CHRYSLER-'76&UP	2123  SUPER-SPLIT OUTSIDE DOOR HANDLE RIVET-1/4" DIAM. .090-.115" GRIP .90-.125 GRIP REQUIRED FORD, LINCOLN/MERC-'78&UP	2452  DOOR HANDLE RIVET PEEL TYPE 1/4" DIAMETER ZINC & BLACK PHOS. FORD
2321  5/32" ALUMINUM RIVET/ STEEL MANDREL COUNTERSUNK HEAD TRUNK LOCK-SEALED END SWIVEL EMBLEM	2330  1/4" RIVET 1/2" FLANGE FORD STEEL BUMPER RIVET YELLOW ZINC DICHROMATE	2353  1/4" RIVET BUMPER ASSEMBLY .125-.250" GRIP BLACK PHOS. FORD-'81 & UP	2354  3/16" RIVET GRILLE RETAINING 3/8"-1/2" GRIP (LARGE FLANGE-81") BLACK PHOS. FORD-'79 & UP	2480  3/16" RIVET ALL ALUMINUM SCUFF PLATE TO SILL .078-.236 GRIP BLACK FORD-LINCOLN-'89 & UP	2688  1/8" ALL ALUMINUM RIVET-FOR WINDSHIELD SIDE RAIL 3/8" FLANGE DIAMETER .063-.125 GRIP RANGE FORD-'89 & UP BLACK

PLASTIC DISPENSER ASSORTMENTS

(PLASTIC BOX-11" X 6-3/4" X 1-3/4")

PD-127 TOYOTA-TRIM CLIPS, SCREW RIVETS ASSORTMENT					
2366 EXPANSION SCREW RIVET PANEL RETAINER 6MM HOLE; 15.2MM FLANGE TOYOTA	2370 GRILLE CLIP TOYOTA	2375 DOOR PANEL FASTENER TOYOTA, MAZDA, ISUZU GM-NOVA-'85	2379 WEATHERSTRIP & TRIM PANEL CLIP NISSAN, TOYOTA, HONDA	2416 RETAINER-INTERIOR DOOR TRIM '88 TOYOTA CAMRY	2417 RETAINER-INTERIOR DOOR TRIM '88 TOYOTA CAMRY
2893 DOOR TRIM PANEL RETAINER TOYOTA (AVANON & CAMRY) '93 & UP	2492 INTERIOR PANEL FASTENER ISUZU, NISSAN, TOYOTA, MAZDA	2523 PANEL RETAINER TOYOTA	2493 HOOD INSULATION CLIP (30MM HEAD DIAM.; 7MM HOLE) TOYOTA	2495 BLACK NYLON "U" NUT FENDER, WHEELHOUSE TOYOTA	2496 BLACK NYLON "U" NUT FENDER, WHEELHOUSE TOYOTA

PD-128 TOYOTA GROMMETS, RETAINERS ASSORTMENT					
2211 HEADLAMP ADJUSTING SCREW- 5MM	2248 HEADLAMP ADJUSTING NUT TOYOTA & MITSUBISHI	2381 GRILLE NUT/ GROMMET TOYOTA, NISSAN, MITSUBISHI GM-NOVA '85	2236 NUT- SIDE LAMP MARKER- PLASTIC TOYOTA, NISSAN, HONDA, MAZDA, MITSUBISHI AND UNIVERSAL	2503 NYLON SCREW GROMMET MAZDA, HONDA, NISSAN AND TOYOTA	2277 (PLASTIC GROMMET NUT SCREW ANCHOR TOYOTA, NISSAN, MITSUBISHI)
2374 PLASTIC SCREW GROMMET HONDA, TOYOTA, NISSAN, MAZDA	2473 SCREW GROMMET 7.8 MM HOLE, 14 MM HEAD DIAMETER, 16 MM OVERALL LENGTH TOYOTA	2494 PLASTIC GROMMET FENDER SHIELD 6 MM SCREW SIZE 20 MM HEAD 8 X 8 MM HOLE TOYOTA	2502 NYLON SCREW GROMMET-MAZDA NISSAN, HONDA, MIT., TOYOTA	2387 BUMPER CUSHION RETAINER TOYOTA-'92 & UP	2440 BUMPER STRIP RETAINER (STAINLESS STEEL) TOYOTA

PD-129 NISSAN GROMMETS AND RETAINER ASSORTMENT					
2278 TRIM PANEL RETAINER BLACK PLASTIC TOYOTA & DATSUN	2379 WEATHERSTRIP & TRIM PANEL CLIP NISSAN, TOYOTA, HONDA	2492 INTERIOR PANEL FASTENER ISUZU, NISSAN, TOYOTA, MAZDA	2361 EXPANSION SCREW RIVET INNER FENDER SHIELD NISSAN & UNIVERSAL	2477 BUMPER FASCIA RETAINER 22 MM HD DIAM., 11 MM SHOULDER DIAM., 2-10 MM P.R., 8 MM HOLE SIZE NISSAN-'86 & UP	2491 NYLON SCREW RIVET 20 MM HEAD 8 MM HOLE HONDA, NISSAN, MAZDA
2236 NUT- SIDE LAMP MARKER- PLASTIC TOYOTA, NISSAN, HONDA, MAZDA, MITSUBISHI AND UNIVERSAL	2339 PLASTIC NUT GENERAL USAGE NISSAN, HONDA, MAZDA	2503 NYLON SCREW GROMMET MAZDA, HONDA, NISSAN AND TOYOTA	2277 (PLASTIC GROMMET NUT SCREW ANCHOR TOYOTA, NISSAN, MITSUBISHI)	2374 PLASTIC SCREW GROMMET HONDA, TOYOTA, NISSAN, MAZDA	2502 NYLON SCREW GROMMET-MAZDA NISSAN, HONDA, MIT., TOYOTA

PD-130 HONDA-GROMMETS AND RETAINER ASSORTMENT					
2236 NUT- SIDE LAMP MARKER- PLASTIC TOYOTA, NISSAN, HONDA, MAZDA, MITSUBISHI AND UNIVERSAL	2339 PLASTIC NUT GENERAL USAGE NISSAN, HONDA, MAZDA	2503 NYLON SCREW GROMMET MAZDA, HONDA, NISSAN AND TOYOTA	2373 INTERIOR PANEL FASTENER HONDA	2379 WEATHERSTRIP & TRIM PANEL CLIP NISSAN, TOYOTA, HONDA	2475 PLASTIC SCREW RIVET (6MM HOLE) (18MM FLANGE DIAMETER) (2-6MM PANEL RANGE) HONDA
2478 PLASTIC DRIVE RIVET 12 X 18MM HEAD 2MM SHOULDER 8MM HOLE HONDA	2491 NYLON SCREW RIVET 20 MM HEAD 8 MM HOLE HONDA, NISSAN, MAZDA	2549 SCREW RIVET- BUMPER FASCIA 10MM HOLE 20 MM HD DIAM., OCTAGONAL HEAD HONDA-'90 & UP	2548 SCREW RIVET- BUMPER FASCIA 10 MM HOLE 20 MM HD DIAM., 27 MM STEM HONDA-'90 & UP	2374 PLASTIC SCREW GROMMET HONDA, TOYOTA, NISSAN, MAZDA	2502 NYLON SCREW GROMMET-MAZDA NISSAN, HONDA, MIT., TOYOTA

PD-131 MINIATURE BULB ASSORTMENT					
194 SIDE MARKER, INSTRUMENT, LICENSE PLATE	194NA AMBER SIDE MARKER, INSTRUMENT, LICENSE PLATE	1156 SIGNAL, TAIL, STOP PARKING	1156NA AMBER SIGNAL, TAIL, STOP PARKING	1157 SIGNAL, TAIL, STOP PARKING	1157NA AMBER SIGNAL, TAIL, STOP PARKING
2057 SIGNAL, TAIL, STOP PARKING	2057NA AMBER SIGNAL, TAIL, STOP PARKING	3057 SIGNAL, TAIL, STOP BACKUP	3057NA AMBER SIGNAL, TAIL, STOP PARKING	3157 SIDE MARKER, SIGNAL, TAIL, STOP	3157NA AMBER SIDE MARKER, SIGNAL, TAIL, STOP

PD-132 HOLE PLUG ASSORTMENT					
2147 BUTTON PLUG FOR 1/2" HOLES RECESSED HEAD HOLDS ON METAL THICKNESS RANGE FROM .06-.13". ALSO PLUGS HOLES EASILY WHERE METAL THICKNESS IS INCREASED OR IRREGULAR, OR ON CORNER BENDS. USE WHEN RUST-PROOFING.	2702 BUTTON PLUG FOR 3/4" HOLES RECESSED HEAD HOLDS ON METAL THICKNESS RANGE FROM .02-.14". ALSO PLUGS HOLES EASILY WHERE METAL THICKNESS IS INCREASED OR IRREGULAR, OR ON CORNER BENDS. USE WHEN RUST-PROOFING.	2722 FLUSH TYPE HOLE PLUG. USED FOR PAINTLESS DENT REMOVAL AND RUSTPROOFING. HOLE SIZE-1/4" PANEL RANGE-.02-.07	2723 FLUSH TYPE HOLE PLUG. USED FOR PAINTLESS DENT REMOVAL AND RUSTPROOFING. HOLE SIZE-3/8" PANEL RANGE-.02-.05	2724 FLUSH TYPE HOLE PLUG. USED FOR PAINTLESS DENT REMOVAL AND RUSTPROOFING. HOLE SIZE-1/2" PANEL RANGE-.03-.08	2725 FLUSH TYPE HOLE PLUG. USED FOR PAINTLESS DENT REMOVAL AND RUSTPROOFING. HOLE SIZE-3/4" PANEL RANGE-.05-11

PD-133 GM ROCKER PANEL MOULDING CLIP ASSORTMENT					
3035 (11518357) ROCKER PANEL MOULDING CLIP WITH SEALER 9 MM HOLE SIZE TOP HD- 14 X 20 MM OVERALL HT-20 MM	3036 (25722671) ROCKER PANEL MOULDING CLIP WITH SEALER 9 MM HOLE SIZE TOP HD- 12 X 20 MM OVERALL HT-21 MM	3042 (10423553) ROCKER PANEL MOULDING CLIP WITH SEALER 9 MM HOLE SIZE TOP HD- 12 X 20 MM OVERALL HT-21 MM	3043 (25724529) ROCKER PANEL MOULDING CLIP WITH SEALER 9 MM HOLE SIZE TOP HD- 14 X 20 MM OVERALL HT-29 MM	3044 (22603384) ROCKER PANEL MOULDING CLIP WITH SEALER 9 MM HOLE SIZE TOP HD- 19 X 26 MM HEIGHT-22.4MM	3049 (1041395, 10431761) ROCKER PANEL MOULDING CLIP WITH SEALER 9 MM HOLE SIZE TOP HD- 11/16X1-1/2" HEIGHT-1.3764"
3108 (25693852) ROCKER PANEL MOULDING CLIP WITH SEALER 9 MM HOLE SIZE TOP HD- 14 X 20 MM OVERALL HT-20 MM	3276 (10323057) ROCKER PANEL MOULDING CLIP WITH SEALER 9 MM HOLE SIZE TOP HD- 12 X 20 MM LENGTH-20 MM	3279 (10297370) ROCKER PANEL MOULDING CLIP WITH SEALER 9 MM HOLE SIZE TOP HD- 12 X 20 MM LENGTH-25 MM	3280 (11518998) ROCKER PANEL MOULDING CLIP WITH SEALER 9 MM HOLE SIZE TOP HD- 12 X 21 MM LENGTH-25 MM	3282 (15872008) ROCKER PANEL MOULDING CLIP WITH SEALER 15 MM HOLE SIZE TOP HD- 20 X 30 MM LENGTH-28 MM	3286 (11609923) ROCKER PANEL MOULDING CLIP WITH SEALER 9 MM HOLE SIZE TOP HD- 12 X 20 MM OVERALL HT-21 MM

PLASTIC PAK ASSORTMENTS

AF-100 BLADE TYPE FUSE ASSORTMENT		
2540 (5 AMP)	2541 (10 AMP)	2542 (15 AMP)
2543 (20 AMP)	2544 (25 AMP)	2545 (30 AMP)
100 BLADE TYPE FUSES PACKED IN A HANG-UP PLASTIC BOX		

BUS-24 DOOR HINGE BUSHING ASSORTMENT	
2281	2282
2283	2284

CFS-40 COWL- HOOD- FENDER SHIM ASSORTMENT	
965 BODY SHIMS 1/16" THICK	966 BODY SHIMS 1/8" THICK
970 BODY SHIMS 1/16" THICK	972 BODY SHIMS 3/16" THICK

CNA-145 CLIP NUT ASSORTMENT		
846 #8 SCREW SIZE	852 #8 SCREW SIZE	853 #8 SCREW SIZE
2346 #6	858 #10	859 #10

AFA-12 BLADE TYPE FUSE ASSORTMENT-(24 FUSES)		
2540 (5 AMP)	2541 (10 AMP)	2542 (15 AMP)
2543 (20 AMP)	2544 (25 AMP)	2545 (30 AMP)

CPN-250 COTTER PIN ASSORTMENT	
2167	2169 1/8"
2168	2171 5/32" X 1-1/2"

CNA-102 CLIP NUT ASSORTMENT	
853 FENDER CLIP- FRONT END #8A SCREW	2164 "U" TYPE CLIP- #10A SCREW
860 FRONT END CLIP- #14A SCREW	814 "U" TYPE CLIP- #14 SCREW

DRC-300 DOOR LOCK ROD END CLIP ASSORTMENT		
2505 DOOR LOCK CLIP R.H.	2506 DOOR LOCK CLIP- L.H.	2507 DOOR LOCK CLP- R.H.
2508 DOOR LOCK CLIP L.H.	2509 DOOR LOCK CLIP R.H.	2625 DOOR LOCK CLIP-R.H.



PLASTIC PAK ASSORTMENTS

HPB-9 DOOR HINGE PIN AND BUSHING ASSORTMENT			
2357	2358		
2359	2360	2327	
2281	2282	2283	2284

HPB-17 DOOR HINGE PIN AND BUSHING ASSORTMENT				
2357	2360			
2358	2635			
2359	2638			
2281	2282	2283	2284	2638
2327	2457	2646	2600	2646
				2639

GMT-25 GM TRUCKS DOOR HINGE AND BUSHING ASSORTMENT		
2714	2753	
2896	2740	2648
2741	3070	

PLASTIC PAK ASSORTMENTS

W&E SALES CO., INC.

ECA-130 "E" CLIP ASSORTMENT

2646 1/4" SHAFT DIAM.		2645 3/16" SHAFT DIAM.	
2648 3/8" SHAFT DIAM		2647 5/16" SHAFT DIAM.	

W&E SALES CO., INC.

VTC-50 VACUUM TEE AND CAP ASSORTMENT

2426 (357020) (6272766) (22508050) (373046-S) (3671410) (3673945) 3/16" X 3/16" X 3/16" THREE WAY VACUUM TEE GM, FORD, CHRYSLER & UNIVERSAL	2427 (560625) (22508051) (383003) (389138) (4104998) 3/16" X 3/16" CONNECTOR GM, FORD, CHRYSLER & UNIVERSAL	2430 (14017705) (3895904) (3751212) 1/8" X 1/8" X 1/8" THREE WAY VACUUM TEE GM, FORD, CHRYSLER & UNIVERSAL	2431 1/4" X 1/4" X 1/4" THREE WAY VACUUM TEE GM & UNIVERSAL	2428 3/16" VACUUM CAP GM, FORD, CHRYSLER AND UNIVERSAL	2988 1/8" VACUUM CAP GM, FORD, CHRYSLER AND UNIVERSAL	2989 1/4" VACUUM CAP GM, FORD, CHRYSLER AND UNIVERSAL
---	--	--	---	---	--	--

W & E

HLN 75 HEADLAMP AND OTHER USE-PLASTIC & NYLON NUTS

815 HEADLAMP DOOR RETAINING NUT (NYLON)		819 GRILLE NUT — NYLON 1/4" HOLE #8-10SCR	
825 HEADLAMP & LICENSE PLATE PLASTIC NUT		832 PLASTIC HEADLAMP DOOR UPPER RETAINER	

W&E SALES CO., INC.

LPN-46 LICENSE PLATE NUT & SCREW ASSORTMENT

963 1/4-20 X 1/2" SLOTTED TRUSS HEAD WITH HEX NUT	818 LICENSE PLATE NUT USE #14 SCREW	2203 1/4 X 3/4" HEX WSHR HEAD - SLOTTED SCREW
826 LICENSE PLATE NUT USE #14 SCREW	537 1/4 X 3/4" SLOTTED PAN HEAD SCREW	2295 LICENSE PLATE NUT USE #14 SCREW

W&E SALES CO., INC.

MET-501 METRIC THREAD CUTTING NUTS ASSORTMENT

5990 3.2 MM		5913 4 MM	
5914 5 MM		2562 6.3 MM	

"METRIC CONVERSION TABLE"

Millimeter/Decimal/Fractional Equivalents

METRIC	DEC.	FRACT.	METRIC	DEC.	FRACT.	METRIC	DEC.	FRACT.
0.3968mm	.0156"	1/64"	13mm	.5118"		29mm	1.1417"	
0.7924	.0312	1/32	14	.5512		30	1.1811	
1	.0394		14.2875	.5625	9/16"	35	1.3779	
1.5875	.0625	1/16	15	.5905		38.1	1.5000	1 1/2"
2	.0787		15.8750	.625	5/8	40	1.5748	
3	.1181		16	.6299		45	1.7716	
3.175	.1250	1/8	17	.6693		50	1.9685	
4	.1575		18	.7087		50.8	2.000	2
4.7625	.1875	3/16	19	.748		55	2.1653	
5	.1968		19.05	.750	3/4	60	2.3622	
6	.2362		20	.7874		63.5	2.500	2 1/2
6.35	.2500	1/4	21	.8268		65	2.5590	
7	.2756		22	.8661		70	2.7559	
7.9375	.3125	5/16	22.23	.875	7/8	75	2.9527	
8	.3150		23	.9055		76.2	3.000	3
9	.3543		24	.9449		80	3.1496	
9.525	.375	3/8	25	.9842		85	3.3464	
10	.3937		25.4	1.0000	1	90	3.5433	
11	.4331		26	1.0236		95	3.7041	
11.1125	.4375	7/16	27	1.0630		100	3.9370	
12	.4724		28	1.1024		101.6	4.000	4
12.7	.5000	1/2						

W&E SALES CO., INC.

MET-502 METRIC PUSH NUT BOLT RETAINER ASSORTMENT







5916 (6.3 MM)		5917 (8 MM)	
5918 (10 MM)		5919 (12 MM)	

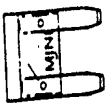

PLASTIC PAK ASSORTMENTS



MFA-50
MINI FUSE ASSORTMENT

2689 (2 AMP) 	2691 (4 AMP) 2692 (5 AMP) 	2693 (7.5 AMP) 2694 (10 AMP) 
2695 (15 AMP) 2696 (20 AMP) 	2697 (25 AMP) 	2698 (30 AMP) 





NT-15M
METRIC INSERT ASSORTMENT



NT-15M-4	NT-15M-8	NT-15M-10
NT-15M-6	5944-4MM 5942 6MM 	5943-8MM 
5944-10MM 		

POCA-402
PUSH ON CLIPS ASSORTMENT



885 1/16" STUD 	886 3/32" STUD 
887 1/8" STUD 	888 5/32" STUD 



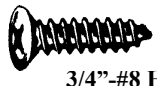
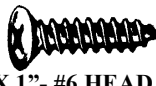
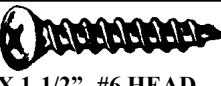
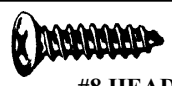

POS-150
PHILLIPS OVAL HEAD SCREW ASSORTMENT



655 #10 X  3/4"-#8 HEAD	658 #10 X 1"- #6 HEAD 
660 #10 X 1-1/2"- #6 HEAD 	659 #10 X 1"- #8 HEAD 





POS-160
PHILLIPS OVAL HEAD SCREW ASSORTMENT



636 #8 X 1" (# 6 HEAD) 	639 #8 X 1-1/4" (# 6 HEAD) 
2501 #8 X 1-1/2" (# 6 HEAD) 	641 #8 X 1-3/4" (# 6 HEAD) 





POS-260
PHILLIPS OVAL HEAD SCREW ASSORTMENT



633 #8 X 5/8"-#6 HEAD 	2498 #8 X 3/4"- #6 HEAD 
635 #8 X 3/4" 	637 #8 X 1" 







PPS-255
PHILLIPS PAN HEAD SCREW ASST.



680 #6 X 1/2"- ZINC 	682 #8 X 1/2"- ZINC 
684 #10 X 1/2"- ZINC 	686 #10 X 3/4"-ZINC 



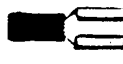

QEC-120
QUICK ELECTRICAL CONNECTOR ASSORTMENT







424 RING TONGUE #16-14 WIRE; #8-10 STUD 	433 SPADE TONGUE #16-14 WIRE; #8-10 	441 BUTT CONNECTOR NYLON #16-14 WIRE 
446 MALE QUICK DISCONNECT #16-14 WIRE 	445 FEMALE QUICK DISCONNECT 	449 SNAP PLUG #16-14 WIRE 

PLASTIC PAK ASSORTMENTS







 **SEMS-70**
CHROME FINISHING SEMS
ASSORTMENT

1653 #8 X  1" (#6)	1659 #10 X  1" (#6)
1651 #8 X 5/8" (#6 HEAD) 	1652 #8 X 3/4" (#6 HEAD) 

 **STGA-195**
SELF THREADING NUT
ASSORTMENT

920 1/8" STUD 	921 3/16" STUD 
922 1/4" STUD 	923 5/32" STUD 







 **TXS-110**
TORX DRIVE SHEET METAL SCREW
ASSORTMENT

2184  4.2MM X 20MM OVAL HD CHROME	2186  4.2 MM X 20MM PAN HD. CHROME	2188  4.2MM X 30MM OVAL HD.CHROME
2185  4.2 MM X 20MM OVAL HD.-BLACK	2187  4.2MM X 20MM PAN HEAD- BLACK	2189  4.2MM X 30 MM OVAL







 **TCA-290**
TUBULAR CLIP ASSORTMENT

874 3/32" STUD 	875 1/8" STUD 	878 3/16" STUD 
878 3/16" STUD 	879 3/16" STUD 	879 3/16" STUD 



 **SRA-100**
UNTHREADED STUD RETAINER
ASSORTMENT

2464  3/32" STUD	2465  1/8" STUD	2466  5/32" STUD
2467  3/16" STUD (7/16" O.D.)	2468  1/4" STUD	2469  3/8" STUD

 **TKS-105**
SELF-DRILLING SCREW
ASSORTMENT

2222  #8X1/2"-ZINC	2340  #8X1/2"-BLACK	2463  4.2 MM X20 MM FLUSH WSHR
2482  #8X7/8"- ZINC	2484  4.2 MM X 20 MM FLUSH WSHR	2685  #8X1/2"-BLACK



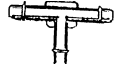











 **VTA-26**
VACUUM TEE ASSORTMENT















2427  3/16" X 3/16" CONNECTOR	2430  1/8" X 1/8" X 1/8" 3 WAY TEE
2426  3/16" X 3/16" X 3/16" 3 WAY TEE	2431  1/4" X 1/4" X 1/4" 3 WAY TEE

PLEASE VISIT OUR WEBSITE AT:

WWW.WESALES.COM

PLASTIC PAK ASSORTMENTS

 FL-1400 FLAT WASHER, LOCK WASHER ASSORTMENT (DRAWER SIZE - 13-1/8" X 9" X 2-5/16") 					
4200  3/16" FLAT WASHER	4201  1/4" FLAT WASHER	4202  5/16" FLAT WASHER	4203  3/8" FLAT WASHER	4204  7/16" FLAT WASHER	4205  1/2" FLAT WASHER
4210  3/16" LOCK WASHER	4211  1/4" LOCK WASHER	4212  5/16" LOCK WASHER	4213  3/8" LOCK WASHER	4214  7/16" LOCK WASHER	4215  1/2" LOCK WASHER









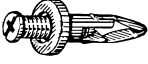

 MW-1000 METRIC FLAT WASHER, LOCK WASHER ASSORTMENT (PLASTIC BOX SIZE-11" X 6-3/4" X 1-3/4") 					
5970  4 MM FLAT WASHER	5971  5 MM FLAT WASHER	5949  6 MM FLAT WASHER	5950  8 MM FLAT WASHER	5951  10 MM FLAT WASHER	5951  10 MM FLAT WASHER
5972  4 MM LOCK WASHER	5973  5 MM LOCK WASHER	5956  6 MM LOCK WASHER	5957  8 MM LOCK WASHER	5958  10 MM LOCK WASHER	5958  10 MM LOCK WASHER

PLASTIC PAK ASSORTMENTS

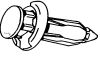

ACC-131 HONDA ACCORD RETAINER ASSORTMENT (PLASTIC BOX SIZE-11" X 6-3/4" X 1-3/4")

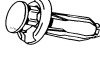

























<p>2548</p>  <p>(91502-SM4-000) SCREW RIVET- BUMPER FASCIA HONDA -'90 & UP HOLE SIZE-10 MM HD. DIAM.-20 MM; STEM-27 MM</p>	<p>2549</p>  <p>(91504-SM4-000) SCREW RIVET- BUMPER FASCIA OCTAGONAL HEAD HONDA -'90 & UP HOLE SIZE-10 MM</p>	<p>2609</p>  <p>(91503-SP0-0030) SCREW RIVET BUMPER STRIP RETAINER ACURA-'91 & UP HOLE SIZE-10MM; HD.DIAM.-20 MM STEM LENGTH-15 MM</p>	<p>2613</p>  <p>(90505-SM4-003) SCREW RIVET, SILL PLATE MOULDING; HONDA ACCORD HOLE SIZE-8 MM HD.DIAM.-18 MM</p>	<p>2758</p>  <p>(91512-SM4-003) SCREW RIVET FENDER SPLASH SHIELD HONDA ACCORD '90 & UP HOLE SIZE-8 MM; HD.DIAM.-20 MM STEM LENGTH-9 MM</p>	<p>2844</p>  <p>(N807438S, W704643) (REPLACES-91568-SR2-003, 91530-SP1-003) WEATHERSTRIP RETAINER FORD & HONDA HOLE SIZE-5 MM HEAD SIZE-5 X 15 MM STEM-10 MM</p>
<p>2883</p>  <p>(91503-SZ3-003) PLASTIC PUSH RIVET FRONT GRILLE AND BUMPER HONDA -'96 & UP HOLE SIZE-10 MM; FLANGE O.D.-20 MM STEM-13 MM</p>	<p>2884</p>  <p>(91502-SPO-003) PLASTIC SCREW RIVET FRONT AND REAR BUMPER HONDA-'90 & UP HOLE SIZE-10 MM; HD. DIAM.-20 MM</p>	<p>2889</p>  <p>(91512-SXO-003) PLASTIC PUSH RIVET FRONT FENDER HONDA/ HOLE SIZE-8MM; HD.DIAM.-20MM OVERALL LENGTH-13.4 MM</p>	<p>2898</p>  <p>(91503-SZ5-003) PLASTIC PUSH RIVET FRONT GRILLE AND BUMPER HONDA- '98 & UP HOLE SIZE-10 MM FLANGE OD-20 MM; STEM- 17 MM</p>	<p>2966</p>  <p>(91518-SM4-003) RETAINER-HOOD & TRUNK MOULDING HONDA- ACURA & CIVIC-'94 & UP HOLE SIZE-6 MM HEAD DIAM.-12 MM STEM-9 MM</p>	<p>2973</p>  <p>(90700-SJ4-000) HOOD INSULATION CLIP- HONDA- ACCORD-'91 & UP HEAD DIAM.-30 MM OVERALL LENGTH -12 MM</p>



TEK-530 "SELF DRILLING" TYPE SCREW ASSORTMENT (DRAWER SIZE - 13-1/8" X 9" X 2-5/16")



<p>2409</p>  <p>UNSLOTTED HEX WASHER HEAD #8 X 1/2"</p>	<p>2150</p>  <p>UNSLOTTED HEX WASHER HEAD #8 X 3/4"</p>	<p>2659</p>  <p>UNSLOTTED HEX WASHER HEAD #8 X 1"</p>	<p>2620</p>  <p>UNSLOTTED HEX WASHER HEAD #10 X 1/2"</p>	<p>2660</p>  <p>UNSLOTTED HEX WASHER HEAD #10 X 3/4"</p>	<p>2275</p>  <p>UNSLOTTED HEX WASHER HEAD #10 X 1"</p>
<p>2764</p>  <p>UNSLOTTED HEX WASHER HEAD #12 X 3/4"</p>	<p>2765</p>  <p>UNSLOTTED HEX WASHER HEAD #14X3/4"</p>	<p>2486</p>  <p>UNSLOTTED HEX WASHER HEAD #14 X 1"</p>	<p>3068</p>  <p>UNSLOTTED HEX WASHER HEAD#14 X 1-1/4"</p>	<p>3069</p>  <p>UNSLOTTED HEX WASHER HEAD #14 X 1-1/2"</p>	<p>2685</p>  <p>PHILLIPS FLAT TOP WASHER HEAD #8 X 1/2"-BLACK</p>
<p>2222</p>  <p>PHILLIPS OVAL WASHER HEAD #8 X 1/2"-BRIGHT</p>	<p>2340</p>  <p>PHILLIPS FLAT WASHER HEAD #8 X 1/2"-BLACK</p>	<p>2796</p>  <p>PHILLIPS FLAT TOP WASHER HEAD-BLACK 4.2 X 16 MM</p>	<p>2797</p>  <p>PHILLIPS FLAT TOP WASHER HEAD-BLACK 4.2 X 19 MM</p>	<p>2798</p>  <p>PHILLIPS FLAT TOP WASHER HEAD-BLACK 4.2 X 25 MM</p>	<p>2482</p>  <p>PHILLIPS ROUND WASHER HEAD #8 X 7/8"-ZINC</p>
<p>2657</p>  <p>PHILLIPS PAN HEAD #8 X 1/2"-ZINC</p>	<p>2658</p>  <p>PHILLIPS PAN HEAD #8 X 1"-ZINC</p>	<p>2996</p>  <p>PHILLIPS OV HD FINISHING SEMS COUNTERSUNK WSHR #8 X 3/4"-CHROME</p>	<p>2997</p>  <p>PHILLIPS OV HD FINISHING SEMS COUNTERSUNK WSHR #8 X 3/4"-BLACK</p>	<p>3015</p>  <p>INDENTED HEX WSHR HD- 12 MM L/S WSHR 4.2 X 20 MM-BLACK</p>	<p>3016</p>  <p>INDENTED HEX WSHR HD- 16 MM L/S WSHR 4.2 X 20 MM-BLACK</p>



CTA-400 BLACK CABLE TIE ASSORTMENT

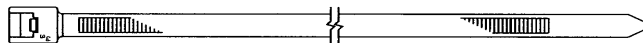

IN REUSABLE HANG-UP PLASTIC BOX-CONTAINS 400 CABLE TIES:
 (200-4" 18# TENSILE STRENGTH-#2865)
 (100-7" 50# TENSILE STRENGTH-#2385)
 (100-11" 50# TENSILE STRENGTH-#2386)
 UNIT PKG.-1



THREADED INSERT KITS

NT-11 USS THREADED INSERT KIT

KIT CONTAINS:

- 2154-10-24 INSERT (9/32" REQUIRED HOLE SIZE)**
2155-1/4-20 INSERT (3/8" REQUIRED HOLE SIZE)
2156-5/16-18 INSERT (1/2" REQUIRED HOLE SIZE)
NT-11-1024-TOOL
NT-11-1/4-20-TOOL
NT-11-5/16-18-TOOL
UNIT PKG.-1



NT-15M METRIC THREADED INSERT KIT

KIT CONTAINS:

- 5974-4 MM INSERT**
5942-6 MM INSERT
5943-8 MM INSERT
5944-10 MM INSERT
NT-15M-4-TOOL
NT-15M-6-TOOL
NT-15M-8-TOOL
NT-15M-10-TOOL
UNIT PKG.-1



THREADED INSERT TOOLS

- NT-11-1024 (USE FOR #2154)**
NT-11-1/4-20 (USE FOR #2155 & 2903)
NT-11-5/16-18 (USE FOR #2156)
NT-15M-4 (USE FOR #5974 & 3300)
NT-15M-5 (USE FOR #3085 & 3149)
NT-15M-6 (USE FOR #5942 & 2904)
NT-15M-8 (USE FOR #5943)
NT-15M-10 (USE FOR #5944)

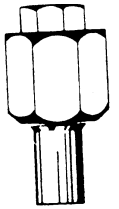

EACH UNIT PKG.-1

THREADED INSERTS-STEEL, PLATED



<u>PART #</u>	<u>THREAD SIZE</u>	<u>HOLE SIZE</u>	<u>PANEL RANGE</u>	<u>UPKG.</u>
2154	10-24	9/32"	.03-.165"	25
2155	1/4-20	3/8"	.03-.165"	25
2156	5/16-18	1/2"	.03-.165"	10
5974	4 MM	6.75 MM	0.5-2.0 MM	25
3149	5 MM	7.6 MM	0.5-3.3 MM	25
5942	6 MM	10.0 MM	0.7-4.2 MM	15
5943	8 MM	13.5 MM	0.7-3.8 MM	10
5944	10 MM	13.5 MM	0.7-3.8 MM	10

THREADED INSERTS- HEXAGONAL HOLE STEEL, PLATED



<u>PART #</u>	<u>THREAD SIZE</u>	<u>PANEL RANGE</u>
2903	1/4-20	.03-.165" (3/8" ACROSS THE FLAT)
3300	4 MM	2-3.3 MM (9 MM HEAD DIAMETER 6.35 MM ACROSS THE FLATS)
3085	5 MM	0.5-3.3 MM (7 MM HEX, 10 MM HEAD DIAM.)
2904	6 MM	0.7-4.2 MM (9.5 MM ACROSS THE FLAT)

EACH UNIT PKG.-15

EFA LARGE METAL DRAWER ASSORTMENTS: (DRAWER SIZE: 18" X 12" X 3")



CONTAINS ONE FULL BOX OF EACH FASTENER ITEM IN THAT PARTICULAR CATEGORY

<u>PART #</u>	<u>DESCRIPTION</u>
EFA-1	PLASTIC "CHRISTMAS TREE" FASTENERS, WEATHERSTRIP & HOOD CLIPS, GROMMETS (840 PCS.)
EFA-2	PLASTIC PUSH TYPE AND SCREW RIVET RETAINERS-DOMESTIC AND IMPORTS (470 PCS.)
EFA-3	SPECIAL SHEET METAL SCREWS, CLIP NUTS, SPECIALTY RIVETS, BOLTS AND SHIMS (1,730 PCS.)
EFA-4	METRIC BODY BOLTS, FREE SPINNING AND FLANGE NUTS AND "U" TYPE NUTS (715 PCS.)

EACH UNIT PKG.-1



EFA-5 ESSENTIAL AUTO BODY FASTENER ASSORTMENT SET UP



A FULLY LABELED, LARGE DRAWER ASSORTMENT
OF 94 ESSENTIAL BODY SHOP FASTENERS.

IDEAL FOR THE SHOP THAT WANTS TO ORGANIZE THEIR MOST OFTEN NEEDED
FASTENERS. COMBINED WITH THE INCLUDED W&E SALES "WE TRAK" SOFTWARE,
FASTENERS USED ON A SPECIFIC JOB CAN BE INVOICED SEPARATELY. THE COMPLETE
SETUP INCLUDES: FOUR FULLY LABELED DRAWERS A HEAVY DUTY STEEL RACK, ONE
BOX OF EACH PART IN THE ASSORTMENT, (A TOTAL OF 3,755 PIECES)
AND ONE COPY OF THE "WE TRAK" INVOICING SOFTWARE.

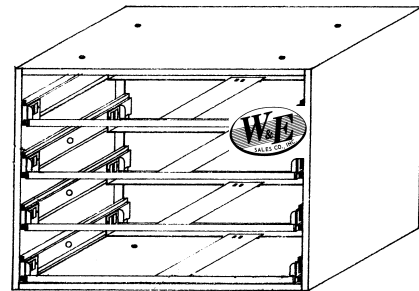

EFA ASSORTMENT PARTS LISTING

EFA-1:

818
1223
1225
2140
2204
2274
2347
2356
2364
2379
2414
2418
2493
2494
2523
2618
2628
2643
2644
2687
2844
2230

EFA-2:

2216
2264
2265
2266
2267
2361
2366
2388
2398
2415
2420
2460
2491
2548
2550
2551
2609
2613
2758
2883
2885
2886
2889
2898

EFA-3:

811
915
942
965
966
1220
2121
2122
2123
2162
2193
2203
2222
2226
2255
2322
2340
2345
2353
2354
2452
2480
2630
2688

EFA-4:

2423
5901
5902
5903
5904
5906
5908
5910
5911
5920
5921
5922
5923
5924
5931
5938
5940
5941
5947
5948
5952
5962
5963
5965



STORAGE CABINETS/ RACKS

18D

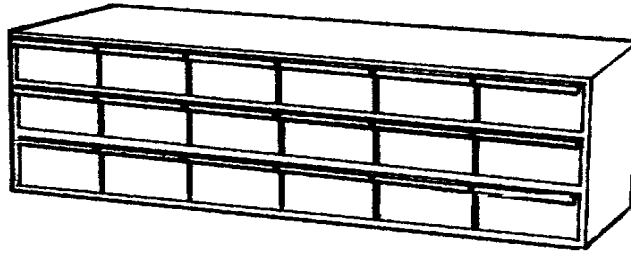

18 DRAWER STORAGE CABINET MADE OF HEAVY STEEL CONSTRUCTION. VERY USEFUL TO THE SHOP THAT NEEDS THEIR FASTENER AREA ORGANIZED. EACH SLIDE OUT DRAWER CAN BE SECTIONED OFF INTO THREE COMPARTMENTS TO MAXIMIZE THE NUMBER OF ITEMS BEING STORED. A PERFECT WAY TO SET UP A NEW CUSTOMER OR ORGANIZE AN OLD ONE.

WIDTH-34" HEIGHT-11" DEPTH-11-5/8"

UNIT PKG.-1

36B

**36 COMPARTMENT
STORAGE BIN
"SLIDE OUT
DIVIDERS"
WIDTH-23-5/8" HEIGHT-23-
5/8" DEPTH-4-3/4"
CAN BE WALL MOUNTED
UNIT PKG.-1**

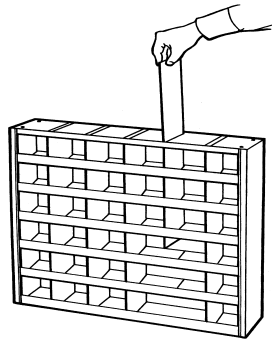

PB-18

**18 COMPARTMENT STORAGE BIN
"SLIDE OUT
DIVIDERS"
WIDTH-23-3/4" HEIGHT-12-1/4" DEPTH-4-3/4"
CAN BE WALL MOUNTED
UNIT PKG.-1**

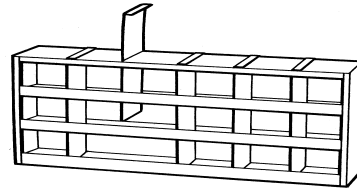

**CR-4
AND
CR-6**

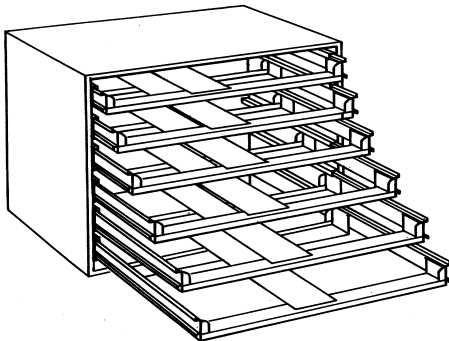

**CABINET RACKS CONTAINING 4 OR 6
"SLIDE OUT" DRAWER BRACKETS.
OUTSIDE DIMENSIONS:**

CR-4: 15-1/4" WIDE, 11-3/4" DEEP, 10-3/4" HIGH

CR-6: 15-1/4" WIDE, 11-3/4" DEEP, 15-1/2" HIGH
EACH RACK HOLDS W&E PARTS B-12 OR B-24
DRAWERS

**(DRAWERS NOT INCLUDED)
EACH UNIT PKG.-1**

4LR

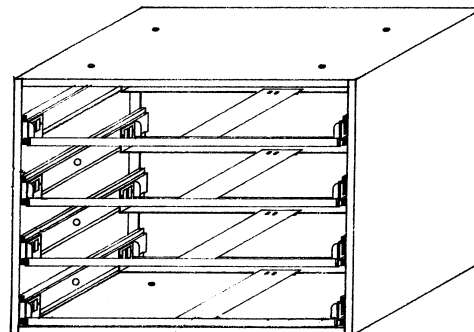

**LARGE CABINET RACK
CONTAINING 4
"SLIDE OUT" DRAWER BRACKETS.
OUTSIDE DIMENSIONS:
20" WIDE, 15-3/4" DEEP, 14-1/2" HIGH
HOLDS 4-W&E# DL-24 DRAWERS
(DRAWERS NOT INCLUDED)**

UNIT PKG.-1

STORAGE CABINETS/ RACKS/ DRAWERS

DL-24

**LARGE 24 COMPARTMENT
METAL STORAGE DRAWER WITH PLASTIC
INSERT-"SCOOP OUT" COMPARTMENTS**

**WIDTH-18" DEPTH-12" HEIGHT-3"
(USE WITH 4LR STORAGE RACK)**

UNIT PKG.-1

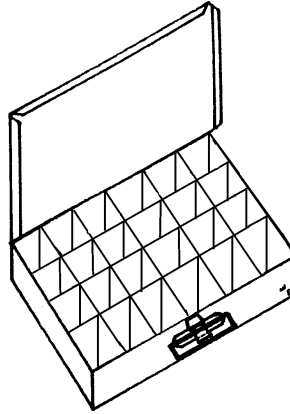

PLR-5

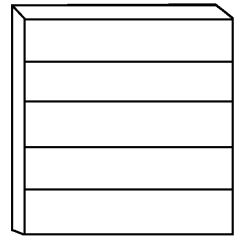

**METAL STORAGE RACK FOR
PARTS PL-12 & PL-24
SIZE:13-1/2"X13-1/4"X9-1/8"
HOLDS FIVE STORAGE BOXES
UNIT PKG.-1**

B-12:

12 COMPARTMENT METAL STORAGE DRAWER

B-16:

16 COMPARTMENT METAL STORAGE DRAWER

B-24:

24 COMPARTMENT METAL STORAGE DRAWER

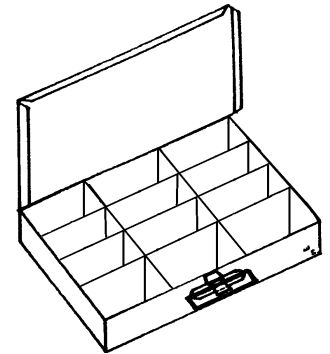

**USE WITH W & E PART # CR-4 OR CR-6
PLASTIC INSERT CONTAINS "SCOOP OUT"
COMPARTMENTS-IDEAL FOR STORAGE OF SMALL PARTS.
DIMENSIONS: 13-3/4" WIDE, 9-1/4" DEEP, 2" HIGH**

EACH UNIT PKG.-1

POLYPROPYLENE STORAGE BOXES

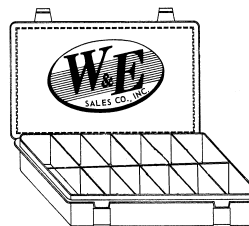
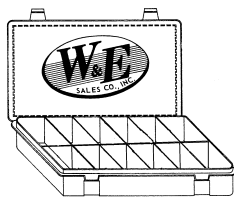

<u>PART #</u>	<u>SIZE</u>	<u>COMPARTMENTS</u>
M-602	11"X6-3/4"X1-3/4"	12
PL-12	13-1/8"X9"X2-5/16"	12
PL-24	13-1/8"X9"X2-5/16"	24

(PL-12 & PL-24 CAN BE USED WITH THE PLR-5 RACK AT TOP OF PAGE)

EACH UNIT PKG.-1

WE TRAK® AND WETRAK3® **FASTENER INVOICING SOFTWARE**



“WE TRAK” is a complete software program designed for body and glass shops to create supplemental invoices for fasteners and shop supplies. The ability to produce receipts that are acceptable to the insurance companies should make the small amount of data entry well worth the time required.

“WE TRAK” features the following:

- Complete listing of W&E part numbers; with descriptions and per piece cost pricing.
- A markup recalculation feature allowing the shop to set their own profit margin.
- A customer database section to store and maintain customer records.
- Other supplies used in the shop can be added to the system as needed.

Each “WE TRAK” software program is shipped with the W&E distributor’s name, address and phone number hard coded into the program. Once installed on the shop’s computer, call to register the program with W&E. All we need is the shop name and a password will be issued.

Updates for new items and any price changes will be available by email-
Part number **WTUE** or by CD- Part number- **WTUCD**.

The “WETRAK3” program offers the following new features:

- 1.-The ability to receive scanned information into the program. Eliminates the need to manually key information into the system. Use your own barcode scanner.
- 2.-Inventory control- helps keep track of your hardware usage while allowing you to maintain an adequate supply of body fasteners. Jobbers may scan the label on the W&E parts box and the inventory will automatically update.
- 3.-The ability to produce your own bin labels containing the part number, description and a bar code for any part entered into the system.
- 4.-Use your existing computer or net book to run the software.

There are two ordering options:

- 1.- **WETRAK**- Basic part invoicing program.
- 2.- **WETRAK3®**- software program for shops who prefer to use their own scanner & track inventory.

(Simply install the software on your existing computer, call W&E Sales to register your program.)
Unit Pkg.-1

OEM/W&E CROSS REFERENCE GUIDE

OEM #	W&E #	PG. #	OEM #	W&E #	PG. #	OEM #	W&E #	PG. #
000-988-1581	2197	14	10126901	2705	46	11500971	5984-disc-sec#5980	91
000-988-6081	2315	15	10131511	3190	73	11500996	2634	78
000-988-7881	2317	16	10134407	2398	50	11501003	2800	78
002-997-338667	2759	32	10137292	2810	112	11501099	5965	95
003-988-1978	2195	18	10140480	2682	62	11501188	5910	92
003-988-2078	2196	18	10142872	2908	68	11501189	5955	92
003-990-94-97	see#3422	72	10143422	2455	39	11501193	5911	92
008934202672	2398	50	10146315	2863	42	11501794	2259	87
01281-00023	2277	104	10153057	2490	46	11501836	use#2562	98
01281-00111	3092	107	10157900	2739	53	11501849	5926-disc.sec#5918	96
01281-00691	3338	108	1016937	5920	90	11501850	5909	95
01281-00831	3211	108	10169777	3011	33	11501867	2763	84
01281-01081	3168	107	10182300	3097	44	11501883	2860	87
01281-01321	3169	107	10184895	2485	76	11501884	2226	80
01515-0009U	3190	73	10185866	2952	42	11501889	5931	95
01553-00051	2278	39	10185925	2347	41	11501896	2227	81
01553-00172	2379	32	10195515	2718	62	11501903	2225	80
01553-00291	2964	35	10201332	3193	73	11501929	3115	83
01553-0034U	3434		10246149	3024	63	11501932	5914	98
01553-00755	2614	52	10257286	2978	48	11502470	2463	85
01553-0075U	3170	44	10262143	2984	106	11502504	5917	96
01553-01393	2624	61	10273233	see#3417	27	11502507	5946	98
01553-0167U	3215	57	10274778	3045	69	11502540	5913	98
01553-02821	3059	49	10283414	2845	32	11502702	5938	95
01553-03101	2477	61	10285935	2795	47	11502785	5901	90
01553-03831	2369	18	10287926	3039	17	11502834	2487-discontinued	
01553-05323	3346	60	10287971	2794	47	11502836	2488	86
01553-06721	2599	52	10293193	3205	35	11502853	5917	96
01553-09241	3040	55	10293674	2848	33	11502970	5927	92
01553-09321	2959	54	10297370	3279	30	11503396	2322	77
01553-09331	2990	33	10301966	3038	55	11503397	2489	77
01553-09611	3093	56	10323057	3276	23	11503403	2193	77
01553-56500	2706	39	10352799	3116	23	11503421	2665	81
01651-00481	2374	104	10352803	3129	23	11503436	2287	77
04388293	2399	50	10363811	use #3218	40	11503483	2322	77
0501094C1	2707	46	10405030	2845	32	11503552	2488	86
05257478	2625	66	10411395	3049	22	11503555	2762	82
0G032-50037A	3272	63	10421018	3010	40	11503569	2325	81
10005510	2220	89	10423331	3022	106	11503632	5906	91
10009923	use#2562	98	10423553	3042	22	11503691	5928	98
10014363	2522	112	10425306	3038	55	11503695	5908	95
10016640	2920	78	10431524	3116	23	11503715	5924	90
10032838	2581	105	10431761	3049	22	11503752	5922	95
10053182	2977	63	10437565	3129	23	11503754	5948	95
10056725	2400	109	10998-3880	2627	61	11503756	5948	95
10060375	5986-disc.-see#3319	93	11296-AG000	3171	56	11503800	5967	91
10063599	2861	42	11500401	5908	95	11503823	5947	92
10077283	2974	54	11500656	5989	90	11503834	5923	92
10077401	2643	42	11500658	5901	90	11503892	2193	77
10093200	2504	39	11500660	5902	90	11503941	5947	92
10098645	3412	27	11500661	5903	90	11503957	5920	90
10109689	2439	76	11500662	5904	90	11503958	5981-disc.-see#5923	92
10121502	2643	42	11500961	5905	91	11503982	5921	92
10125439	3192	73	11500970	5906	91	11504010	2258-disc.-see#2193	77



OEM/W&E CROSS REFERENCE GUIDE

OEM #	W&E #	PG. #	OEM #	W&E #	PG. #	OEM #	W&E #	PG. #
11504056	2322	77	11519444	3023	55	1196781	826	103,111
11504069	2184	84	11519949	2889	53	12001470	3032	133
11504493	5921	92	11546805	3421	28	12013813	3199	134
11504522	3314	84	11547341	3420	28	12040983	2855	120
11504646	2744	84	11561368	3210	57	12040984	2854	120
11504647	2186	84	11561448	see#2675	16	12048369	2846	133
11504655	2187	84	11561491	use#3282	24	12078178	3032	133
11504656	2189	84	11561499	3218	40	12083005	3030	133
11504659	2185	84	11561654	3315	49	12083680	3031	133
11504766	2345	81	11561655	3207	107	12084605	2117	45
11504774	2240	84	11561732	2356	41	12085330	3033	133
11505022	2423	77	11561857	3204	20	12116169	3032	133
11505023	2634	78	11561874	3018	55	12338015	2944	115
11505044	5962	92	11561878	2551	51	12338074	2741	111
11505104	2859	80	11562024	3311	44	12353912	2979	69
11505204	2746	78,84	11562250	3312	24	1247708	2163	14
11505214	5948	95	11562364	3414	27	1264963	2581	105
11505329	5922	95	11562563	3322	24	1304967	2374	104
11505596	5989	90	11562568	3403	26	13252118	3344	50
11506099	5924	90	11569920	3405	25	13252119	3345	50
11507083	2256	77	11569973	use#3278	23	1355003	2338	102
11508241	5924	90	11571159	3342	38	135603	825	103
11508879	2745	84	11571175	3313	24	1370853	2338	102
11508925	5902	90	11588286	3118	80	1377030	2173	103
11509033	5976	92	11588643	3343	65	1379013	836-discontinued	
11509185	2783	86	11588650	3331	16	1383497	836-discontinued	
11509237	2575	81	11589181	3284	44	1385235	836-discontinued	
11509440	3053	92	11589244	3278	23	1395-68-676	2619	61
11509737	2488	86	11589289	3245	56	14003784	5945	96
11509815	3316	78	11589290	3214	57	14005097	2810	112
11513895	2684	78	11589291	3273	58	14005953	2183	112
11514314	2193	77	11589292	3413	27	14007940	2433-discontinued	
11514331	2905	82	11589293	3215	57	14013241	2237	60
11514377	2489	77	11589294	3224	57	14013246	2208	103
11514415	2981	79	11589295	3326	59	14015161	2238-discontinued	
11514845	2489	77	11589296	3327	59	14017705	2430	121
11514970	2859	80	11589329	3381	26	14019205	2216	50
11515425	5980	91	11589330	use#3417	27	14019206	2216	50
11515619	5984-disc.-see#5980	91	11609303	use#3280	23	14022878	2336	15
11515655	3089	93	11609417	3367	59	14032291	2406	104
11515791	5988	91	11609651	3386	26	14045480	2453	51
11515903	5940	93	11609690	2801	37	14063981	2266	76
11515923	5991	94	11609697	3343	65	14066728	2944	115
11516807	3332	72	11609862	3207	107	14070914	2267	76
11516908	3120	93	11609923	3286	24	14071289	2399	50
11517372	3321	94	11610049	3330	31	14074081	2107	40
11517803	3023	55	11610086	3383	26	14093088	2388	50
11518017	3078	55	11610157	3409	27	14093311	1225	40
11518201	3009	43	11610383	3220	73	14103461	2438	51
11518357	3035	22	11610495	3395	25	1484570	175	13
11518755	3317	77	11610605	3344	50	1493541	1034	100
11518988	3280	23	11610606	3345	50	1494253	915	89
11519031	3296	49	1189106	988	122	1494258	916	89
11519032	3299	49	11900338	3121	94	15002520	3081	17



OEM/W&E CROSS REFERENCE GUIDE

OEM #	W&E #	PG. #	OEM #	W&E #	PG. #	OEM #	W&E #	PG. #
1500971	5984-disc.-see #5980	91	15964971	2741	113	20064875	2983	37
15022087	2888	72,99	15964972	2740	113	20085729	2579	69
15025531	2919	31	15967438	3051	79	20130258	2906	112
15056810	3008	43	15967691	2714	114	20136601	2233-discontinued	
15076791	3114	49	15969147	2550	51	20162174	2975	69
15078238	3410	27	15986673	2490	46	20169887	2176	68
15127746	3310	24	15993201	2739	53	20175051	2232	15
15149708	2887	53	15994165	3133	56	20184399	2622	70
15120856	3417	27	15994486	3160	113	20199675	2229	15
15153415	2953	54	1600375	1012	100	20274997	2337-discontinued	
152867	2143	99	1605396	2140	40	20298365	2899	47
15296830	3260	58	1606642	1012	100	20319841	3056	43
154804	2804	82	1616923	2207	32	20325696	3289	73
15505451	2524	112	1619321	2204	40	20345137	2282	113
15506827	2266	76	1624705	146	13	20351035	5923	92
15506921	2266	76	1629341	1212	64	20369894	3002	69
15552345	2107	40	1631564	2356	41	20369895	3003	69
15554088	2110-discontinued		1644290	3170	44	20374473	2462	46
15562609	2740	113	16500308	2413	50	20375022	2293-discontinued	
15562610	2753	116	16502342	3147	110	20413107	2414	32
15591860	2714	114	16504937	2580	102	20421672	2270	76
15594541	2676	65	16505374	2580	102	20421800	2274	45
15599064	2367	41	16506582	2580	102	20423550	2685	82
15600382	2274	45	16508139	2580	102	20429500	2284	113
15607165	2511	46	1654047	355	67	20432975	2264	76
15612948	2511	46	1654048	354	67	20433026	2267	76
15614746	2266	76	16600199	3258	91	20451401	2286	45
15638413	2721	46	16601263	2507	66	20452072	2485	76
1564180	945	94	166066936	2538	66	20465395	2640	76
15653790	2896	115	16606936	2538	66	20478732	2955	69
15676621	2299	41	16630688	2625	66	20487630	2979	69
15681408	3215	57	16632192	2740	113	20510029	2398	50
15682898	3081	17	16632193	2741	113	20514862	2365	41
15683591	5940	93	16656935	2224	45	20538173	2759	32
15685040	2714	114	16674629	3064	43	20570245	2420	51
15685073	2941-discontinued		16675980	2951	66	20582532	2509	66
15686142	2675	16	1699250	2107	40	20582533	2510-discontinued	
15691493	2741	113	1717924	2441	65	20590899	2398	50
15691595	2714	114	171-853-615A	2479	105	20603072	378	67
15709267	3184	98	171-853-695A	2300	18	20612732	2640	76
15715058	2774	70	171-867-299B	2199	45	20625733	2980	98
15732202	2642	76	175-553-577A	2267	76	20664091	2415	60
15733970	2946	31	175720B010	2399	50	20664092	2460	60
15733971	2945	31	175-853-577	2264	76	20699808	2652	32
15762170	3098	44	175-853-695	2237	60	20712172	2979	69
15764320	2919	31	175-853-695A	2238-discontinued		20712176	2979	69
15872008	3282	24	175-867-299	2246	45	20729795	5977	94
15953247	2621	46	179-813-883	2338	102	20732399	1225	40
15955172	2270	76	20028569	2221	15	20734005	2552	46
15958694	2140	40	20032850	2299	41	20747509	2955	69
15959832	2701	52	20033049	3088	91	2088248	2367	41
15960325	2699	52	20036949	2504	39	21030249	2550	51
15963179	2721	46	20043351	2358	114	21035345	2985	54
			20046147	2357	114	21039129	2656	36



OEM/W&E CROSS REFERENCE GUIDE

OEM #	W&E #	PG. #	OEM #	W&E #	PG. #	OEM #	W&E #	PG. #
21042045	2561	39	25655545	3238	80	3691590	2140	40
21042053	2561	39	25665391	3009	43	3691599	1010	100
21042058	2561	39	25693852	3108	23	372820-S36	2330	71
21042104	2561	39	25695687	3132	56	373846-S	2426	121
21075686	2551	51	25722671	3036	22	374684-S32	879	109
21077123	2902	53	25724529	3043	22	3750535	988	122
21077131	2986	54	25744385	3360	21	3751212	2430	121
21077575	2628	32	25796285	3358	23	375203S	2136	75
21094146	2629	42	26022-H1010	2211	102	3783004	825	103
21095797	2757	53	26023-H1000	2212	102	3783005	825	103
21097292	2628	32	2785842	1032-discontinued		378527	use#3424	73
21110201	2629	42	2811852	1290	66	379046-S	818	103,111
2193101	2254	15	2945108	2507	66	379830-S	819	103
22189414	3099	44	2945109	2508	66	380382	2338	102
22508050	2426	121	29818-474D3	2494	105	380614-S	2428	121
22508051	2427	121	2998430	1223	36	380707-S	2295-discontinued	
22512276	2512	42	30006620	2851	47	3816659	2290	120
22514578	2247	104	3065575	2224	45	383003	2427	121
22520368	2810	112	3066259	2280	68	383033-S101	1210	64
22520702	2676	65	3078511	2230	36	383142-S	2104	51
22535007	2437	51	3081052	3012	66	383229-S	2136	75
22543363	2975	69	309414	2682	62	383927S	1222	36
22547243	3383	26	31100005	2200	64	384051-S	1222	36
22569178	2776	71	326177	2254	15	384939-S47	2222	87
22575287	2459	41	332364	1225	40	385189	2121	70
22578214	2775	71	34201347	2443	65	385323-S100	2122	70
22579423	2776	71	34201621	2216	50	385330-S	1224	36
22585836	3027	71	34201631	2266	76	385661S	2367	41
22587036	2729	52	34201681	2246	45	386122S	2214	104
22603384	3044	22	34202599	2455	39	386132-S	2546	120
22641917	3027	71	34202672	2398	50	386132	2546	120
22642007	2786	17	34202787	2356	41	3861577	2299	41
22643056	2774	70	34202855	2264	76	3863669	829	99
22718305	3208	38	342271	2285	112	3868985	2119	100
22718369	3377	50	343541	839	101	387258-S	2299	41
22722859	3218	40	343542	839	101	387477-S	2363	39
22722860	3203	40	343543	1040	101	387496-S	2117	45
23270-30895	2619	61	345220	2505	66	388047-S100	2123	70
24501057	3423	28	345221	2506	66	388047-S102	2452	70
2486468	2457	113	347347	2244	104	3880632	832	102
25016383	2414	32	354076	839	101	388246A	2414	32
2524526	830	99	354076	1040	101	388378	2441	65
25501771	2175	18	355891	875	109	388442-S100	2353	71
25512081	2546	120	357020	2426	121	388577S	2140	40
25524005	2641	76	358470	1213	60	388664-S100	2354	71
25535963	2809	31	363137	2291	45	388904S	2900	42
25601491	2976	43	365266	2116	100	388908-S	2425	36
25606274	2769	16	365270	2116	100	388930-S	2418	41
25609048	3217	73	365270	2124	101	389138	2427	121
25618730	2480	72	3671410	2426	121	389268-S100	2622	70
25630258	2775	71	367292	2183	112	389358S	1225	40
25631448	3091	20	367292	2432	112	3893980	817	103
25640776	2782	78	3673945	2426	121	389443-S	2461	42
25642453	3212	57	3691590	1225	40	3895904	2430	121



OEM/W&E CROSS REFERENCE GUIDE

OEM #	W&E #	PG. #	OEM #	W&E #	PG. #	OEM #	W&E #	PG. #
390428-S100	2750	72	4676356	2799-discontinued		5505125	2635	114
3907444	818	103,111	4696129	2628	32	55055098	2651	18
390964-S	3412	27	4696488	2718	62	55157055-AA	3348	24
391039-S	2418	41	4696963	3007	43	55157065-AA	3348	24
3919773	2244	104	469716	3012	66	55157112-AA	3356	64
3921446	837	101	4717164	2510-discontinued		55157112-AB	3356	64
3960314	943	94	4717165	2509	66	55074801	2453	51
3977775	usc#2230	36	472450	2442	65	55176248	2388	50
3986976	2109	22	4755299	826	103,111	554459	1024	99
3986978	844	102	4759514AB	3025	106	555388	1024	99
3986997	944	94	47749-50090	3290	31	556196	1011	100
4001934	2993	38	47749-58010	3234	29	556359	1011	100
4003672	2507	66	480534	1222	36	557057	1011	100
4003673	2508	66	4805405AA	2932	54	560625	2427	121
4003717	2110-discontinued		4805770AA	3065	16	56901-S2	2325	81
4004569	2140	40	4806226AA	3414	27	56902-S2	2227	81
4004919	2140	40	4806334AA	3263	58	56902-S2	2585	81
4005099	2707	46	4857108	3212	57	56903-S2	3256	81
4005470	2105	45	4857345AA	3187	56	56904-S2	2345	81
4005540	353	67	4876498	1206	32	56912-S2	2787	81
4006316	2245	109	4878883AA	2927	37	56915-S2	2788-disc.-see#2586	81
4006516	2414	32	4883164	351	14	56916-S2	2586	81
407217	945	94	5113-1816-019	2310	15	57728AC060	2609	61
4103165	2443	65	5113-1849-724	2311	15	57728AC090	3040	55
4104998	2427	121	5113-1869-559	2308	15	57728FA020	2609	61
4114785	1212	64	5113-6440-146	2303	15	58974-00008	2408	17
411700	2108	40	5116530AA	3260	58	5970995	2522	112
411846	841-discontinued		5118-1852-299	2305	104	5973400	2223	50
411847	842	99	5147-1-840-961	2306	15	5973823	2351-disc.-see#2438	51
411-853-575	2303	15	5183468AA	2809	31	5FR56DX9	2892	17
4200408	5965	95	52009077	2752	37	5R3Z-54310D12-BAA	3365	44
4216535	2237	60	5201269	2119	100	600020	875	109
4234830	2273	66	5201359	2119	100	6000558	878	109
4280727	2635	114	52161-02020	2885	53	6000752	879	109
4280729	2600	116	52161-16010	2885	53	6002092	2402	13
4336115	2637	113	52161-20010	3235	57	6003349	2105	45
4341060	2957	37	52535-50060	3264	108	6003351	1224	36
4370132	2267	76	52575-30180	3294	21	6003518	2110-discontinued	
4370138	2653	76	53326-52010	3366	16	6003575	2141-discontinued	
4381385	2900	42	53455-14020	2767	65	6003632	2142	14
4388249	2456	101	53857-47011	3384	30	6003654	2190	45
4422660	384	67	53867-47020	3337	30	6004212	2640	76
4474354	384	67	53879-14010A	2496	29	6010082	815	103
4492962	341	14	53879-14020	2496	29	6010093	146	13
4506041	385	67	53879-16010	3292	29	6013122	2899	47
45263-S2	910	89	53879-17020	3292	29	6015149	988	122
45264-S2	915	89	53879-22010	2495	29	6015930	2129	120
45269	917	89	53879-22030	2496	29	6023168	2926	89
4533669	385	67	53879-30040	3418	31	6025334	2747	94
4630088	2642	76	53879-50020	3291	31	6026647	1051	96
4630253	2717	52	53879-58010	3233	29	6026648	1050	96
4630660	2642	76	53879-60010	3232	57	6026686	929	97
4658673	2848	33	547609	2929	75	6027941	2272	112
4658676	2625	66	5480852	3309	24	6028993	2360	114



OEM/W&E CROSS REFERENCE GUIDE

OEM #	W&E #	PG. #	OEM #	W&E #	PG. #	OEM #	W&E #	PG. #
6029501	2338	102	6500626	5936	90	6505539AA	2939	47
6030441	2140	40	6500787	2413	50	6505686AA	3008	43
6030519	2101	103	6500859	2264	76	6505703AA	3026	106
6030539	2222	87	6500898	2265	76	6505918AA	3046	48
6031091	2122	70	6500899	2264	76	6506007AA	2485	76
6031115	2121	70	6500911	2266	76	6506008AA	2887	53
6031138	2210	103	6501067	2407	41	6506132AA	3244	58
6031234	2210	103	6501086	2900	42	6506293AA	see 2900	42
6031321	1225	40	6501178	5961	96	6506788	3208	38
6031438	2432	112	6501301	2629	42	6507557AA	2414	32
6031869	2581	105	6501352	2560	65	6507866AA	3185	21
6032138	2321	71	6501559	2485	76	6508197AA	3274	63
6032268	2676	65	6501590	2458	51	6508712AA	3210	57
6032723	2345	81	6501792	5961	96	6508863AA	3245	58
6032881	2353	71	6501916	3383	26	6509049AA	3214	57
6032899	2805	82	6501925	2398	50	65810-K2000	3094	35
6032975	2360	114	6502328	2652	32	65832-F5000	2583	36
6033006	2519	86	6502573	2719	62	65846-30F00	2583	36
6033018	3097	44	6502586	2459	41	65846-40F00	2967	37
6033801	2514	77	6502625	2682	62	65846-4Z-000	2967	37
6033862	2707	46	6502776	2784	17	66435-648-000F	2964	35
6034212	3190	73	6502790	2460	60	66824-01G00	2617	52
6034703	2666-discontinued		6502842	2656	36	66860-01W01	2592	61
6034912	3236	84	6502871	2460	60	67771-01010	2375	45
6035188	2666-discontinued		6502907	2727	47	67771-03020	2416	46
6035201	2630	72	6502991	2726	46	67771-03030	2417	46
6035296	2406	104	6503106	2912	54	67771-06070	2893	47
6035401	3271	108	6503108	2720	105	67771-12010	2375	45
6036042AA	2879	109	6503163	2977	63	67771-12040	2851	47
61A-1808-0019	2210	103	6503204	2849	47	67771-12050	2851	47
6100040	5989	90	6503274	2752	37	67771-22010	2375	45
6100049	5948	95	6503336	2649	19	67771-32120	3378	45
6100568	5968	93	6503339	2650	19	6773-0E020	3394	25
6104908AA	2759	32	6503401	3091	20	67867-12150	3100	33
62228-61A00	2607	65	6503454	2216	50	67868-02020	3100	33
622A2-9E000	3018	55	6503598	2550	51	68003844AA	3215	57
62318-01W00	2368	18	6503709	2760	39	68061648AA	3318	49
62318-H8500	2369	18	6503819	3091	20	68213168AA	3397	18
62581-14020	2962	47	6503860	2653	76	68225214AA	3420	28
6270163	2279	41	6503943	3064	43	6825-H 5000	2339	104
6271989	2357	114	6503971	2752	37	68814-01G00	2612	52
6272766	2426	121	6504014	2727	47	69293-30030	3335	67
6294015	3029	133	6504043	2644	42	73862-672-0030	2766	32
6298935	3029	133	6504090	2216	50	75315-S9A-004	3350	18
6384401 A00	2361	60	6504098	2801	37	75315-STK-A01	see 3350	18
63848-01G00	2615	52	6504135	3058	38	75316-S9A-004	3351	18
63848-35F00	2911	29	6504452	2727	47	75392-04010	3262	21
63848-9Y000	3375	31	6504521	2931	54	75392-35200	3262	21
63848-D0100	2582	29	6505049AA	2982	109	75395-33030	3368	16
63848-D4000	2910	29	6505145AA	3401	91	75395-35070	3188	30
63876-D5596	2491	61	6505292AA	2864	47	75396-35020	3186	30
6500165	5931	95	6505302AA	3005	43	75397-35010	3188	30
6500361	2359	114	6505403AA	2140	40	75495-35010	see 3186	30
6500369	5932	92	6505417AA	3098	44	75522-611-0000	2236	104



OEM/W&E CROSS REFERENCE GUIDE

OEM #	W&E #	PG. #	OEM #	W&E #	PG. #	OEM #	W&E #	PG. #
75775-41300	2619	61	8934201681	2246	45	90467-05090-B1	3287	64
75867-06030	3382	60	8941340270	2963	106	90467-05125	3293	44
75867AA010	3017	48	8941690750	2619	61	90467-06017-20	2366	60
75868AA020	3017	48	89421-76980	2492	39	90467-06161-01	2961	35
76222-SP1-003	3388	25	89421-80270	2408	17	90467-07043	2614	52
76334583	386	67	8942264920	2375	45	90467-07045-22	3061	19
7642589	2993	38	8942431900	2619	61	90467-07050	2379	32
76882-0M000	3172	27	8942981190	2627	61	90467-07076-CO	2991	55
76906-T3000	2492	39	90080-46010	2523	35	90467-07117	3216	57
7698976	390	68	90084-46020	3191	21	90467-07164	3304	59
7730788	389	68	90084-54011	3206	65	90467-07166	2958	54
7731589	345	14	90084-54012	3209	65	90467-07188	3362	60
796255	2707	46	90106-SW3-003	2970	106	90467-07201	3295	59
803-353-577	2301	15	90107-SX0-003	2969	106	90467-07211	3254	58
80406-V5002	2638	115	90108-SW3-003	2968	20	90467-07214	3285	59
80410-01G00	2639	113	90157-SP0-901	3082	19	90467-08004	2523	35
807389S	2550	51	90183-03001	2387	65	90467-08011	2523	35
80833-S5000	2618	32	90189-04008	2381	104	90467-08136	3336	35
80915-29A66	2619	61	90189-04013	2473	104	90467-08180	3242	58
809905N07	2614	52	90189-04033	2502	105	90467-08184	3060	19
81126-37010	3231	38	90189-04042	2236	104	90467-08186CO	3297	44
81127-01010	2611	102	90189-04059	3333	108	90467-08217 use	2889	53
81131-12150	2211	102	90189-04207	3380	26	90467-09006	2972	37
81131-89103	2610	102	90189-04229	3333	108	90467-09008	2493	36
81132-32121	2611	102	90189-05012	2963	106	90467-09050	2913	37
82315-38000	3270	48	90189-05013	2248	102	90467-09069-06	2492	39
823-867-299	2199	45	90189-05105	3062	107	90467-09093	2686	62
8545-50-786	2768	105	90189-05142	3237	102	90467-09145	2655	61
86590-28000	3277	64	90189-06001	2277	104	90467-09166	3241	63
8717859	373	67	90189-06006	2965	106	90467-09212	3361	31
8727925	2221	15	90189-06010	2503	105	90467-10161	2851	47
8731909	see#2964	35	90189-06013	2494	105	90467-10161A	2851	47
8733059	341	14	90189-06028	3063	107	90467-10183	3308	60
8736586	389	68	90189-06042	2374	104	90467-10188	3095	49
8736588	384	67	90189-06065	2494	105	90467-11100	3301	30
8736589	384	67	90189-06131	3340	89	90467-13008	2370	17
8736590	384	67	90189-06157	3146	107	90467-17004	2578	18
87756-35000	3268	108	90189-06177	3334	108	90467-A0002	3297	44
87756-38000	3266	23	90189-06193	3281	108	90467-A0003	2913	37
87756-3D000	3269	18	90189-06211	3339	108	90467-A0005	3228	49
87758-3D000	3265	23	90189-06220	3302	108	90467-A0008	3261	44
8799350	2165	15	90189-A0002	3302	108	90468-04030	2440	65
88970767	3308	60	90269-04006	3247	74	90505-SM4-003	2613	61
8901283	3029	133	90269-04050	3248	74	90505-SX0-003	3194	56
8911472	2219	120	90269-04051	3249	74	90601-SMG-003	3429	28
8911497	2289	120	90269-04053	3250	74	90602-S7S-0030	3176	20
8917320	2290	120	90269-05054	3251	74	90602-SXO-0030	3173	20
8918527	3029	133	90269-05065	3252	74	90603-S7S-0030	3177	20
8919916	3199	134	90269-06013	3253	74	90603-SX0-0030	3174	20
893202-599	2455	39	90269-A0006	3249	74	90651-689-0030	2378	17
8934201293	2524	112	90303-SXO-0030	3174	20	90651-689-9000	2378	17
8934201602	2581	105	90467-04009	2894	29	90652-SB2-023	3080	66
8934201621	2216	50	90467-04034	3303	34	90657-SA5-003	2366	60
8934201631	2266	76	90467-05063-C0	3347	64	90657-SA6-0030	2716	62



OEM/W&E CROSS REFERENCE GUIDE

OEM #	W&E #	PG. #	OEM #	W&E #	PG. #	OEM #	W&E #	PG. #
90657-SB0-0030	3019	55	91503-SZ5-003	2898	53	9433155	2255	89
90661-SC7-0030	2374	104	91503-T2A-A01	3389	21	9433159	2708	89
90662-671-0030	2339	104	91504-SM4-0000	2549	61	943355	2271	86
90664-671-0030	2618	32	91504-SP1-003	3390	25	9436165	2482	85
90666-SDA-A01	3430	28	91505-S9A-0032	3202	56	9436175	2121	70
90670-SG0-003	3072	107	91505-ST7-003ZA	3242	58	9437552	2563	70
90672-SA0-0030	2497	122	91505-TM8-0030	3371	60	9437938	2122	70
90674-692-0030	2376	68	91506-S9A-003	3246	58	9439719	3288	73
90674-SA6-0030	2371	68	91507-S84-A11	2971	35	9442361	3217	73
90675-SB0-003	2491	61	91508-SM4-003	3079	55	94530585	3270	48
90675-SB3-003	2491	61	91510-SR3-003	2960	17	94841130	2381	104
90676-671-0030	2372	20	91512-S50-003	3391	25	94841226	2496	29
90678-SA0-003	2478	51	91512-SE0-003	2956	66	94854203	3063	107
90682-SB0-003	3073	107	91512-SM4-003	2758	62	95005064	2375	45
90682-SDA-A01	3354	108	91512-STK-A01	3427	28	95008221	2851	47
90682-SEA-003	3355	30	91512-SX0-003	2889	53	95900-04036	2236	104
90684-SA5-0030	2627	61	91513-SJK-003	3426	28	95900-08025	2611	102
90686-SB0-0030	2502	105	91513-SMG-E11	3352	31	96057846	2991	55
90687-671-0030	2373	39	91513-SM4-000	3074	23	9616231	2222	87
90687-SA5-0030	2379	32	91516-SK7-003	3434		9617200	2127	14
90688-SB0-003	2475	61	91516-SK7-013	3434		96185-6006	3092	107
90700-SB2-003	3083	38	91516-SM4-003	3075	33	9662950	378	67
90700-SJ4-000	2973	37	91518-S10-003	2687	35	96706-B0700	2236	104
90814-FC001	3363	38	91518-SM4-003	2966	35	96706-H2500	2539	105
90853-670-003	2478	51	91520-SM4-C010	2687	35	96706-H940	2502	105
90904-67036	3077	30	91528-S01-A01	3150	17	96706-P0105	2503	105
90904-67037	3076	30	91528-SR4-003	3150	17	96706-U0100	2277	104
90913-0051	3398	64	91530-SP1-003	2844	32	96706-W100	2494	105
90913-0074	3305	38	91530-ST5-003	3075	33	9685057	2105	45
90913-0088	3399	25	91533-SG0-0000	3019	55	96FG16K262AA	2942	63
90914-0007	3306	59	91534-SE0-000	2633	16	9711304	2273	66
90914-0055	3359	64	91545-SE0-0030-W1	2615	52	9716926	2282	113
90914-0059	3307	59	91558-SE3-003	3328	66	9721917	2281	113
90914-0062	3432		91560-SLJ-J01	3353	45	9731301	353	67
91500-SM4-999A	3090	111	91560-S84A-A01	3004	48	979878-6	3298	73
91501-S1K-0030	3119	38	91561-S84-A00-M1	2897	62	9808241	371	67
91501-SEA-0030	see 3267	30	91561-S84-A01-M1	3055	17	9818648	1205	45
91501-SG0-003	2632	16	91561-SJD-003	3275	58	9822198	2283	113
91501-SL4-033	3387	20	91566-SP0-003	3364	44	9854717	373	67
91501-SM4-003	2598	19	91568-SR2-003	2844	32	9883583	1205	45
91501-SNA-0030	3267	30	91578-SW5-003	3393	21	9895598	379	67
91501-SO4-003	2886	53	91578-T0A-003	3393	21	9926-40-658	2492	39
91501-STK0030	3119	38	91619-SA5-003	2503	105	9926-50-625	2366	60
91501-SWA-003	3374	37	91626-SH3-003	3072	107	9926-50-635	2619	61
91501-TA0-0000	3305	38	91635-SM4-003	2608	18	9927-40-822	2962	47
91501-TR0-003	3372	60	93904-46320	3090	111	9927-40-825	2375	45
91502-S84-A11	2971	35	9415191	2520	86	9928-90-753	use#2497	122
91502-S9A-003	3349	30	9417855	2803	86	9928-91-053	2497	122
91502-SM4-0000	2548	61	9422202	2665	81	9928-91-353	2497	122
91502-SP0-003	2884	62	9423101	2895	110	9991-00-412	2236	104
91503-S0K-A01	3229	57	9428738	2345	81	9991-00-503	2339	104
91503-S7A-003	2883	53	9431995	2743	82	B033-68-805	2502	105
91503-SP0-0030	2609	61	9432137	2321	71	B37F-50B11	3225	29
91503-SZ3-003	2883	53	9432552	2537	75	B4555-6135	3225	29



OEM/W&E CROSS REFERENCE GUIDE

OEM #	W&E #	PG. #	OEM #	W&E #	PG.#	OEM #	W&E #	PG. #
BC1D-56-145	3226	63	FB01-56-964	2491	61	N803946S	2415	60
BF-82-50-233	2624	61	G032-68-865A	3365	44	N804193-S100	2728	70
BP4K-58-762	3341	35	H001-50-841	2374	104	N804344S	2508	66
C5ZZ-6542413-B	387	67	J308105	2752	37	N804349S	2459	41
D1AB-6542413-AB	387	67	KA01500Z1	2266	76	N804379S	2356	41
D20B-6522841A	2327	113	L33X13209	3346	60	N804472-S	use 2485	76
D3AB-138093-AC	1025	100	LA01-56-135	2496	29	N804523-S	3217	73
D3AZ-13410-D	3213	134	MB029-111	2381	104	N804570S	2460	60
D3HB-13A093-AB	2118-discont.		MB-098145	2277	104	N804583S	2355	76
D40Z-13410E	3029	133	MB-106212	2502	105	N804614S	2420	51
D40ZZ-13410-E	3213	134	MR-181745	3396	26	N804675S	2653	76
D4LY-13410-A	3034	134	MR-200300	3109	56	N804765-S	2866	106
D4SZ-13410-E	3213	134	MS-480001	2236	104	N804837S	2882	62
D4ZZ-13031A	2178	99	MS-480002	2248	102	N804851-S100	2852	72
D5AB-7120818-A	2110-discont.		MU000319	2889	53	N804863S	2264	76
D5UB13B-160-AA	2383	99	N 143893	2200	64	N805026S	2718	62
D5UB2220232AA	358-discont.		N304-13-356A	2716	62	N805155S	2760	39
D5UZ-13031-A	2179	99	N606624-S191	2784	17	N805350S	2507	66
D7AZ-134112-A	3029	133	N606676-S2	5963	93	N805592-S100	2480	72
D7FZ-13412-A	3029	133	N606677-S36	5952	92	N805612S	2455	39
D8BB-13A093AB	2144	100	N621901-S36	5975	95	N805759-S100	2688	72,75
D9AZ-54234A46-AA	2954	69	N621903	5965	95	N805940S	2422	120
D9BB-5402316-AA	2445-discont.		N621907-S55	5983	95	N806088-S58	3101	79
D9OZ-6522841A	2327	113	N621940	5908	95	N806113-S	3064	43
D9ZZ-6643030-AA	3161	116	N623331-S2	5989	90	N806334-S	3020	106
E0SZ-154A442B	3032	133	N623332	5920	90	N806624-S19	2784	17
E1EB-13A093AA	2235	101	N623333-S100	5902	90	N806830-S100	2630	72
E1TB-13A093AA	2235	101	N623333-S2	5902	90	N807389-S	2550	51
E25-13B1600AA	840	99	N800369-S2	2446	110	N807438-S	2844	32
E3DB-13A093AF	2268	101	N800503S	2213	103	N807572-S	3084	111
E3DB-14A163CA	2216	50	N800744S	5945	96	N807620-S100	3190	73
E3DZ-13032A	2268	101	N801192S36	5961	96	N807706-S	2850	105
E3DZ-13032C	2268	101	N801603-S2-disc.-see#3257		80	N807721-S	2644	42
E3SB-6342413AB	2298	68	N801925S	2364	39	N807872-S32B	2780	17
E7ZB6120908AC	2419	16	N802224-S	2900	42	N807994-S	2756	105
E8PZ-13411A	3195	134	N802376-S	3021	106	N808426-S100	2858	72
E8PZ-13411B	3196	134	N802538-S301	2751	89	N808592-S100	3110	79
E8PZ-13411C	3197	134	N802734-S	3208	38	N808842-S	2801	37
E8PZ-13411D	3198	134	N802781S	2388	50	N811040-S	3205	35
E8UZ1522840	2943	115	N802900	2364	39	N811169-S	3022	106
E9DB-13A093-A	2535	101	N802900S	2561	39	N811283-S	3113	63
E9DB-13N020-AA	2534	102	N803043S	2266	76	N811772-S	2810	112
E9DB-14A-163CA	3066	121	N803138-S	3217	73	N811849-S300	2937	19
E9DZ-13032-A	2535	101	N803362	2398	50	N900-845-01	3219	73
E9DZ-13N129-A	2534	102	N803387-S300	3005	43	N90100001	5922	95
E9VB5420884AA	2421	14,16	N803421S	2458	51	N989022	2367	41
F24B-13A093-BA	2535	101	N803494S	2405	60	N98905101	2105	45
F2B-13N020-AA	2534	102	N803678-S	3097	44	W503925-S36	3054	93
F37-13N129A	2700	102	N803709	3212	57	W504260	2781	83
F3LY-14570-B	2551	51	N803739-S	3425	28	W505416	3319	93
F57Z-16241-AB	3325	24	N803749-S32B	2676	65	W505435	3320	94
F58B-16237A02-AB	2785	39	N803862S	2485	76	W525170-S417	2890	71
F6DZ-5402316-AA	2935	19	N803933-S101	2749	72	W525172-S417	2891	71
F7DB-5402316-AA	2935	19	N803934S	2420	51	W610713-S300	3245	58



OEM/W&E CROSS REFERENCE GUIDE

OEM #	W&E	PG. #	OEM #	W&E	PG.#	OEM #	W&E #	PG. #
W700158-S300	2683	105	W713579-S300	3392	99			
W700505-S300	2681	105	W713610-S300	3245	58			
W700548-S300	2679	32	W714040-S300	3214	57			
W700671-S300	2678	37	W714415-S300	3260	58			
W701054-S300	2420	51	W714584-S300	3411	27			
W701380SSW	2680	42	W716350-S300	3406	25			
W701430S300	2677	39	W716351-S300	3419	27			
W701649-S	2936	19	W716460-S300	3415	27			
W7016505	2935	19	W716503-S300	3407	25			
W701855-S300	3006	43	W716510-S300	3408	26			
W703069-S300	2947	106	W717736-S300	3428	28			
W704340-S300	2388	50	W717823-S300	3431	52			
W704342-S300	2485	76	XL34-17E971-AA	2987	55			
W704643	2844	32	XL3Z-17E971-AA	2987	55			
W704740S300	2756	105						
W704881-S300	2936	19						
W704958-S300	3182	56						
W705002-S300	2801	37						
W705436-S300	2902	53						
W705550-S300	3022	106						
W705581-S300	2413	50						
W705589-S300	2140	40						
W705848-S300	2460	60						
W706092-S300	3274	63						
W706264-S300	2977	63						
W706350-S300	2415	60						
W706494-S300	3112	63						
W706713-S300	3013	63						
W707484-S900	3050	79						
W707889-S300	2992	43						
W708035-S300	3131	21						
W708045-S300	3130	21						
W708088-S300	3014	33						
W708325-S300	2682	62						
W708530-S300	3078	55						
W708633-S300	3404	26						
W708771-S300	3370	16						
W709154-S300	3098	44						
W709176-S300	2887	53						
W709346-S300	2643	42						
W709629-S300	3130	21						
W709767-S300	3325	24						
W709883-S300	2993	38						
W710441-S	3111	79						
W710250-S300	3369	59						
W710921-S900	3257	80						
W711031-S300	3402	109						
W711687-S300	3284	44						
W712196-S300	3215	57						
W712665-S300	3326	59						
W712916-S300	3215	57						
W712991-S300	2640	76						
W713297-S300	3230	49						
W713331-S300	3273	58						



WEE PAK RAK #1 PARTS LISTING BY PANEL- NUMERICAL ORDER

<u>GREEN PANEL</u>	<u>BLACK PANEL</u>	<u>RED PANEL</u>	<u>BLUE PANEL</u>
99-146	99-817	99-1225	99-2547
99-147	99-818	99-1262	99-2548
99-150	99-819	99-1651	99-2549
99-156	99-822	99-1652	99-2550
99-161	99-826	99-1653	99-2609
99-341	99-837	99-1659	99-2615
99-345	99-846	99-2104	99-2618
99-349	99-858	99-2105	99-2623
99-351	99-860	99-2107	99-2643
99-353	99-875	99-2108	99-2644
99-373	99-878	99-2117	99-2653
99-378	99-879	99-2131	99-2656
99-385	99-887	99-2140	99-2687
99-387	99-910	99-2165	99-2688
99-389	99-911	99-2193	99-2758
99-537	99-915	99-2203	99-2884
99-598	99-916	99-2204	99-2885
99-599	99-917	99-2208	99-2886
99-625	99-921	99-2216	99-2889
99-634	99-922	99-2219	99-2902
99-635	99-940	99-2223	99-2958
99-637	99-942	99-2224	99-2959
99-640	99-943	99-2230	99-2966
99-656	99-945	99-2264	99-2992
99-672	99-951	99-2265	99-3040
99-675	99-963	99-2266	99-3063
99-682	99-965	99-2267	99-3109
99-728	99-966	99-2322	99-5901
99-732	99-972	99-2354	99-5902
99-740	99-1011	99-2413	99-5903
99-777	99-1205	99-2414	99-5905
99-797	99-1212	99-2423	99-5906
99-798	99-1213	99-2439	99-5920
99-799	99-1223	99-2480	99-5921
99-811	99-1224	99-2485	99-5922
99-815	99-2245	99-2528	99-5923



WEE PAK RAK #2 PARTS LISTING BY PANEL- NUMERICAL ORDER

<u>GREEN PANEL</u>	<u>BLACK PANEL</u>	<u>RED PANEL</u>	<u>BLUE PANEL</u>
99-636	99-2290	99-2420	99-2613
99-674	99-2296	99-2425	99-2614
99-920	99-2297	99-2449	99-2628
99-923	99-2320	99-2453	99-2629
99-928	99-2324	99-2455	99-2641
99-971	99-2338	99-2458	99-2652
99-1206	99-2339	99-2460	99-2699
99-1210	99-2345	99-2461	99-2727
99-2147	99-2347	99-2462	99-2739
99-2148	99-2351	99-2465	99-2757
99-2164	99-2356	99-2466	99-2759
99-2183	99-2357	99-2467	99-2844
99-2207	99-2361	99-2468	99-2845
99-2222	99-2363	99-2473	99-2883
99-2226	99-2364	99-2475	99-2887
99-2227	99-2365	99-2477	99-2898
99-2229	99-2366	99-2490	99-2913
99-2236	99-2367	99-2491	99-2927
99-2244	99-2369	99-2492	99-2931
99-2248	99-2370	99-2493	99-2933
99-2255	99-2373	99-2494	99-2953
99-2256	99-2374	99-2503	99-2973
99-2259	99-2375	99-2505	99-3006
99-2270	99-2379	99-2506	99-3075
99-2273	99-2382	99-2507	99-3076
99-2274	99-2387	99-2508	99-3077
99-2277	99-2388	99-2509	99-3078
99-2278	99-2398	99-2510	99-3093
99-2279	99-2399	99-2511	99-3146
99-2281	99-2407	99-2512	99-3171
99-2282	99-2408	99-2522	99-5904
99-2283	99-2415	99-2523	99-5914
99-2284	99-2416	99-2526	99-5915
99-2286	99-2417	99-2529	99-5916
99-2289	99-2418	99-2551	99-5924
99-5946	99-2974	99-2599	99-5925

PARTS LISTING-MINI CHARTS

PARTS LISTING-W & E MINI CHARTS

<u>MC-1</u>	<u>MC-2</u>	<u>MC-3</u>	<u>MC-4</u>	<u>MC-5</u>
1225	2361	146	915	811
2140	2366	150	916	965
2204	2398	440	942	966
2230	2399	441	943	1220
2347	2415	818	4201	2121
2356	2420	2216	4202	2122
2364	2460	2223	4203	2123
2379	2491	2264	5901	2138
2407	2548	2265	5902	2139
2414	2550	2266	5903	2162
2418	2551	2267	5904	2193
2459	2599	2270	5906	2203
2461	2609	2385	5908	2222
2493	2613	2386	5909	2226
2512	2615	2388	5910	2255
2523	2686	2439	5911	2256
2618	2739	2453	5920	2322
2628	2758	2485	5921	2340
2629	2883	2494	5922	2345
2643	2884	2496	5923	2354
2644	2885	2497	5924	2409
2652	2886	2641	5931	2423
2656	2887	2653	5938	2448
2687	2889	2748	5940	2452
2844	2898	2771	5941	2480
2913	2902	2811	5947	2622
2933	2931	2812	5948	2630
2966	2958	2901	5952	2634
2972	2959	2953	5955	2688
2973	3040	3063	5962	2777
2992	3078	3093	5963	2778
3076	3109	3146	5965	2921

SALES AIDS

W & E MINI CHARTS

11" X 17" WALL CHARTS CONTAINING
 32 POPULAR W & E ITEMS PER CHART (FOR PARTS LISTING SEE PG.184)
 LISTED BY PRODUCT CATEGORY
 IDEAL FOR QUICK REFERENCE ON ESSENTIAL BODY SHOP FASTENERS
UPDATED REGULARLY
TO INCLUDE FAST SELLING NEW ITEMS



AUTO BODY FASTENERS

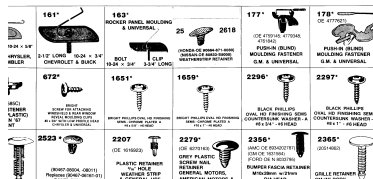

- MC-1
- MC-2
- MC-3
- MC-4
- MC-5

PLASTIC CHRISTMAS TREE, WEATHERSTRIP & HOOD CLIPS

PLASTIC SCREW RIVETS AND PUSH TYPE RIVETS

MOULDING BOLTS, TERMINALS, GROMMETS, MISC. RETAINERS

METRIC & STANDARD BOLTS, NUTS, SPEED NUTS, FLANGE NUTS

SPECIAL SCREWS, CLIP NUTS, RIVETS, SHIMS & HOG RINGS

EACH UNIT PKG.-1

WECD



CURRENT CATALOG ON CD

THE COMPLETE UP-TO-DATE VERSION OF THE W&E CATALOG IS AVAILABLE ON CD ROM. BROWSE BY PAGE OR USE OUR LINK FROM THE TABLE OF CONTENTS OR PRODUCT INDEX TO ACCESS SPECIFIC PART NUMBERS. SEARCH BY DESCRIPTION OR TYPE OF PART IN PLAIN ENGLISH! FOR ADDITIONAL INFORMATION OR WITH ANY QUESTIONS PLEASE CONTACT US OR YOUR W&E DISTRIBUTOR.

UNIT PKG.-1

BL-150 BIN LABELS



EACH SET CONSISTS OF ONE LABEL EACH OF 150 POPULAR W&E AUTOBODY CLIPS AND FASTENERS- PEEL OFF TYPE LABEL INCLUDES: PART #, DESCRIPTION AND PICTURE OF ITEM

UNIT PKG.-1 SET



SALES AIDS

DISP-1



THE W&E DISPLAY CASE - OUR MOST POPULAR AND PROVEN SALES TOOL! SET OF SIX PANELS CONTAINING SAMPLES OF VIRTUALLY EVERY PART IN THE W&E CATALOG. PARTS ARE ATTRACTIVELY DISPLAYED ON METAL PANELS AND MOUNTED IN A DURABLE CARRY CASE.

UNIT PKG.-1

DISP-3

SET OF DISPLAY PANELS ONLY FROM DISP-1 DISPLAY CASE; SUITABLE FOR WALL MOUNTING

UNIT PKG.-1 SET







NEW ITEMS BULLETIN NO. 85

370 ELIZABETH AVENUE, NEWARK, NJ 07112
(973) 824-2000 FAX (973) 824-7382

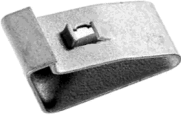
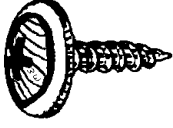
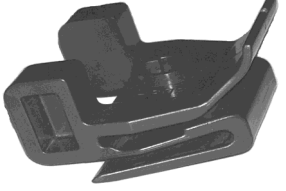
www.wesales.com

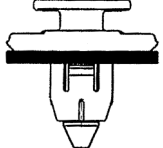
DECEMBER, 2016

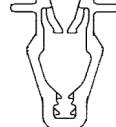
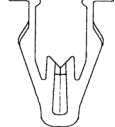
<p>3414</p>  <p>(4806226-AA; 11562364) METAL RETAINER - GRILLE, BUMPER COVER & SKID PLATE (FOR #6 SCREW; 10 MM WIDE X 18 MM LONG) ZINC PLATED (500HR.SALT SPRAY TOL.) CHRYSLER-300, DODGE-NITRO/ CHARGER, JEEP COMMANDO, GM, BUICK, CHEV.-P/U/SUV'S, CAMARO, & CORVETTE 2005-UP</p> <p>UNIT PKG.-15</p>	<p>3416</p>  <p>M5-2.12 X 20 MM PHILLIPS TRUSS HEAD SCREW WITH 16 MM LOOSE WASHER</p> <p>BLACK/ZINC</p> <p>JAPANESE CARS & UNIVERSAL</p> <p>UNIT PKG.-25</p>	<p>3418</p>  <p>(53879-30040) PLASTIC RETAINER FRONT BUMPER COVER & FENDER LINER (USE WITH W&E #3290) (OUTSIDE DIMENSIONS 33X40 MM) TOYOTA/LEXUS- AVALON, CAMRY, GS, ES, & RX 350/HP 2013-UP</p> <p>UNIT PKG.-5</p>
<p>3425</p>  <p>(N803739-S) BLACK NYLON BLIND SEALING RIVET (HOLE DIAM. 6.3 MM(1/4"); PANEL RANGE 0.70-2MM(1/32-5/64"); HEAD DIAM. 18 MM(45/64")</p> <p>FORD TRUCKS & VANS, MERCURY TOPAZ & MOUNTAINEER 1988-2014</p> <p>UNIT PKG.-25</p>	<p>3426</p>  <p>(91513-SJK-003) PLASTIC MOULDING RETAINER WITH SEALER- ROCKER, PILLAR, SPOILER, & TAILGATE (FOR 8.5 MM HOLE; 20 MM HEAD FLANGE DIAM.; 13 MM STEM LENGTH)</p> <p>HONDA-ACCORD, CR-V CIVIC,ELEMENT, & PILOT; ACURA- MDX, RDX, RLX & TSA 2007-UP</p> <p>UNIT PKG.-15</p>	<p>3427</p>  <p>(91512-STK-A01) PLASTIC MOULDING RETAINER WITH SEALER TAILGATE MOULDING (FOR 8.5 MM HOLE; 13 MM TOP HEAD; 20 MM FLANGE; 20 MM OVERALL LENGTH)</p> <p>HONDA-CR-V,ACCORD,ODYSSEY ACURA- RDX & TSX 2011-UP</p> <p>UNIT PKG.-10</p>
<p>3428</p>  <p>(W717736-S300) PLASTIC WHEEL OPENING MOULDING RETAINER (FOR 9 MM HOLE; TOP HEAD 14X20 MM; BOTTOM HEAD 14X18 MM; 25 MM OVERALL LENGTH)</p> <p>FORD F-150 2015-UP</p> <p>UNIT PKG.-10</p>	<p>3429</p>  <p>(90601-SMG-003) PLASTIC BUMPER COVER RETAINER (FOR 7X13 MM HOLE; 13X18 MM OVERALL DIMENSIONS)</p> <p>HONDA CR-V 2015-UP</p> <p>UNIT PKG.-25</p>	<p>3430</p>  <p>(90666-SDA-A01) PLASTIC RETAINER GRILLE & INTERIOR TRIM (FOR 7X13 MM HOLE; 11X17 MM OVERALL DIMENSIONS)</p> <p>HONDA-ACCORD, CIVIC & CR-V 2003-UP</p> <p>UNIT PKG.-25</p>

3431

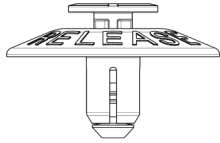

(W717823-S300)

**PLASTIC PUSH RIVET
FENDER LINER RETAINER**

**(FOR 6.5 MM HOLE; 25 MM FLANGE
DIAM.; 9 MM STEM LENGTH)**

**FORD- MUSTANG
2015-UP**

UNIT PKG.-15

3432



(90914-0062)

**PLASTIC PUSH RIVET
BUMPER COVER RETAINER**

**(FOR 7 MM HOLE; 15MM O.D.
HEAD.; 11 MM STEM LENGTH)**

**SUBARU FORESTER, LEGACY,
OUTBACK, BRZ, WRX & XV
CROSSTEK
2008-UP**

UNIT PKG.-15

3433



(01553-08961)

**HOOD SEAL AND DOOR
WEATHERSTRIP RETAINER**

**(FOR 5 MM HOLE; 10 MM HEAD
DIAM.; 8 MM STEM LENGTH)**

**NISSAN- ALTIMA, LEAF &
MURANO/ INFINITY G37
2007-UP**

UNIT PKG.-25

3437

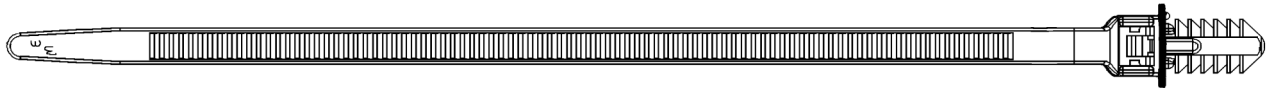

(OE# NOT AVAILABLE)

**PUSH MOUNT CABLE TIE- BLACK (50 LB TENSILE STRENGTH)
FOR 1/4"(6.3MM) HOLE; 8.6"(219 MM) LONG; FOR 2"(51 MM) MAX. BUNDLE DIAMETER
UNIVERSAL USE
UNIT PKG.-25**

3434



**(91516-SK7-003; 91516-SK7-013;
REPL.NISSAN 01553-00344; 01553-0034U)
PLASTIC SCREW RIVET , BUMPER COVER &
SPLASH SHIELD RETAINER**

**(FOR 8 MM HOLE; 20MM HEAD DIAM.;
15 MM STEM LENGTH)**

**HONDA/ACURA- CIVIC,
CR-V & INTEGRA
1994-UP
UNIT PKG.-10**

3435



(76924-12030)

**PLASTIC ROCKER MOULDING
AND MUDGUARD RETAINER**

**(FOR 17 X 25 MM HOLE; HEAD- 28X37 MM.;
O/A HEIGHT 13 MM)**

**TOYOTA-COROLLA 2014- UP
SCION IQ 2012- UP**

UNIT PKG.-25

3436

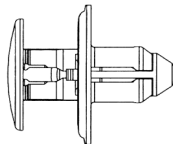

(11612035)

**PLASTIC PUSH RIVET LOWER ENGINE COVER,
BUMPER COVER & FENDER LINER**

**(FOR 8.5 MM HOLE; 20 MM HEAD DIAM.;
22 MM PIN LENGTH)**

**CHEVY.-CAPRICE, IMPALA, MALIBU & SS; GMC-
COLORADO & CANYON P/U; CADILLAC ELR;
BUICK CASCADE
GM- 2014-UP**

UNIT PKG.-25

3438

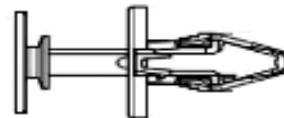

(W718088-S300)

PLASTIC PUSH RIVET FENDER LINER RETAINER

**(FOR 7 MM HOLE; 18 MM FLANGE DIAM.; 20 MM STEM
LENGTH; 3 MM GAP AT PIN HEAD)**

**FORD FUSION
2015-UP
UNIT PKG.-25**



NEW ITEMS BULLETIN NO. 86

370 ELIZABETH AVENUE, NEWARK, NJ 07112
(973) 824-2000 FAX (973) 824-7382

WWW.WESALES.COM

OCTOBER, 2017

3439



(76882-EG01A)
**PLASTIC ROCKER MOULDING
RETAINER WITH SEALER**
(FOR 8MM HOLE; 10 X 15 MM TOP
HD; 18MM FLANGE; 18 MM O/A HT)

INFINITY- QX50 2016- UP
NISSAN- ALTIMA, 370Z, JUKE
2009- UP

UNIT PKG.-15

3440



(76882-EWOOB)
**PLASTIC ROCKER MOULDING
RETAINER WITH SEALER**
(FOR 8 MM HOLE; 6 X 9 MM TOP
HEAD; 13 MM FLANGE O.D.;
12 MM OVERALL HEIGHT)

NISSAN-ALTIMA, JUKE- 2011-UP
INFINITY-QX50- 2016- UP

UNIT PKG.-10

3441



(01281-00711)
**PLASTIC SCREW GROMMET
W/ SEALER- ROCKER PANEL,
INT. TRIM & BUMPER COVER**
(FOR 4.2-4.8MM(#8-10) SCREW;
13 MM HOLE; 20 MM FLANGE;
17 MM OVERALL HEIGHT)

NISSAN-MOST MODELS
INFINITY-JX35, Q SERIES
2013-UP
UNIT PKG.-10

3442

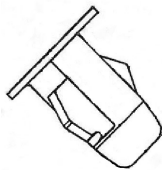

(90189-06076; 90189-06081)
**PLASTIC SCREW GROMMET-
SPLASH SHIELD**
(FOR 5.5 MM (#12 SCREW)
(FITS 9 MM SQ. HOLE; 16 MM
FLANGE; 18 MM OVERALL HEIGHT)

TOYOTA- YARIS, SCION XB & XD
2008- UP

UNIT PKG.-25

3443

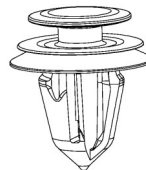

(11546850)
**PLASTIC MOULDING RETAINER-
FRONT & REAR WHEELHOUSE**
(FOR 8.5 MM HOLE; 13 MM TOP HD
DIAM.; 13 MM LOWER FLANGE
O.D.; 21 MM OVERALL HEIGHT)

GM- SIERRA, C/K ,
BUICK- ENVISION
2014- UP

UNIT PKG.-50

3444



(90920-7031)
**PLASTIC HOOD
INSULATION RETAINER**
(FOR 7 MM HOLE; 23 MM HEAD
DIAM.; 17 MM OVERALL HEIGHT)

SUBARU-FORESTER, XV
CROSSTEK, BRZ & WRX
2013- UP

UNIT PKG.-50

3445



(57371-GA070)
**PLASTIC CABLE CLIP - HOOD
RELEASE CABLE & OTHERS**
FOR 5 MM DIAM. CABLE
(FITS 6 MM HOLE; 15 MM
OVERALL HEIGHT)

SUBARU- FORESTER, OUTBACK,
LEGACY, XV CROSSTEK & BRZ
1995- UP

UNIT PKG.-25

3446

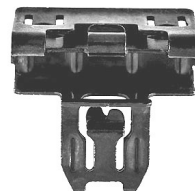

(11547446)
DOOR PANEL RETAINER
(16 X 25 HEAD; 23 MM
OVERALL HEIGHT)

GM/GMC- ARCADIA, CADILLAC,
C/K; CHEVY., COLORADO &
CANYON
2014- UP

UNIT PKG.-10

3447



(W718365-S300)
**PLASTIC PUSH RIVET- FENDER
LINER & MUD GUARD RETAINER**
(FOR 8.5 MM HOLE; 25 MM HEAD
DIAM.; 24 MM STEM LENGTH)

**FORD-MUSTANG, TRANSIT
CONNECT; LINCOLN-MKC**
2014- UP

UNIT PKG.-10

3448



(90467-05170)
**PLASTIC PUSH RIVET-
BUMPER COVER RETAINER**
(FOR 5 MM HOLE; 10 MM FLANGE
DIAMETER; 10 MM STEM LENGTH)

**TOYOTA /LEXUS- COROLLA,
HIGHLANDER, MATRIX, RAV 4,
IS 250, 350 & 300H
2012- UP
UNIT PKG.-25**

3449



(11547024)
**DOOR SILL & INT. PANEL
RETAINER WITH SEALER**
(FOR 8 MM HOLE; 17 X 20 MM TOP
HEAD; 16 MM OVERALL HEIGHT)

**GM- CADILLAC, BUICK, CHEVY.,
2013- UP**

UNIT PKG.-10

3450



(90189-A0011)

**FENDER LINER SCREW
GROMMET- #12 SCREW**
(FOR 9 MM SQ. HOLE; 18 MM FLANGE O.D;
18 MM O/A LENGTH)

**TOYOTA -CAMRY & OTHER
MODELS
1997- UP**

UNIT PKG.-15

3451



(76924-02020)
**PLASTIC RETAINER- ROCKER
MOULDING & MUD GUARD**
(FOR 22 MM HOLE; 32 MM
HEAD DIAMETER)

**TOYOTA -PRIUS C
2012- UP
UNIT PKG.-25**

3452

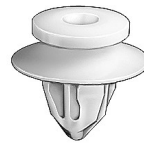

(90467-A0007; 90467-10162)
ROCKER MOULDING RETAINER
(FOR 8 MM HOLE; 13 MM TOP
HEAD DIAM.; 18 MM FLANGE;
16 MM OVERALL LENGTH)

**TOYOTA -PRIUS C & OTHERS
2012- UP
UNIT PKG.-15**

3453



(90467-07215)

**PLASTIC PUSH RIVET-RADIATOR
& SPLASH SHIELD REATAINER**
(FOR 7 MM HOLE; 20 MM FLANGE OD;
11MM STEM LENGTH)

**TOYOTA - COROLLA
2014- UP
UNIT PKG.-20**

3454

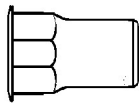

**M8 - 1.25 HEX HEAD
THREADED INSERT-STEEL**

(FOR 13 MM HOLE; 16.7 MM A/F;
0.7- 3.8 MM PANEL RANGE)

ZINC/YELLOW PLATED

UNIT PKG.-15

3455

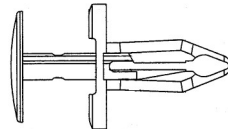

(6510139AA)
**PLASTIC PUSH RIVET-
FENDER LINER RETAINER**
(FOR 7 MM HOLE; 18 MM FLANGE
DIAM.; 18 MM STEM LENGTH)

**CHRYSLER/DODGE- 300,
CHALLENGER, CHARGER &
VIPER- 2011- UP
UNIT PKG.-25**

3460



(53857-0E010)

**FRONT FENDER RETAINER
WITH SEALER**

(FOR 9 MM HOLE; 20 MM TOP HD DIAM.; 18
MM FLANGE DIAM.; 32 MM O/A LENGTH)

**TOYOTA - HIGHLANDER
2014- UP
UNIT PKG.-10**

3467

(25704358)



**PLASTIC BUMPER GROMMET
WITH SEALER,**

(FOR 10 X 14 MM HOLE; TAKES 6.3MM (1/4")
SCREW; 15 X 18 MM HD; 24 MM O/A LGTH)

**GM- PONTIAC, CADILLAC,
CHEVY- 2004- UP
UNIT PKG.-10**

3464



(90913-0096)
**PLASTIC RETAINER-HEADLINER
WINDSHIELD, CENTER PILLAR,
FRONT & REAR SILLS**
(FOR 8 MM HOLE; 13 MM TOP HD
DIAM.; 15 MM BOTTOM FLANGE
DIAM.; 17 MM O/A LENGTH)

**SUBARU- VARIOUS MODELS
2005- UP
UNIT PKG.-25**

3465



(OE N/A)
**PLASTIC MOULDING CLIP-
WHEEL WELL**
(FOR 9 MM HOLE; 15 X 34 MM
TOP HEAD; 14 MM STEM LENGTH)

**FORD- F-250, 350SD, F-450, F-550
2008- UP**

UNIT PKG.-10

3468



(1588818)
**PLASTIC MOULDING RETAINER-
WHEEL OPENING**

(FOR 9 MM HOLE; 16 X 26 MM TOP HD;
14 X 20 LOWER FLANGE; 22 MM O/A LGTH)

**GM/GMC-CADILLAC, BUICK,
CHEV.
2013- UP
UNIT PKG.-10**











NEW ITEMS BULLETIN NO. 87

370 ELIZABETH AVENUE, NEWARK, NJ 07112
 (973) 824-2000 FAX (973) 824-7382

WWW.WESALES.COM

SEPTEMBER, 2018

<p>3456</p>  <p>(91514-T0A-A01) PLASTIC PUSH RIVET FENDER MOULDING RETAINER (FOR 6 MM HOLE; 10 MM HD DIAM; 8 MM STEM LENGTH)</p> <p>HONDA- CRV & PILOT 2012- UP</p> <p>UNIT PKG.-20</p>	<p>3458</p>  <p>(53857-12010) FRONT FENDER MOULDING RETAINER WITH SEALER (FOR 6 MM HOLE; 20 X 30 MM HEAD; 10 MM STEM LENGTH)</p> <p>TOYOTA/LEXUS VARIOUS MODELS 2015- UP</p> <p>UNIT PKG.-15</p>	<p>3459</p>  <p>(67869-22010) WEATHERSTRIP RETAINER FRONT DOOR (10 MM HEAD DIAMETER; 13 MM STEM LENGTH)</p> <p>TOYOTA -CAMRY & AVALON 2013- UP</p> <p>UNIT PKG.-25</p>
<p>3461</p>  <p>(52599-48020) REAR BUMPER RETAINER WITH SEALER & STAINLESS SCREW (22 MM HEAD DIAM.; 13 MM SHLDR DIAM.; 27 MM STEM LGTH)</p> <p>TOYOTA -HIGHLANDER-2001- 2007 & VENZA- 2009-UP</p> <p>UNIT PKG.-5</p>	<p>3462</p>  <p>(88796-6P000) PLASTIC SCREW GROMMET WITH SEALER (FOR 9 MM SQ.HOLE; TAKES M4.8- 6.0(#10-#12 SCREW); 16 MM HD DIAM.; 16 MM O/A LENGTH)</p> <p>NISSAN- ROGUE/FRONTIER 2007- UP</p> <p>UNIT PKG.-15</p>	<p>3463</p>  <p>(01553-10641) INTERIOR DOOR PANEL & EXTERIOR TRIM RETAINER (FOR 8 MM HOLE; 13 MM TOP HD DIAM.; 18 MM BOTTOM FLANGE DIAM.; 22 MM O/A LENGTH)</p> <p>NISSAN- ROGUE & VERSA INFINITY-FX & QX 2009- UP</p> <p>UNIT PKG.-25</p>
<p>3466</p>  <p>(11518531) RETAINER- FENDER, BUMPER COVER, HOOD, HEADLAMP & INTERIOR TRIM FOR#8(M 4.2- 1.41) SCREW ZINC</p> <p>VARIOUS GM/GMC, BUICK CHEVY. & CADILLAC 2003- UP</p> <p>UNIT PKG.-15</p>	<p>3468</p>  <p>(11588818) PLASTIC MOULDING RETAINER WHEEL OPENING (FOR 9 MM HOLE; 16 X 26 MM TOP HD; 14 X 20 LOWER FLANGE; 22 MM OVERALL LENGTH)</p> <p>GM, CADILLAC, BUICK & CHEVY 2013- UP</p> <p>UNIT PKG.-10</p>	<p>3469</p>  <p>(11561329; REPL.,11610006) PLASTIC BUMPER COVER & ROCKER MOULDING RETAINER (FOR 9 MM HOLE; 18 X 20MM TOP HD; 24 MM O/A LENGTH)</p> <p>GM, CADILLAC-STS, CHEVY- CORVETTE, HUMMER-H3T 2005- UP</p> <p>UNIT PKG.-10</p>

PRG-80

(REPLACES #PRG-30)

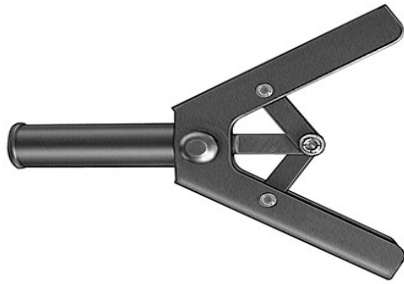

PLASTIC BLIND RIVETING TOOL
All steel construction; pulls all W&E plastic blind rivets.
(NOT FOR USE WITH METAL RIVETS)

UNIT PKG.-1

3470



(91513-TK8-A01)
PLASTIC EXTERIOR TRIM
RETAINER WITH SEALER
(FOR 8 MM HOLE; 11 X 12 MM TOP HD
DIAM.; 27 MM O/A LENGTH)

HONDA-2011- UP
ODYSSEY & RIDGELINE

UNIT PKG.-25

3471



(91561-TA5-A11;91561-TA0-A11)
PLASTIC GROMMET W/METAL
PIN-INTERIOR PILLAR TRIM CLIP
(FOR 9 MM HOLE; 18 MM TOP HD
DIAM.; 38 MM O/A LENGTH)

HONDA-2008- UP
ACCORD, FIT, CR-Z, CIVIC,
ODYSSEY, PILOT, RIDGELINE
& INSIGHT

UNIT PKG.-5

3472

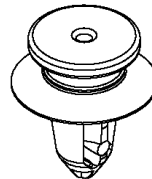

(11547574;REPL.11610605)
PLASTIC DOOR & INTERIOR
TRIM RETAINER
(FOR 7.5 MM HOLE; 13 MM TOP HD
DIAM.; 17 MM LOWER FLANGE
DIAM.; 21 MM O/A LENGTH)

GM-2011- UP; VARIOUS
MODELS-BUICK,CADILLAC,
CHEVY & GMC

UNIT PKG.-25

3473



(91514-SMG-E01)
PLASTIC MOULDING CLIP W/
SEALER- TAILGATE & SPOILER
(FOR 10 MM HOLE; 12 X 17 MM TOP
HD DIAM.; 28 MM O/A LENGTH)

HONDA-2010- UP
CR-V, CIVIC, ODYSSEY, PILOT
& CROSSTOUR

UNIT PKG.-15

3474



(90467-A0032)
PLASTIC RETAINER- LOWER
DOOR MOULDING W/SEALER

(FOR 7 MM HOLE; 16 MM
OVERALL LENGTH)

TOYOTA RAV4- 2014-UP

UNIT PKG.-25

3475



(62955-50010)
PLASTIC ROCKER EXT. MLDG
RETAINER W/ SEALER
(FOR 7MM HOLE; 8 X 8 MM TOP HD
DIAM.; 11 MM STEM LENGTH)

TOYOTA/LEXUS- 2013-UP
RAV4, HIGHLANDER & YARIS
LEXUS-ES, HS, LS & RX

UNIT PKG.-25

3476



(53145-12010)
PLASTIC RADIATOR
GRILLE RETAINER
(36 MM WIDE; O/A LENGTH 38 MM)

TOYOTA -1993- UP
COROLLA, FJ CRUISER &
TACOMA

UNIT PKG.-15



NEW ITEMS 2019

370 ELIZABETH AVENUE, NEWARK, NJ 07112
(973) 824-2000 FAX (973) 824-7382

WWW.WESALES.COM

3477
(6510123AA)



PLASTIC GROMMET & SCREW ASSEMBLY-ROCKER PANEL & SPLASH SHIELD
(FOR 10 X 12 MM HOLE; 18 MM HD DIAM; 38 MM O/A GROMMET LGTH)
DODGE-CHALLENGER & RAM, CHRYSLER PACIFICA & JEEP CHEROKEE
2011- UP
UNIT PKG.-5

3478



(68283229AA)
PLASTIC ROCKER MOULDING RETAINER WITH SEALER
(FOR 9 MM HOLE; 14 X 20 MM TOP HD; 14 X 32 MM BOTTOM HD; 21 MM OVERALL LENGTH)
CHRYSLER 300 & DODGE CHARGER
2015- UP
UNIT PKG.-10

3479



(90672-SNA-A01)
HOOD PROP ROD RETAINER
(FOR 8 MM ROD DIAM.; 27 MM OVERALL LENGTH)
HONDA- CIVIC, FIT & ODYSSEY
2006- UP
UNIT PKG.-25

3480



(11546635;REPL.11612122)
PLASTIC ROCKER MOULDING RETAINER WITH SEALER
(FOR 9 MM HOLE; 10 X 20 MM TOP HD; 14 X 20 MM BOTTOM FLANGE; 20 MM O/A LENGTH)
GM/ GMC- ARCADIA; CHEVY. CAMARO, EQUINOX & TRAVERSE; CADILLAC-ATS, CTS & ETS-2013- UP
UNIT PKG.-10

3481



(75867-68010)
PLASTIC WHEEL OPENING MOULDING & ROCKER PANEL RETAINER
(FOR 8.5 MM HOLE; 13 MM TOP HD; 18 MM FLANGE; 19 MM OVERALL LENGTH)
TOYOTA- RAV4, PRIUS & CAMRY
2013- UP
UNIT PKG.-50

3482



(W525157-S300)
3/16"(4.8 MM) ALUMINUM RIVET/ STEEL MANDREL- BUMPER AND LOWER AIR DEFLECTOR
(3/8" FLANGE; 1/8-1/4" GRIP)
FORD & GENERAL USE
UNIT PKG.-50

3483



(91560-TL0-G210)
PLASTIC RETAINER-REAR SPOILER ASSEMBLY W/SLR
(FOR 8.5 MM HOLE; 13 MM TOP HD DIAM.; 18 MM FLANGE DIAM.; 18 MM OVERALL LENGTH)
HONDA/ACURA- ACCORD, CR-V, ODYSSEY, INSIGHT, TSX, TLX, RLX, RDX & ILX
2009- UP
UNIT PKG.-15

3484



(68146440AA)
PLASTIC WHEEL FENDER FLARE RETAINER
(FOR 10 X 16 MM HOLE; 13 X 31 MM HEAD; 27 MM OVERALL LENGTH)
DODGE-RAM
2011- UP
UNIT PKG.-15

3485



(91560-TG1-T010)
PLASTIC RETAINER WITH SEALER-DOOR PANEL, TRIM MOULDING & SILL PLATE
(FOR 8.5 MM HOLE; 13 MM TOP HD DIAM.; 18 MM LOWER FLANGE; 18 MM OVERALL LENGTH)
HONDA/ACURA- ACCORD, ACCORD HYBRID, CIVIC, CR-V, HR-V, ODYSSEY, PILOT & RIDGELINE; TLX & MDX
2013- UP
UNIT PKG.-15

3486



**(55075139; REPLACE GM-
10089262; GM-21042098)
PLASTIC TORX HEAD-(T-20)
SCREW RIVET- TRIM, TRUNK
PANEL RETAINER
(FOR 6 MM HOLE; 11 MM FLANGE
DIAM.; 18 MM STEM LENGTH)
DODGE-RAM TRUCKS;
JEEP CHEROKEE
2009- UP
UNIT PKG.-25**



“YOU CAN’T DO BUSINESS FROM AN EMPTY WAGON!”

WWW.WESALES.COM

**YOUR AUTOMOTIVE HARDWARE CONNECTION
FOR OVER 80 YEARS**